



Husqvarna®



PRODUCT CATALOGUE 2019



PREPARE FOR ANY CHALLENGE

As a professional contractor you never know exactly what your next assignment will be, or what the workplace will look like. You may just have some details about what materials to cut, drill, grind or demolish, so you can judge what equipment and tools to use. At Husqvarna, we see it as our mission to help you prepare your machine fleet for any challenge and also support you when something unexpected happens.

With Husqvarna you get access to a broad range of powerful equipment and diamond tools for most types of jobs, all available in one place. You get a choice of systems designed around you, to help you finish any job as quickly, efficiently and profitably as possible. And you get a partner that understands your business well enough to support you in any possible way. Together we will explore the smarter ways to work.



COMPACTION EQUIPMENT

18

CONCRETE PLACEMENT EQUIPMENT

28

EARLY ENTRY SAWING

42

DIAMOND TOOLS EARLY ENTRY SAWING

45

SURFACE PREPARATION

46

DIAMOND TOOLS FOR SURFACE PREPARATION

54

DUST AND SLURRY MANAGEMENT

64

WALL SAWING

74

DIAMOND TOOLS FOR WALL SAWING

82

WIRE SAWING

88

DIAMOND TOOLS FOR WIRE SAWING

94

FLOOR SAWING

96

DIAMOND TOOLS FOR FLOOR SAWING

102

DRILLING

108

DIAMOND TOOLS FOR DRILLING

120

HANDHELD POWER CUTTING

130

DIAMOND TOOLS FOR HANDHELD POWER CUTTING

140

DIAMOND TOOLS FOR ANGLE GRINDERS

150

BATTERY PRODUCTS

154

MASONRY AND TILE SAWING

160

DIAMOND BLADES FOR MASONRY AND TILE SAWING

166

REMOTE DEMOLITION

168

TOOLS FOR DEMOLITION ROBOTS

174

CONTACT INFORMATION

178

WE'LL KEEP YOU INFORMED ONLINE!

VISIT OUR WEBSITE Here you'll find updated information on our machines and diamond tools, including complete product technical data, service literature, user manuals, an interactive tool guide, news and much more. You'll also find news and information from our company and your local organisation, such as Service Centres and authorised dealers.
www.husqvarnacp.co.uk

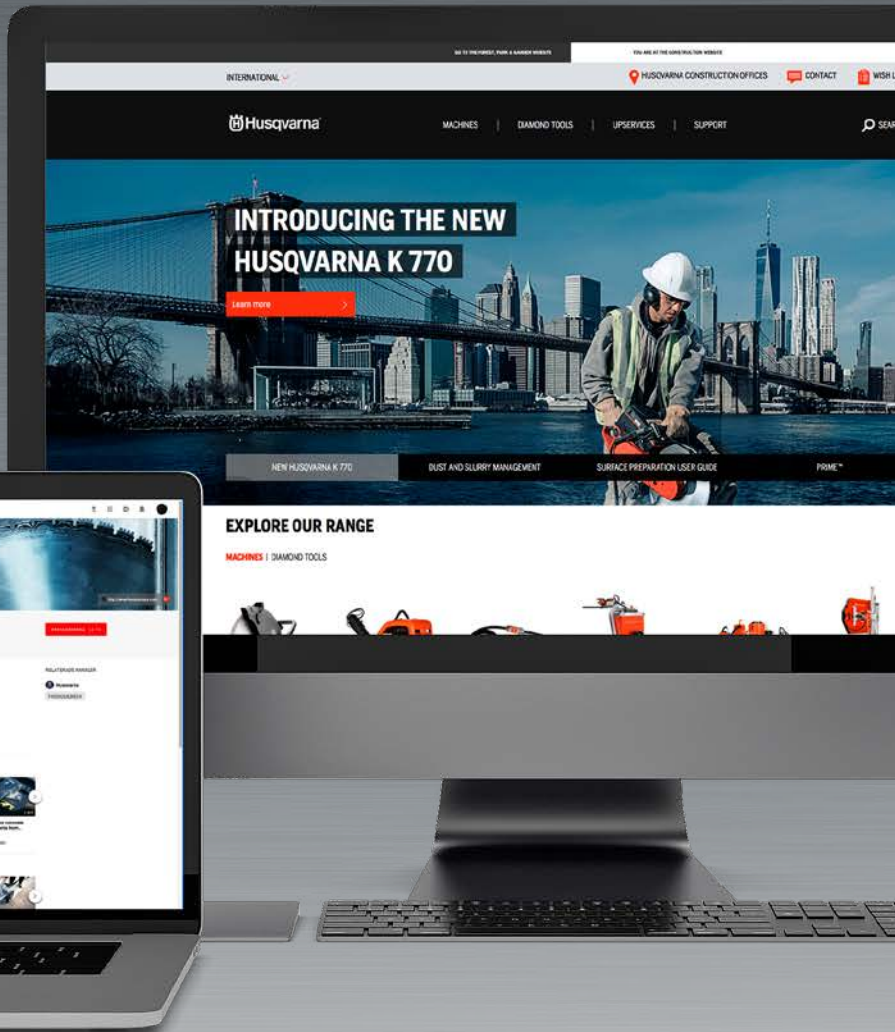

SUBSCRIBE TO OUR YOUTUBE CHANNEL Watching our high-quality videos is one of the best ways to find out about the features and benefits of our products, as well as getting useful tips and hints on usage, maintenance and repair procedures for your Husqvarna equipment. Stay tuned for our latest video updates by subscribing to our YouTube channel! www.youtube.com/HusqvarnaCP

PICK UP YOUR SMARTPHONE Our mobile website provides constant access to updated product information and useful support for your equipment, including an interactive tool guide to help you find the right tool for your job, a library of instructional videos, a searchable archive of user manuals for the machines in PDF format, and contact details of all our dealers.

Available on the
App Store



DOWNLOAD THE CONSTRUCTION MAGAZINE

Get the industry's most interesting app for your iPad! Browse our complete range of Husqvarna equipment, diamond tools and services, find the latest technical specifications for your favourite Husqvarna equipment, watch instructive videos and get inspired by interesting case stories from the world community of Husqvarna users. Available for free download on App Store.

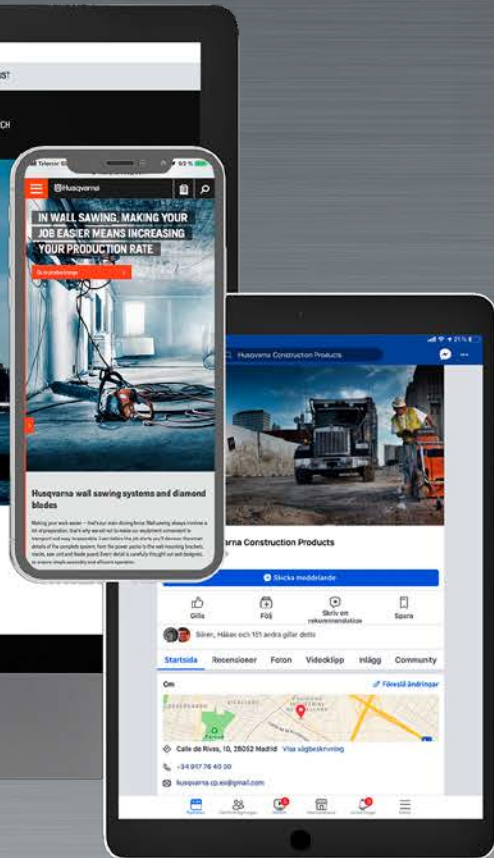

FOLLOW US ON FACEBOOK Don't miss if you're in business! On our Facebook page you can get in touch with us at Husqvarna, and meet Husqvarna users from all over the world. Tell us what you think of our products and services, share your own stories and view pics and videos from our exhibition shows and other Husqvarna events.
www.facebook.com/HusqvarnaConstructionUK

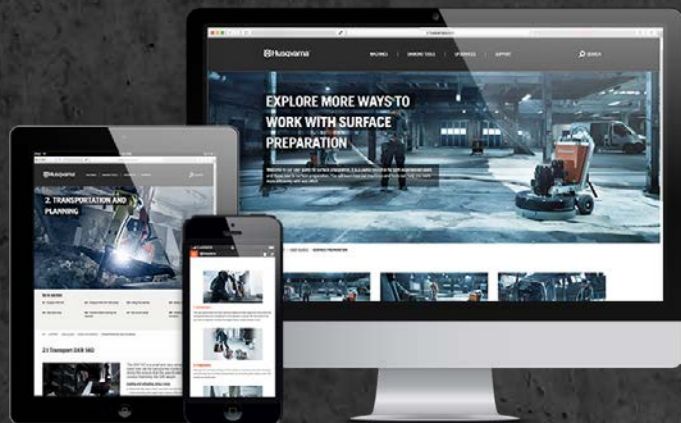

USER GUIDES ONLINE

Ever wondered how to get the most out of your Husqvarna equipment? Then it's time to visit the UpServices section on our website! There you'll find our interactive user guides, packed with short video clips showing best practice. The place to go to learn and be inspired! (Memorising the Operator's manual first is of course mandatory too).

NEW HUSQVARNA PRODUCTS FOR 2019

NEW! CONCRETE PLACEMENT EQUIPMENT

Husqvarna's new range of equipment for concrete placement covers all steps in the process – including vibrating, levelling and surfacing of poured concrete surfaces and floors. The range includes both electric and petrol-powered vibrators, screeds and trowels, counting to a total of 74 different models. All conveniently available from one source.



NEW! COMPACTION EQUIPMENT

Husqvarna now launches a complete range of light compaction equipment for all soils and pavements, including rammers, forward plates for soil and asphalt, forward and reversible plates and double drum rollers – no less than 51 different models in total. Each machine is developed for maximum productivity, performance and durability.



NEW!
HUSQVARNA W 70 Our iconic wet and slurry vacuum, known for its long, trouble-free service life, is now available in a version without built-in evacuation pump. Emptying is carried out via a large bottom valve for simple cleaning. Where most wet vacs can only handle water, W70 can deal with liquids such as concrete slurry, oils and machining coolants.



NEW!
HUSQVARNA T 4000 A new, effective 3-phase industrial dust extractor developed to match the grinding machines Husqvarna PG 530 and PG 450 as well as small to medium scarifiers, shot blasters and shavers. The quiet, yet powerful turbine motor delivers exceptional airflow. Two individual tested and certified HEPA filters, class H13, and a massive cone-shaped pre-filter provides nonstop grinding and a long service life.

NEW HUSQVARNA PRODUCTS FOR 2019



NEW!

SLURRY COLLECTOR RINGS An ideal attachment for wet core drilling in floors, walls and roofs – no mess! Simply attach it to a powerful slurry vac like Husqvarna W70 P. Then place it around the core bit, and the vacuum makes it adhere securely to any flat surface – even on the roof! Made from durable heavy-duty clear plastics so you can see the removal process easily. Available in five different sizes for core bits up to 350 mm diameter.

NEW!

HUSQVARNA SHARX™ SURFACE PREP TOOL A new Redi Lock® tool developed for fast and easy removal of dense surfaces on hard-troweled concrete floors. Sharx™ features the softest metal bond ever developed by Husqvarna for dry grinding applications, together with a mix of diamonds that is optimised for high productivity.



NEW! **HUSQVARNA K 770 VAC**

Taking its momentum from the first-class cutting experience of the Husqvarna K 770 power cutter, the K 770 VAC has been developed to bring cutting efficiency to those places where wet cutting isn't an option. With an easy-to-operate dust collector and hose, you'll be able to collect the cutting dust with the use of an external dust extractor. The need for preparing the work site or cleaning is minimised, freeing you from additional work.

READY.

SET.

DONE.

Easy to start with cordless convenience, minimal noise and free from direct emissions and smoke.

On top of that the benefits of low maintenance and our one-battery powered system, it doesn't get more convenient than that. Quick, easy, flexible and effective.

No matter if you need to cut, blow or trim – there is always a machine for you. Get ready to experience the freedom of Husqvarna Battery-powered equipment."

NEW HUSQVARNA K 535i CUT AWAY – WITHOUT FUEL OR EMISSIONS

Experience battery-powered convenience with excellent cutting performance with the new Husqvarna K 535i. Based on Husqvarna's established battery motor platform, this lightweight 36 V, 9" power cutter provides you with reliable quick starts and frees you up from depending on petrol or grid power. The machine is easy to manoeuvre and control, thanks to the placement of the blade closer to the centre of the machine. As an added bonus, you can cut away without worrying about emissions.

READ MORE ABOUT OUR BATTERY RANGE ON PAGE 154







Husqvarna



SERVICE, SUPPORT AND SOLUTIONS DESIGNED AROUND YOU – AND YOUR BUSINESS

At Husqvarna Service Centres you can always expect to meet service-minded and knowledgeable staff who provide world-class service, support and business solutions designed around you. That's how we offer problem-free ownership with maximum uptime.

It means you can focus on your business, your clients and your staff. With a broad supplier and long-term service partner like Husqvarna, you get one point of contact for all your equipment. To put it simply, you get everything at one place.

To be able to offer fast and correct service and repair at our service centres, we have developed a state-of-the-art process that uses the latest technology. This is a cornerstone in our goal to provide you with the best service experience in the business.

PROTECTIVE EQUIPMENT THAT MAKES YOUR WORK SAFER AND MORE CONVENIENT

In our wide range of protective equipment you will find products aimed at making your job safer, more convenient and more practical – so you can always achieve the best possible results.



SOFT SHELL JACKET Wind and water repellent soft shell jacket made of a comfortable, stretchy membrane with a soft fleece lining. Perfect for different types of weather, over other clothing or on its own. Cordura reinforcement over shoulders, on back of sleeves and on sides. Sleeves are pre-curved for greater comfort and ease of movement. Adjustable lower parts and cuffs. Four zippered pockets at front and two inside pockets. 577 25 30-xx Size 46–58.



GLOVES, CLASSIC A one size durable glove made with a goat leather palm with spandex fabric on the back. Goat leather provides good protection against moisture as it contains natural fat and is therefore suitable for demanding jobs. Rubberised cuff with cotton binding for a perfect fit around the wrist. 579 37 99-10

PROTECTIVE GLASSES, CLEAR X Protective glasses with non-scratch, clear lenses, extendable frames and lenses that can be angled. Approved as per EN 166 and Ansi Z87+. 544 96 37-01



HEARING PROTECTION WITH FM RADIO Hearing protection with FM-radio, improved sound quality and a well designed headband that gives less pressure on your ears. The earmuffs are specially designed to follow the shape of the head, which give a perfect fit. Equipped with 3.5 mm audio input (AUX) for MP3, and communication radio. 578 27 49-01 (with headband). 578 27 49-04 (helmetbased).

HEARING PROTECTION WITH HEADBAND Comfortable and lightweight with a flexible padded headband. Design allows 20% adjustment of pressure. Approved according to current EN standards. 505 66 53-04

WE'RE EXPERTS IN DIAMOND TOOLS – SO YOU DON'T HAVE TO BE

Husqvarna is one of the world's leading developers and manufacturers of diamond tools for cutting and drilling in concrete and other construction materials. We supply millions of diamond tools – saw blades, drill bits, wires and grinding tools – to professional contractors, craftsmen and rental companies all over the world. A Husqvarna diamond tool is always a safe choice. If you're not sure which tool to pick for a specific job, just follow our recommendation charts or consult your Husqvarna sales contact.



For more information, visit www.husqvarnacp.co.uk

Diamond tools for any requirement.

If you're a concrete cutting specialist working full-time with cutting and drilling, you have other demands on the diamond tools compared to a paving or pipe laying contractor. To help you find the best tool for your job, Husqvarna diamond tools come in three performance categories: Gold, Silver and Bronze.

GOLD

Husqvarna Gold level diamond tools are developed for specialist contractors. Made for intensive professional use in specialist applications. Provide maximum cutting speed and wear resistance in heavy cutting, grinding and drilling.

SILVER

Husqvarna Silver level diamond tools are developed for general contractors. Made for professional use in all-round applications. Provide high cutting speed and wear resistance in all cutting, grinding and drilling.

BRONZE

Husqvarna Bronze level diamond tools are developed for occasional users. Made to provide a good balance between performance and price in all common cutting and drilling applications.

Recommendation chart.

For cutting in harder materials, a tool with softer bond works best because the diamonds are exposed faster, which means faster cutting. When working in softer or more abrasive materials, a tool with harder bond works best because of greater resistance to abrasion.

The tool's suitability for different materials is indicated by the following scale:

- ● ● = Optimal
- ● = Good
- = Acceptable
- = Not recommended

Recommendation charts can be found in the product tables and also in the interactive Tool Guide available on our website.

For handheld applications, the tool packaging clearly shows which material the blade is optimised for.





Tools and equipment developed together.

If you want to ensure that you get the most out of your Husqvarna equipment, use it with Husqvarna diamond tools. We see the diamond tool, the machine and the user as a whole that must work optimally together. This view is an important foundation of our product development.

SOFF-CUT BLADES – PAGE 45

- XL14 series
- XL10 series
- XL6 series

FLOOR GRINDING AND POLISHING TOOLS – PAGE 54

- Elite-Grind series
- Vari-Grind series
- Piranha™
- Sharx™ – NEW!
- Polishing tools
- Ceramic dry grinding and polishing tools
- Maintenance pads
- Cup wheels
- Floor treatment products
- Scarifying tools

WALL SAWING BLADES AND CHAINS – PAGE 82

- W 1500 Diagrip™ series – NEW!
- PRO series chains for WSC 40

WIRE SAWING WIRES – PAGE 94

- Vacuum-brazed wires
- Sintered wires

FLOOR SAWING BLADES – PAGE 102

- F 1500 Diagrip™ series
- F 1570 series
- L 600 series
- Elite-Cut series
- Vari-Cut series
- Tacti-Cut series

CORE DRILL BITS – PAGE 120

- Elite-Drill series
- Vari-Drill series
- Tacti-Drill series
- D 05
- D 25

HANDHELD POWER CUTTING BLADES – PAGE 140

- Elite-Cut series
- Vari-Cut series
- Tacti-Cut series
- S 1400 Diagrip™ series
- Diamond tools for deep cutting
- Diamond tools for angle grinders
- Battery power cutter series – NEW!

TILE SAWING BLADES – PAGE 166

- Elite-Cut series
- Tacti-Cut series

BRING COMPACTION TO A NEW LEVEL

Husqvarna's compaction equipment is developed for maximum productivity, performance and durability. Every little detail in your machine – from the ergonomic, vibration-damped handles to the hard, wear-resistant steel surface beating the soil – is designed to get the job done with maximum uptime and minimum service requirement. By designing the products for easy handling and reduced vibration in hands and arms we help you stay concentrated and sharp for the whole working day.

Range overview.

Husqvarna offers a complete range of compaction equipment for all soils and pavements, including tamping rammers, forward plate compactors for soil and asphalt, reversible plate compactors, and duplex rollers – no less than 51 different models in total.

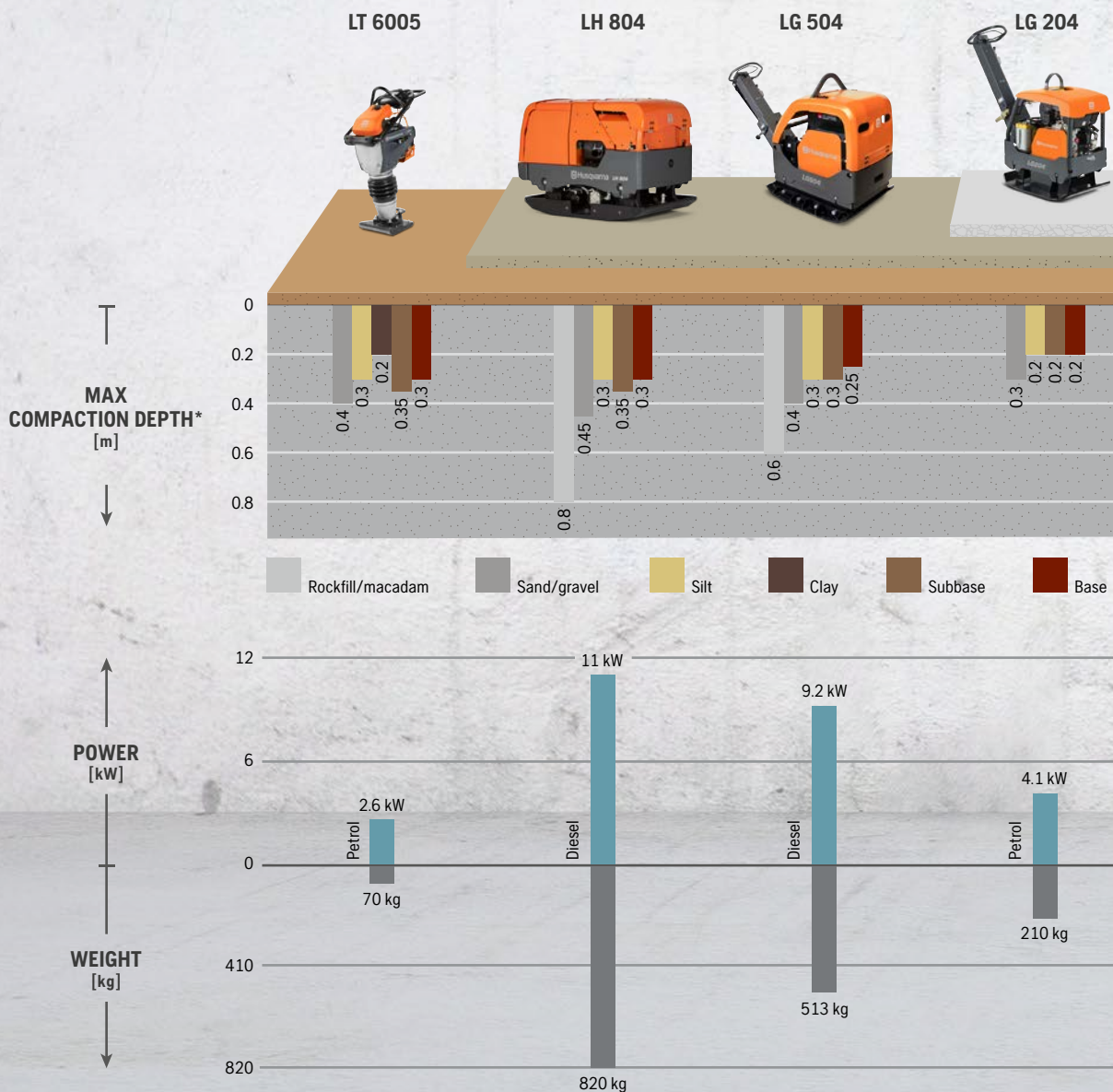

ERGONOMICS ADD EFFICIENCY

The vibration damping handle allows you to work efficiently for hours.

KNOW WHEN YOU'RE DONE The optional compaction indicator tells you when the ground is ideally compacted and when it's time to move on to the next task.

EASY OPERATION The forward/reverse lever and fixed handle grip makes handling easy on all surfaces. You don't have to push/pull constantly during operation.



SERVICE MADE EASY All service points are easily accessible.

MORE UPTIME The heavy-duty protection frame with impact-resistant covers will protect both engine and transmission.

WEAR RESISTANT The bottom plates on the LG-range are made from an extremely robust and wear resistant steel quality called Hardox 400.

GETTING THE JOB DONE JUST RIGHT – THE FIRST TIME The optional Compaction Indicator available for Husqvarna LG 400 and LG 504 helps save both time and money. A clear system of indicator lights shows when sufficient compaction has been achieved. This also reduces the risk of over-compaction, which can lead to unsatisfactory end results and unnecessary wear on the machine. Together, your skills and the Compaction Indicator will master any soils or rockfill berths.



LF 130 LT



LF 50 L



LF 80 LAT



LP 6505



* Maximum depth at 4 passes / LP rollers at 8 passes.

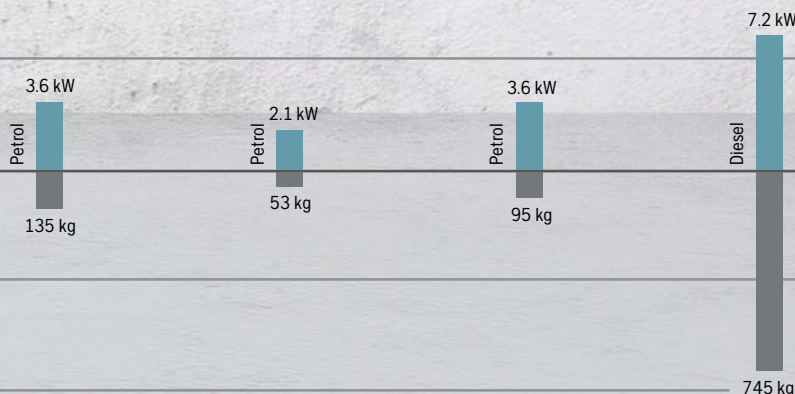

For more information, visit www.husqvarnacp.co.uk

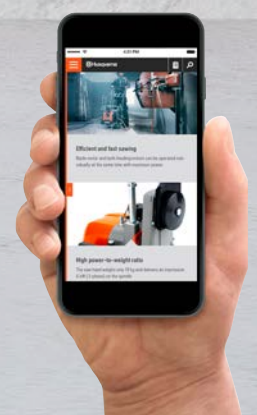

KNOWING YOUR SOIL AND SURFACE WILL HELP YOU CHOOSE THE BEST EQUIPMENT

Soil has been around for millions of years and is created by force of nature. Here's how you'll manage to tame Mother Nature's upper crust.



CLAY – STICKS TOGETHER

Clay particles stick together and you need high impact force to get the air out. Proper moisture is important when compacting. Wet clay can be molded while dry clay becomes very hard and may crack under pressure. Husqvarna LT rammers are able to transmit the high pressures and shear forces necessary to compact clay at or below optimum water content.

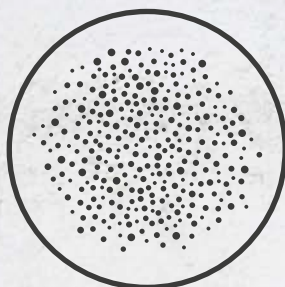

SILT – NEEDS FORCE

Silt is not as cohesive as clay, but still needs proper water content for good compacting. The cohesive soils have the smallest particles of all soils. Silt particles are larger than in clay but they are still small enough to require high energy for deep compacting. A tamping rammer is the best choice for compacting silt.

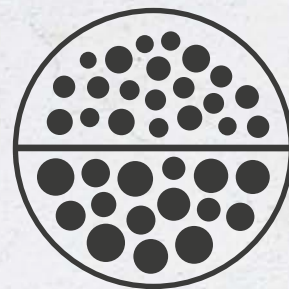

MACADAM – PUT ON THE PRESSURE

Cobbles and boulders need high compaction energy to achieve the necessary density and stability. It is especially important if the material is imbedded in clay or silt that may liquefy when wet. Layer thickness should be at least three times thicker than maximum particle size. Husqvarna LH 700 and LH 804 reversible plate compactors are ideal for large construction projects. The lighter Husqvarna LG 504 works well for smaller ones.



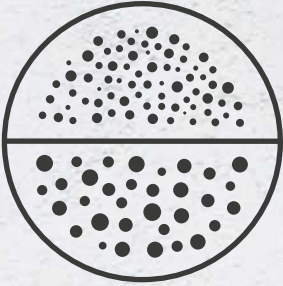

SAND AND GRAVEL – TAKE IT GENTLE

For sand and gravel you can achieve high-density compaction in either a dry or saturated state. The level of compaction depends more on grading than moisture. Too much compaction of sand and gravel is like beating a concrete wall with a sledgehammer. It can crush the material and reduce the load bearing capacity. Depending on the thickness of the layer, a lighter forward plate or heavier reversible plate compactor is recommended.

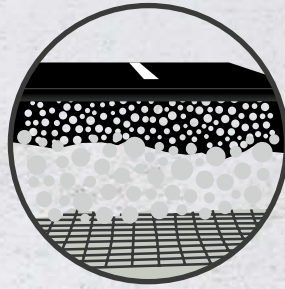

ASPHALT – LEAVE NO MARKS

Compaction has a profound influence on asphalt performance. Compaction transforms the asphalt mix from a loose state to a compact surface that carries heavy loads. Efficiency of compaction depends heavily on the internal resistance of asphalt. Machines must be able to compact without leaving marks and water helps to create a smooth surface. Here, an asphalt plate compactor or a duplex roller is a safe choice.





SOIL

FORWARD PLATES	LF 130 LT ¹		LF 100 L		LF 80 L	LF 75 L		LF 50 L
Engine	Honda GX160	Hatz 1B20	Honda GX160	Hatz 1B20	Honda GX160	Honda GX160	Honda GX160	Honda GX100
Power, kW	3.6	2.5	3.6	2.5	3.6	3.6	3.6	2.1
Fuel	Petrol	Diesel	Petrol	Diesel	Petrol	Petrol	Petrol	Petrol
Operating weight, kg	135	142	97	106	84	85	82	53
Frequency, Hz	95	95	95	95	95	95	95	95
Centrifugal force, kN	20	20	17	17	19	15	15	8
Speed, m/min	22	22	25	25	33	24	27	24
H/A vibrations, standard handle, m/s ²	5.4	6.8	6	9.3	6.7	6.0	6.0	6.9
H/A vibrations, vibr reduced handle, m/s ²	1.1	1.1	1.3	1.9	1.2	1.2	1.2	1.8
Sound power, guaranteed, dB(A)	104	104	104	105	103	104	104	100
Sound pressure at operators ear, dB(A)	95	93	93	93	91	91	91	89
Plate width, mm	500	500	500	500	420	500	420	320
Plate length, mm	580	580	595	595	570	570	570	505
L×W×H, mm	960×500×995	960×500×1,122	960×500×995	960×500×995	960×420×995	960×500×995	960×420×995	940×320×965
ARTICLE INFORMATION	967 89 66-01	967 89 69-01	967 85 51-01	967 85 51-03	967 85 50-01	967 89 67-02	967 89 67-01	967 85 47-01
RRP EXC VAT	£1,859.75	£2,875.26	£1,444.55	£2,430.65	£1,403.03	£1,380.54	£1,275.01	£1,027.62

1) With transport wheels.



TAMPERS	LT 800		LT 6005		LT 5005	
Engine	Hatz 1B20	Hatz 1B20	Honda GXR120	Honda GXR120	Honda GXR120	Honda GXR120
Power, kW	3.0	3.0	2.7	2.7	2.7	2.7
Fuel	Diesel	Diesel	Petrol	Petrol	Petrol	Petrol
Operating weight, kg	98	97	70	69	62	61
Frequency, Hz	12	12	12	12	12	12
Speed, m/min	12	12	15-18	15-18	15-18	15-18
H/A handle vibrations m/s ²	11.9	11.9	6.4	6.4	6.4	6.4
Sound power, guaranteed, dB(A)	107	107	106	106	106	106
Sound pressure at operators ear, dB(A)	95	95	92	92	92	92
Plate width, mm	330	280	280	230	230	150
Plate length, mm	332	332	332	332	332	332
L×W×H, mm	810×422×1,074	810×422×1,074	726×345×1,084	726×345×1,084	726×345×1,025	726×345×1,025
ARTICLE INFORMATION						
	967 89 70-02	967 89 70-01	967 85 45-02	967 85 45-01	967 85 46-01	967 85 46-02
RRP EXC VAT	£ 3,543.04	£ 3,543.04	£ 2,202.81	£ 2,130.15	£ 2,045.38	£ 1,960.61



ASPHALT AND SOIL

	LF 100 LAT ¹		LF 80 LAT ¹	LF 75 LAT ¹		LF 60 LAT ¹
Honda GX160	Hatz 1B20	Honda GX160	Honda GX160	Honda GX160	Honda GX160	Honda GX100
3.6	2.5	3.6	3.6	3.6	3.6	2.1
Petrol	Diesel	Petrol	Petrol	Petrol	Petrol	Petrol
109	118	95	97	95	95	67
95	95	95	95	95	95	95
17	17	19	15	15	15	10
25	25	33	24	27	25	25
6	9.3	6.7	6.0	6.0	6.0	7.9
1.3	1.9	1.2	1.2	1.2	1.2	1.9
104	105	103	104	104	104	100
93	93	91	91	91	91	88
500	500	420	500	420	420	350
595	595	570	570	570	570	545
960×500×995	960×500×995	960×420×995	1,037×500×995	960×420×995	960×420×995	986×350×968
967 85 51-02	967 89 68-01	967 85 50-02	967 85 49-02	967 85 49-01	967 85 48-01	
£ 1,709.24	£ 2,688.42	£ 1,603.71	£ 1,555.27	£ 1,399.57	£ 1,236.95	

ROUND PLATE	LX 90
Engine	Honda GX160
Power, kW	3.6
Fuel	Petrol
Operating weight, kg	96
Frequency, Hz	75
Centrifugal force, kN	16
Speed, m/min	22
H/A handle vibrations m/s ²	6.1
Sound power, guaranteed, dB(A)	104
Sound pressure at operators ear, dB(A)	92
Plate diameter, mm	450
L×W×H, mm	450×450×920
ARTICLE INFORMATION	
Manual start	967 89 71-01
RRP EXC VAT	£ 2,082.00



FORWARD AND REVERSIBLE PLATES	LH 804			LH 700		
Engine	Hatz 1D90V	Hatz 1D90V	Hatz 1D90V	Hatz 1D90V	Hatz 1D90V	Hatz 1D90V
Power, kW	11.0	11.0	11.0	11.0	11.0	11.0
Fuel	Diesel	Diesel	Diesel	Diesel	Diesel	Diesel
Operating weight, kg	873	856	820	841	824	788
Frequency, Hz	53	53	53	53	53	53
Centrifugal force, kN	95	95	95	95	95	95
Speed, m/min	30	30	30	30	30	30
H/A handle vibrations m/s ²	—	—	—	3.3	3.3	3.3
Sound power, guaranteed, LWA, dB(A)	109	109	109	109	109	109
Sound pressure at operators ear, LWA, dB(A)	—	—	—	98.4	98.4	98.4
Plate width, mm	960 (660+2×150)	810 (660+2×75)	660	960 (660+2×150)	810 (660+2×75)	660
L×W×H, mm	1,150×960×790	1,150×810×790	1,150×660×790	1,880×960×1,180	1,880×810×1,180	1,880×660×1,180
ARTICLE INFORMATION						
Manual start	—	—	—	—	—	—
Electric start	967 89 73-04	967 89 73-03	967 89 73-01	967 89 72-06	967 89 72-04	967 89 72-01
Electric start and compaction indicator	—	—	—	—	—	—
RRP EXC VAT	—	—	—	—	—	—
	£ 23,840.96	£ 22,341.74	£ 21,191.37	£ 18,732.96	£ 17,509.97	£ 15,813.93
	—	—	—	—	—	—



FORWARD AND REVERSIBLE PLATES	LG 300					
Engine	Honda GX270	Honda GX270	Hatz 1B30	Hatz 1B30	Hatz 1B30	Hatz 1B30
Power, kW	5.3	5.3	4.7	4.7	4.7	4.7
Fuel	Petrol	Petrol	Diesel	Diesel	Diesel	Diesel
Operating weight, kg	270	265	287	282	307	302
Frequency, Hz	68	68	68	68	68	68
Centrifugal force, kN	40	40	40	40	40	40
Speed, m/min	25	25	25	25	25	25
H/A handle vibrations m/s ²	2.4	2.4	1.7	1.7	1.7	1.7
Sound power, guaranteed, LWA, dB(A)	108	108	108	108	108	108
Sound pressure at operators ear, LWA, dB(A)	92	92	92	95	95	95
Plate width, mm	600	500	600	500	600	500
L×W×H, mm	1,385×600×1,120	1,385×500×1,120	1,385×600×1,120	1,385×500×1,120	1,385×600×1,120	1,385×500×1,120
ARTICLE INFORMATION						
Manual start	967 85 53-02	967 85 53-01	967 85 53-05	967 85 53-04	—	—
Electric start	—	—	—	—	967 85 53-06	967 85 53-07
RRP EXC VAT	—	—	—	—	—	—
	£ 4,999.70	£ 4,999.70	£ 7,203.72	£ 7,203.72	—	—
	—	—	—	—	£ 8,091.21	£ 8,091.21



LG 504			LG 400	
Hatz 1D81Z	Hatz 1D81Z	Hatz 1D81Z	Honda GX 390	Lombardini 15LD 440/S (Kohler)
9.2	9.2	9.2	8.3	6.2
Diesel	Diesel	Diesel	Petrol	Diesel
513	499	470	398	436
69	69	69	60	60
65	65	65	52	52
30	30	30	25	25
2.5	2.5	2.5	2.5	2.1
—	109	—	108	108
96	96	96	95	93
850 (550+2×150)	700 (550+2×75)	550	650	650
1,670×850×1,190	1,670×750×1,190	1,670×550×1,190	1,690×650×1,150	1,690×650×1,150
967 85 55-10	967 85 55-09	967 85 55-08	967 85 54-01	—
967 85 55-11	967 85 55-07	967 85 55-06	—	967 89 64-03
967 85 55-12	967 85 55-05	967 85 55-04	—	967 89 64-01
£ 9,762.40	£ 9,552.38	£ 9,016.24	£ 6,582.65	—
£ 10,378.37	£ 11,189.64	£ 11,006.26	—	£ 8,980.43
£ 11,874.87	£ 10,681.35	£ 11,048.29	—	£ 9,423.31



LG 204				LG 164				
Honda GX200	Hatz 1B20	Hatz 1B20	Hatz 1B20	Honda GX160	Honda GX160	Hatz 1B20	Hatz 1B20	Hatz 1B20
4.1	3.1	3.1	3.1	3.6	3.6	3.1	3.1	3.1
Petrol	Diesel	Diesel	Diesel	Petrol	Petrol	Diesel	Diesel	Diesel
211	228	251	244	157	148	185	170	166
65	65	65	65	80	80	80	80	80
36	36	36	36	28	28	28	28	28
23	22	22	22	22	22	22	22	22
3.5	2.8	2.8	3.4	2.3	2.3	2.8	3.5	3.2
106	108	108	108	108	108	108	108	108
84	93	93	85.1	82.4	81.9	93	84	84.1
500	500	600	500	450	350	600	450	350
1,334×500×1,126	1,334×500×1,126	1,334×600×1,126	1,334×500×1,126	119×450×1,069	119×350×1,069	119×600×1,069	119×450×1,069	119×350×1,069
967 85 52-01	967 85 52-05	—	—	967 85 56-01	967 85 56-02	967 89 76-04	967 89 76-02	967 89 76-01
—	—	967 85 52-03	967 85 52-06	—	—	—	—	—
£ 5,248.82	£ 6,181.29	—	—	£ 3,507.06	£ 3,507.06	£ 4,445.58	£ 4,254.07	£ 4,254.07
—	—	£ 6,895.78	£ 6,484.23	—	—	—	—	—



DOUBLE DRUM ROLLERS	LP 7505		LP 6505	
Engine	Hatz 1D50S	Hatz 1D50S	Hatz 1D42S	Hatz 1D42S
Power, kW	7.9	7.9	7.2	7.2
Fuel	Diesel	Diesel	Diesel	Diesel
Operating weight, kg	981	1,001	745	765
Frequency, Hz	57	57	58	58
Centrifugal force, kN	27	27	22	22
Speed, forward / reverse, km/h	0 - 3.6	0 - 3.6	0 - 3.6	0 - 3.6
H/A handle vibrations m/s ²	2.6	2.6	4.1	4.1
Sound power, guaranteed, dB(A)	107	107	107	107
Sound pressure at operators ear, dB(A)	88	88	88	88
Drum diameter, mm	400	400	400	400
Drum width, mm	750	750	650	650
L×W×H, mm	1,110 / 2,500×820×1,260	1,110 / 2,500×820×1,260	1,110 / 2,500×720×1,215	1,110 / 2,500×720×1,215
ARTICLE INFORMATION				
Manual start	967 89 74-01	—	967 85 57-02	—
Electric start	—	967 89 74-02	—	967 85 57-03
RRP EXC VAT	£ 14,817.45	—	£ 14,352.08	—
	—	£ 16,668.55	—	£ 15,279.36



Husqvarna LT 800.

ACCESSORIES AND SPARE PARTS		RRP	EXC VAT
■	Transport wheel kit	596 02 38-01	£ 125.00

Husqvarna LT 6005 and LT 5005.

ACCESSORIES AND SPARE PARTS		RRP	EXC VAT
■	Transport wheel kit	596 02 38-01	£ 125.00

Husqvarna LF 130 LT.

ACCESSORIES AND SPARE PARTS		RRP	EXC VAT
1	Block paving kit, width 500 mm	594 86 82-01	£ 115.00
3	Transport wheel kit	594 20 49-01	£ 134.00
4	Fork lift device	595 50 31-01	£ 29.00

Husqvarna LF 100 L and LF 100 LAT.

ACCESSORIES AND SPARE PARTS		RRP	EXC VAT
1	Block paving kit, width 500 mm	594 86 82-01	£ 115.00
2	Water tank, complete	595 12 08-01	£ 97.48
3	Transport wheel kit	594 20 49-01	£ 134.00
4	Fork lift device	595 50 31-01	£ 29.00

Husqvarna LF 80 L and LF 80 LAT.

ACCESSORIES AND SPARE PARTS		RRP	EXC VAT
1	Block paving kit, width 420 mm	594 86 81-01	£ 108.00
2	Water tank, complete	595 12 08-01	£ 97.48
3	Transport wheel kit	594 20 49-01	£ 134.00
4	Fork lift device	595 50 31-01	£ 29.00

Husqvarna LF 75 L and LF 75 LAT.

ACCESSORIES AND SPARE PARTS		RRP	EXC VAT
1	Block paving kit, width 500 mm	594 86 82-01	£ 115.00
1	Block paving kit, width 420 mm	594 86 81-01	£ 108.00
2	Water tank, complete	595 12 08-01	£ 97.48
3	Transport wheel kit	594 20 49-01	£ 134.00
4	Fork lift device	595 50 31-01	£ 29.00

Husqvarna LF 50 L.

ACCESSORIES AND SPARE PARTS		RRP	EXC VAT
1	Block paving kit, width 320 mm	594 75 72-01	£ 95.00
3	Transport wheel kit	595 12 07-01	£ 119.00

Husqvarna LF 60 LAT.

ACCESSORIES AND SPARE PARTS		RRP	EXC VAT
1	Block paving kit, width 350 mm	595 36 75-01	£ 102.00
2	Water tank, complete	594 21 26-01	£ 112.48
3	Transport wheel kit	595 12 07-01	£ 119.00

Husqvarna LH 804 and LH 700.

ACCESSORIES AND SPARE PARTS		RRP	EXC VAT
■	Extension plate kit 2×75 mm	594 82 60-01	£ 957.37
■	Extension plate kit 2×150 mm	594 82 61-01	£ 1,199.23

Husqvarna LG 504.

ACCESSORIES AND SPARE PARTS		RRP	EXC VAT
■	Extension plate kit 2×75 mm	594 75 87-01	£ 476.78
■	Extension plate kit 2×150 mm	594 75 88-01	£ 527.50
■	Block paving kit, width 700 mm	595 12 89-01	£ 419.00

Husqvarna LG 400.

ACCESSORIES AND SPARE PARTS		RRP	EXC VAT
■	Block paving kit, width 650 mm	594 44 79-02	£ 411.00

Husqvarna LG 300.

ACCESSORIES AND SPARE PARTS		RRP	EXC VAT
■	Block paving kit, width 600 mm	594 83 03-01	£ 334.00
■	Block paving kit, width 500 mm	594 83 02-01	£ 217.00
■	Transport device	594 83 05-01	£ 199.00

Husqvarna LG 204.

ACCESSORIES AND SPARE PARTS		RRP	EXC VAT
■	Block paving kit, width 600 mm	594 75 96-01	£ 217.00
■	Block paving kit, width 500 mm	594 82 58-01	£ 209.00
■	Transport device	594 83 05-01	£ 199.00

Husqvarna LG 164.

ACCESSORIES AND SPARE PARTS		RRP	EXC VAT
■	Block paving kit, width 600 mm	594 75 95-01	£ 202.00
■	Block paving kit, width 450 mm	594 83 01-01	£ 156.00
■	Block paving kit, width 350 mm	595 36 85-01	£ 145.00
■	Transport device	594 83 05-01	£ 199.00

Husqvarna LP 7505 and LP 6505.

ACCESSORIES AND SPARE PARTS		RRP	EXC VAT
■	Safety crank handle kit	594 17 09-01	£ 597.46

MANAGE THE CONCRETE JOB FROM START TO FINISH

Every construction project starts with a solid foundation. We provide you with the tools and solutions to create just that in concrete, delivering maximum productivity, performance and reliability. Our wide range of equipment for concrete placement and finishing covers vibrating, levelling and surfacing.

Range overview.

Husqvarna's range of concrete placement equipment includes both electric and petrol-powered vibrators, screeds and trowels, amounting to a total of 74 different models.



For more information, visit www.husqvarnacp.co.uk

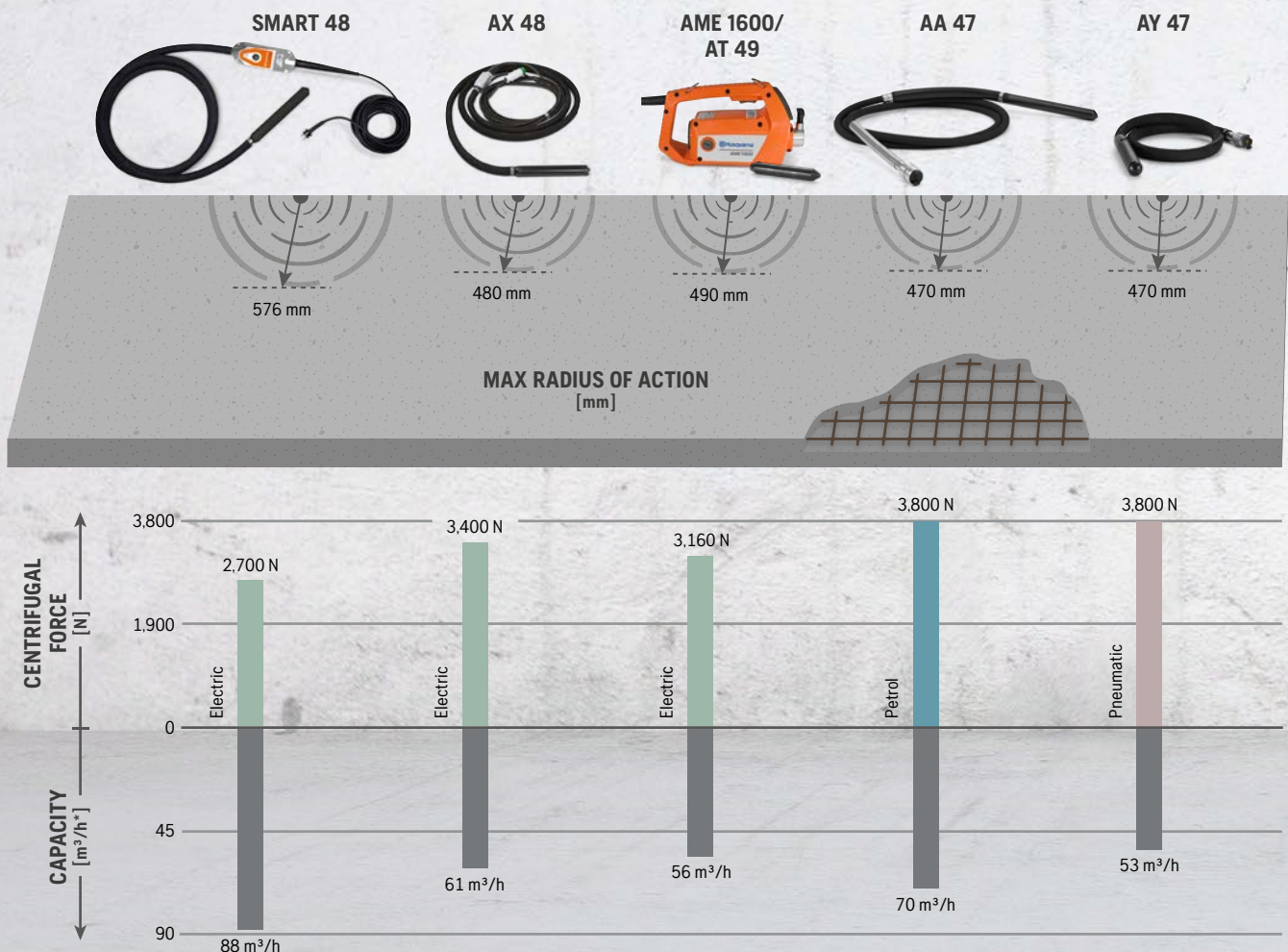

Vibrator capacity at slump S3.

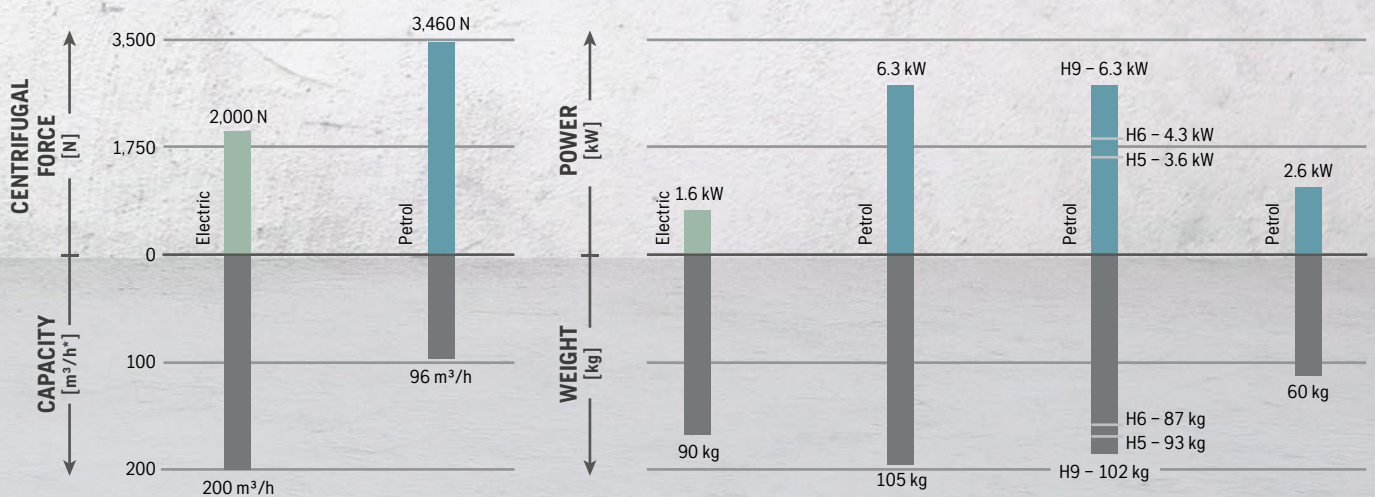
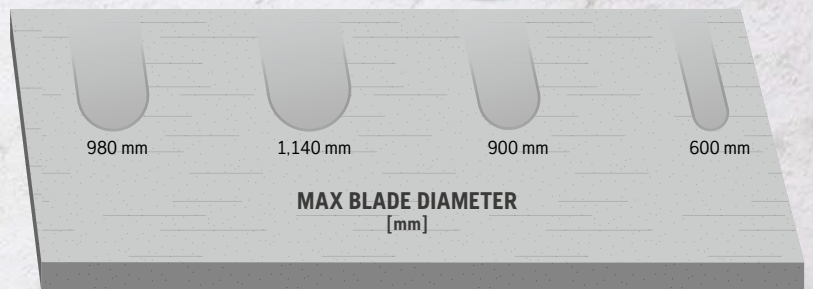
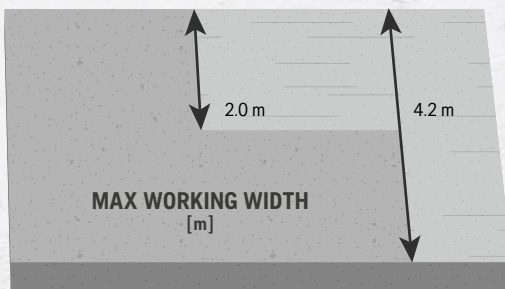

COVERING THE WHOLE JOB FROM PLACING TO FINISHING

Husqvarna offers a wide range of equipment for all process steps in the concrete placing and finishing process – including vibrating, levelling and surfacing of poured concrete surfaces and floors.

CONCRETE VIBRATION

Vibration helps remove the air voids from concrete as it is being poured or immediately afterwards. By removing the air, the density of the concrete increases, making the concrete stronger. Depending on the depth and slump of the concrete, a high density concrete can be achieved by using an internal vibrator or a vibrating screed.

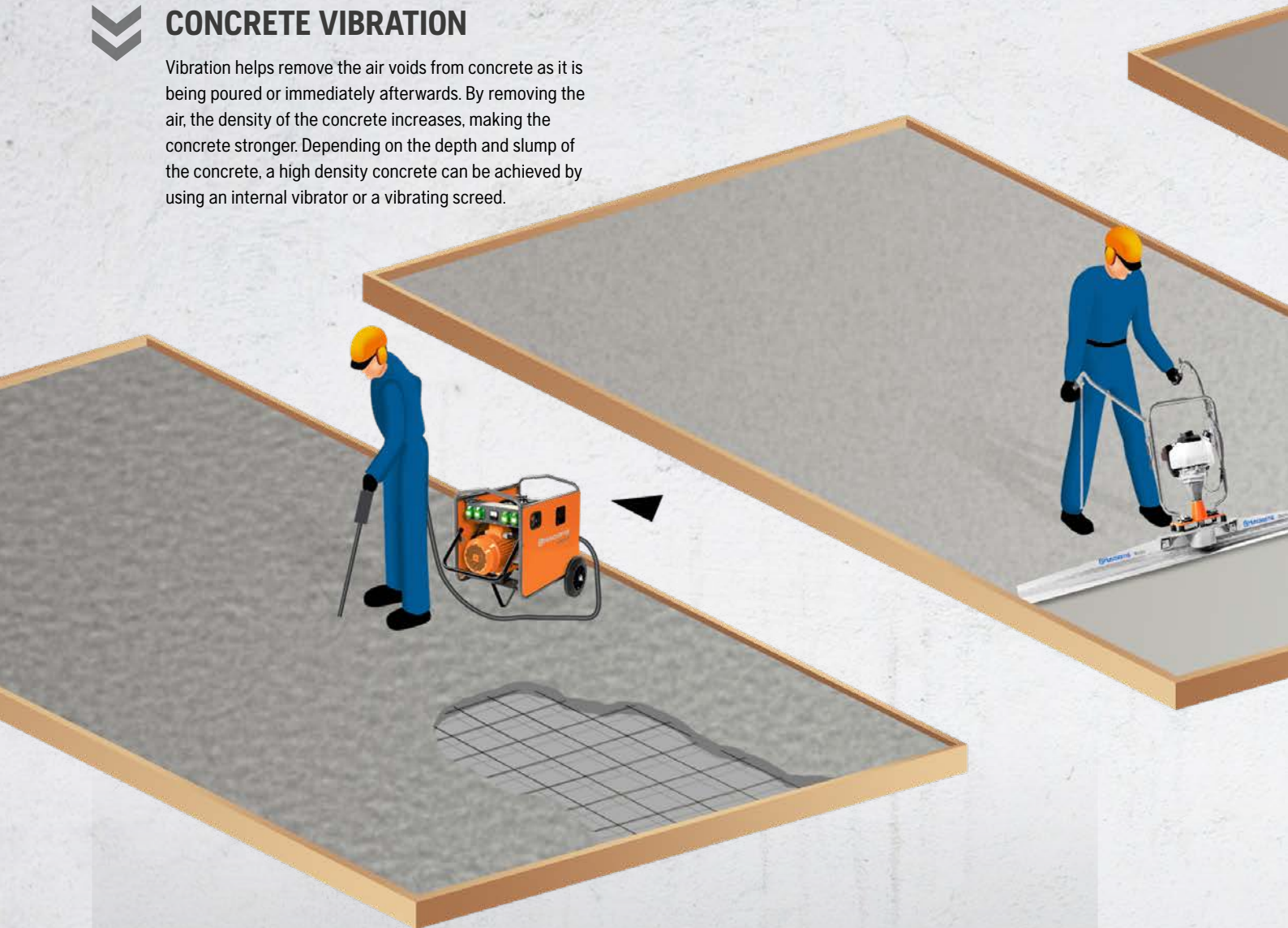

HOW TO CHOOSE THE BEST VIBRATOR FOR YOUR JOB

When choosing a vibrator, start by checking what power source you have access to – electricity, compressed air or no power at all. In the latter case, a petrol- or diesel-powered high-frequency electric vibrator is the most cost-efficient alternative.

The next consideration is the vibrator's hose length, tube size and radius of action for the vibrator. These variables are

determined by the size and depth of the pour, the distance between the rebar and the consistency of the concrete, which all are prescribed in the construction blueprints.

Naturally, the most productive combination of hose length, tube size and radius of action is the one that allows the operator to complete the work within the shortest time and lowest amount of dips.



CONCRETE SURFACING

Once the concrete reaches a plastic state, power trowels are used for floating and troweling to remove irregularities from the screeded surface. During this process, the concrete surface is compacted and sealed which makes the floor even more durable. The intention is to obtain a smoother and more even concrete floor, and also to reduce the concrete dust created from wear.



CONCRETE LEVELLING

In most cases, the concrete needs to be levelled to create an even surface. One or two screeding passes with a vibrating screed alone is often enough on single-reinforced slabs. If an already installed concrete floor is to be covered by a new concrete layer, surface vibration is an excellent method for obtaining a high level of adhesion between the two concrete constructions.



Husqvarna Smart series – high frequency electric vibrators.

SMART VIBRATORS	56	48	40
Tube diameter, mm	56	48	40
Frequency, vpm	12,000	12,000	12,000
Voltage, V	110	110	110
Frequency, Hz	50/60	50/60	50/60
Amperage, A	12.8	9	5
Hose length, m	5	5	5
Cable length, m	15	15	15
Sound power, LW dB(A)	94	91	86
Vibration value, m/s ²	2.47	5.87	4.62
ARTICLE INFORMATION			
	967 85 60-03	967 85 59-04	967 85 58-02
RRP EXC VAT	£ 1,468.94	£ 1,432.61	£ 1,396.28

SMART-E VIBRATORS	E 56	E 48	E 40
Tube diameter, mm	56	48	40
Frequency, vpm	12,000	12,000	12,000
Voltage, V	110	110	110
Frequency, Hz	50/60	50/60	50/60
Amperage, A	12.8	9	5
Hose length, m	0.5	0.5	0.5
Cable length, m	15	15	15
Total weight, kg	14.8	13.6	12
Sound power, LW dB(A)	94	91	86
Vibration value, m/s ²	0.52	0.52	0.52
ARTICLE INFORMATION			
	967 94 03-01	967 94 02-01	967 85 58-05
RRP EXC VAT	£ 1,689.28	£ 1,647.50	£ 1,605.73



AX VIBRATORS	AX 90	AX 65	AX 56 - 10 M	AX 56 - 8 M	AX 56 - 5 M	AX 48 - 10 M	AX 48 - 8 M	AX 48 - 5 M	AX 40	AX 36
Tube diameter, mm	90	65	56	56	56	48	48	48	40	38
Frequency, vpm	6,000	12,000	12,000	12,000	12,000	12,000	12,000	12,000	12,000	12,000
Voltage, V (3-phase)	42	42	42	42	42	42	42	42	42	42
Frequency, Hz	200	200	200	200	200	200	200	200	200	200
Amperage, A	21	19	11.7	11.7	11.7	10	10	10	4.5	6.2
Hose length, m	3	5	10	8	5	10	8	5	5	5
Cable length, m	10	10	10	10	10	10	10	10	10	10
Total weight, kg	26.6	18.8	20.5	18.5	16.1	17.4	15.4	15.1	13.2	13.1
Sound power, LW dB(A)	76	79	79	79	79	76	76	76	78	70
Vibration value, m/s ²	5.06	4.62	3.66	3.66	3.66	3.53	3.53	3.53	3.81	3.81
ARTICLE INFORMATION										
	967 94 00-01	967 85 83-01	967 85 82-03	967 85 82-02	967 85 82-01	967 85 81-03	967 85 81-02	967 85 81-01	967 85 80-01	967 85 79-01
RRP EXC VAT	£ 1,978.45	£ 994.40	£ 987.48	£ 923.13	£ 935.84	£ 923.82	£ 863.27	£ 890.84	£ 883.03	£ 909.61

VIBRASTAR	60	50	40
Tube diameter, mm	60	50	40
Frequency, vpm	12,000	12,000	12,000
Voltage, V (3-phase)	42	42	42
Frequency, Hz	200	200	200
Amperage, A	11	8	4
Hose length, m	5	5	5
Cable length, m	10	10	10
Total weight, kg	15	13	8.4
Sound power, LW dB(A)	84	76	75
Vibration value, m/s ²	3.23	3.28	1.8
ARTICLE INFORMATION			
	967 93 81-03	967 93 81-02	967 93 81-01
RRP EXC VAT	£ 585.95	£ 522.80	£ 484.80



AX Vibrator

Vibrastar

Husqvarna CF power units for AX/Vibrastar.

FREQUENCY CONVERTERS	CF 67T	CF 25	CF 11
Output power, kVA	4.7	1.8	0.8
Intensity at 42 V, A	67	25	11
Number of phases (primary voltage)	3	1 or 3	1
Number of outlets	4	2	1
Weight, kg	70	31	18
Protection index	IP55	IP55	IP55
Noise level, dB(A)	85	80	76
Transport wheels	standard	optional	—
ARTICLE INFORMATION			
230 V-1-50 Hz	—	967 93 87-01	967 93 79-01
400 V-3-50 Hz	967 93 82-01	967 91 34-02	—
400 V-3-50 Hz CI4P*	967 93 82-02	—	—
RRP EXC VAT			
230 V-1-50 Hz	—	£ 1,321.62	£ 1,279.54
400 V-3-50 Hz	£ 2,623.46	£ 1,184.15	—
400 V-3-50 Hz CI4P*	£ 3,471.72	—	—

* CI4P = Four outlets with motor breakers that protect the external vibrators against high ampere consumption.



GENERATORS	CFG 67	CFD 67	CFD 33	CFG 25
Engine type, 4-stroke & manual start	Honda GX 270	Lombardini 15 LD 350	Lombardini 15 LD 225	Honda GX 160
Fuel	Petrol	Diesel	Diesel	Petrol
Max power at 3,600 rpm, hp	8.4	7.5	4.8	4.8
Rated speed, rpm	3,000	3,000	3,000	3,000
Output rated power, kVA	4.7	4.6	2	1.8
Number of outlets	4	4	3	2
Rated amperage, A	67	65	33	25
Rated output voltage, V	42	42	42	42
Frequency, Hz	200	200	200	200
Weight, kg	85	95	68	45
Noise level (LW), dB(A)	97	108	105	94
Wheels	yes	yes	optional	optional
ARTICLE INFORMATION				
	967 92 84-01	967 92 85-01	967 92 83-01	967 92 82-01
RRP EXC VAT				
	£ 2,725.99	£ 2,763.98	£ 2,624.24	£ 2,076.61



DRIVE UNITS	AME 1600	AME 1600
Voltage, V (1-phase)	230	110
Frequency, Hz	50/60	50/60
Power, kW	1.6	1.6
Frequency, vpm	12,000	12,000
Weight, kg	6.1	6.1
Vibration value, m/s ²	4.16	4.16
Protection level	IP44	IP44
ARTICLE INFORMATION		
	967 93 33-01	968 93 36-01
RRP EXC VAT	£ 399.63	£ 399.63

FLEXIBLE SHAFTS SUPERFLEX	40	30	20	10
Length, m	4	3	2	1
Total weight, kg	7.3	5.6	3.8	2.4
ARTICLE INFORMATION				
	967 85 95-05	967 85 95-04	967 85 95-03	967 85 95-01
RRP EXC VAT	£ 186.84	£ 167.81	£ 152.24	£ 152.24



VIBRATOR HEADS	AT 59	AT 49	AT 39	AT 29
Tube diameter, mm	59	49	39	29
Frequency, vpm	12,000	12,000	12,000	12,000
Total weight, kg	3.9	2.7	2.1	1.3
ARTICLE INFORMATION				
	967 85 96-04	967 85 96-03	967 85 96-02	967 85 96-01
RRP EXC VAT	£ 273.34	£ 240.47	£ 237.01	£ 228.36

Husqvarna AA and AZ series – mechanical vibrators.



MECHANICAL VIBRATORS (PENDULUM TYPE)	AA VIBRATORS					AZ VIBRATORS			
	AA 77	AA 67	AA 47	AA 37	AA 27	AZ 56	AZ 46	AZ 36	AZ 26
Tube diameter, mm	75	63	50	39	25	55	45	35	25
Frequency, vpm	9,200	10,500	11,200	12,000	12,000	12,000	12,000	12,000	12,000
Hose length, m	6	6	6	6	6	4.8	4.8	4.8	4.8
Total weight, kg	29	25	23	19	10	17	16	11.6	9.5
Sound power, LW dB(A)	75.7	75.8	73	68	69	90.0	87.4	82.0	77.5
Vibration value, m/s ²	3.16	2.66	3.52	1.56	2.46	8.27	2.42	5.22	2.00
ARTICLE INFORMATION									
Standard coupling	967 85 77-01	967 85 76-01	967 85 75-01	967 85 74-01	967 85 73-01	967 93 91-01	967 93 80-01	967 93 90-01	967 93 89-01
RRP EXC VAT	£ 854.62	£ 693.73	£ 583.01	£ 525.92	£ 477.48	£ 326.97	£ 301.02	£ 264.69	£ 264.69

Husqvarna AM drive units for AA and AZ vibrators.



DRIVE UNITS	AMG 3200	AMD 3000
Fuel	Petrol	Diesel
Power, hp	4.8	4.1
Speed, rpm	2,900	2,900
Weight, kg	15	46
Engine brand	Honda	Lombardini
Sound power, LW dB(A)	103.8	79
ARTICLE INFORMATION		
Standard coupling	967 85 72-01	967 92 86-01
RRP EXC VAT	£ 773.31	£ 1,924.66

Husqvarna AY series – pneumatic vibrators.



PNEUMATIC POKER	AY 157	AY 107	AY 87	AY 77	AY 67	AY 57	AY 47	AY 37	AY 27
Tube diameter, mm	155	108	87	77	67	56	47	36	26
Air consumption, m ³ /min	2.7	1.9	1.6	1.3	1	1	0.7	0.46	0.36
Frequency, vpm	12,000	15,000	15,900	16,000	17,500	18,000	18,000	19,000	21,000
Hose length, m	0.8	1.5	1.5	2	2	2	2	2	2
Total weight, kg	28	23	18	17	11	10	7	5	4
Sound power, LW dB(A)	92.4	96.3	94.0	98	94	95	95.8	89.2	84.5
Vibration value, m/s ²	12.29	2.91	1.95	2.38	2.10	2.13	2.39	1.02	0.51
ARTICLE INFORMATION									
1.5 m hose	967 87 99-01	967 93 99-01	967 93 98-01	—	—	—	—	—	—
2 m hose	—	—	—	967 93 97-01	967 93 96-01	967 93 95-01	967 93 94-01	967 93 93-01	967 93 92-01
4 m hose	—	—	—	967 93 97-02	967 93 96-02	967 93 95-02	967 93 94-02	967 93 93-02	967 93 92-02
RRP EXC VAT	£ 3,995.00	£ 1,299.23	£ 951.50	—	—	—	—	—	—
1.5 M HOSE	£ 3,995.00	£ 1,299.23	£ 951.50	—	—	—	—	—	—
2 M HOSE	—	—	—	£ 536.30	£ 482.67	£ 434.23	£ 425.58	£ 416.93	£ 404.82
4 M HOSE	—	—	—	£ 695.46	£ 647.02	£ 593.39	£ 583.01	£ 551.87	£ 546.68

Husqvarna BV series – concrete leveling – walk-behind screeds.



WALK-BEHIND SCREEDS	BV 20 H	BV 20 E	BV 20 G
Working width, m	2.0	2.0	2.0
Weight operating, kg	7.5	19.8	16.6
Length handle, m	1.8 + 1.8	1.8 + 1.8	1.8 + 1.8
Energy	Manual	Electric	Petrol
Motor/engine	—	230 V-1-50/60 Hz	4-stroke Honda GX 25
Power, kW	—	0.27	0.72 at 7,000 rpm
Vibration frequency, rpm	—	2,000-10,000	4,000-7,000
Centrifugal force, N	—	2,000	1,100
Vibration value, m/s ²	—	3.2	3.2
Noise level, dB(A)	—	91	91
ARTICLE INFORMATION			
	967 85 61-01	967 92 87-01	967 85 62-01
Extension handle	595 02 95-01	595 02 95-01	595 02 95-01
RRP EXC VAT	£ 461.91	£ 1,797.47	£ 1,185.05
EXTENSION HANDLE	£ 33.00	£ 33.00	£ 33.00



WALK-BEHIND SCREED	BV 30
Weight, drive unit, kg	14
Vibrating unit*	4-stroke Honda GX35
Power, kW	1.6 at 7,000 rpm
Vibration frequency, rpm	2,000-7,400
Centrifugal force, N	3,460
Vibration value, m/s ²	3.25
Noise level, dB(A)	108
ARTICLE INFORMATION	
Without blade	967 85 63-01
RRP EXC VAT	£ 1,557.00

* The drive unit is delivered without screed blades (ordered separately).

BV 30 SCREED BLADE	1.8 M	2.4 M	3.0 M	3.6 M	4.2 M
Working width, m	1.8	2.4	3.0	3.6	4.2
Weight, kg	6.5	8	9.6	11.2	12.8
ARTICLE INFORMATION					
	967 85 87-01	967 85 88-01	967 85 89-01	967 85 90-01	967 85 91-01
RRP EXC VAT	£ 228.88	£ 289.43	£ 382.68	£ 434.75	£ 498.93

Husqvarna modular screeds.



MODULAR SCREEDS	BT 90 E	BT 90 G	BT 90 P
Engine	Electric motor 3-phase	Honda GX270	Air Compressor
Voltage, V-Hz	400 V-3-50 Hz	—	—
Power, kW	3	5 at 2,900 r.p.m.	—
Full load current, A	6.15	—	—
Speed, r.p.m.	2,865	2,900	—
Maximum screed length, m	20	20	25
Working pressure, bar	—	—	3-6
Air consumption per screed, m ³ /min	—	—	0.26
Sound Pressure Lpa dB(A)	89	89	—
Sound Power Lw dB(A)	100	100	—
Weight, kg (including free end - 18 kg)	96	93	40
ARTICLE INFORMATION			
	967 94 11-02	967 94 11-03	967 94 11-08
RRP EXC VAT	£ 4,423.60	£ 4,201.67	£ 3,085.63

SCREED SECTION	0.5 M ELECTRIC/PETROL	0.75 M ELECTRIC/PETROL	1 M ELECTRIC/PETROL	2 M ELECTRIC/PETROL	3 M ELECTRIC/PETROL	1 METER PNEUMATIC	2 METER PNEUMATIC	3 METER PNEUMATIC
Height, mm	376	376	376	376	376	376	376	376
Working length, mm	500	750	1,000	2,000	3,000	1,000	2,000	3,000
Total width, mm	420	420	420	420	420	420	420	420
Weight, kg	24	28	32	57	82	32	58	83
ARTICLE INFORMATION								
	967 94 11-04	967 94 11-16	967 94 11-05	967 94 11-06	967 94 11-07	967 94 11-09	967 94 11-10	967 94 11-11
RRP EXC VAT	£ 548.58	£ 850.12	£ 890.73	£ 1,259.28	£ 1,480.88	£ 892.51	£ 1,208.58	£ 1,455.32



MODULAR SCREEDS	SVE ELECTRIC	SVG PETROL
Engine	A.C motor	Honda GX 160
Voltage, V	400V-3-50Hz	—
Power, kW	2.2	4.1
Full load current, A	4.7	—
Speed, r.p.m.	2,850	3,200
Maximum screed length, m	25	25
Sound Pressure Lpa dB(A)	89	89
Sound Power Lw dB(A)	96	98
Weight, kg (including free end - 17 kg)	80	76
ARTICLE INFORMATION		
	967 95 57-01	967 95 58-01
RRP EXC VAT	£ 2,298.80	£ 1,689.94

SCREED SECTION	0.5 M , SVE/SVG	0.75 M, SVE/SVG	1 M, SVE/SVG	2 M, SVE/SVG	3 M, SVE/SVG
Height, mm	515	515	515	515	—
Working length, mm	500	750	997	1,998	2,998
Total width, mm	380	380	380	380	380
Total weight, kg	19.4	20	21.2	38.4	55.4
ARTICLE INFORMATION					
	967 95 59-01	967 95 59-02	967 95 59-03	967 95 59-04	967 95 59-05
RRP EXC VAT	£ 562.62	£ 582.84	£ 618.20	£ 1,046.92	£ 1,366.21

Husqvarna double beam screeds.



DOUBLE BEAMS	BE 20	BE 30
Drive model	ER355	HONDA GX120 UT1 SXS4 SD – 4 stroke
Voltage, V-Hz	400 V–3–50 Hz	—
Power, kW	0.45	2.6 for 3,600 rpm
Current, A	0.8	—
Speed, r.p.m.	3,000	3,600
Direction of rotation	Both	Counterclockwise
Tank capacity, l	—	2
Starting	Phase inverter switch	Recoil Starter
Sound Pressure Lpa dB(A)	—	75.7
Sound Power Lw dB(A)	94	103.8
Total weight, kg	37	32
ARTICLE INFORMATION		
	967 95 64–01	967 94 12–02
RRP EXC VAT	£ 1,548.87	£ 2,178.59

DOUBLE BEAMS	BD 32	BD 42	BD 52	BD 62
Height, mm	100	100	100	100
Length, m	3.2	4.2	5.2	6.2
Width, mm	400	400	400	400
Total weight, kg	32	41	47	57
ARTICLE INFORMATION				
	967 95 60–01	967 95 61–01	967 95 62–01	967 95 63–01
	£ 1,023.30	£ 1,537.97	£ 1,707.51	£ 1,883.11

Husqvarna BG series – concrete surfacing / walk-behind trowels.



POWER TROWELS	BG 475	BG 375	BG 275	BG 175	BG 125	BG 75
Model code	H9 L BC TP	H9 L BC TP	H6 L BC TP	H5 F BC TP	H4 F BC TP	E F TP
Protection ring (∅), mm	1,200	950	950	950	615	615
Operating weight, kg	105	102	93	87	60	60
Blade diameter, mm	1,140	900	900	900	600	600
Disc diameter, mm	—	945	945	945	610	610
Floating blade (∅), mm	1L160	945	945	945	—	—
Blade speed, rpm	40–115	40–115	40–115	40–115	40–115	120
Number of blades	4	4	4	4	4	4
Type of handle	Long Foldable	Long Foldable	Long Foldable	Foldable Vibro-reduced	Short foldable	Short foldable
Clutch type	Belt Clutch	Belt Clutch	Belt Clutch	Belt Clutch	Belt Clutch	—
Blade arm type	Bolt-on	Quick Release/Bolt-on	Quick Release/Bolt-on	Quick Release/Bolt-on	Bolt-on	Bolt-on
Honda engine	GX270	GX270	GX200	GX160	GX120	—
Power, kW (hp) @ 3.600 rpm	6.3 (8.4)	6.3 (8.4)	4.3 (5.8)	3.6 (4.8)	2.6 (3.5)	1.5 (input)
Voltage	—	—	—	—	—	230 V–1–50 Hz
Fuel	Petrol	Petrol	Petrol	Petrol	Petrol	Electric
Fuel tank capacity, l	5.3	5.3	3.1	3.1	2.5	—
Vibration value, m/s ²	3.5	3.5	3.5	3.5	6.2	3.7
Sound power level, guaranteed, LWa dB(A)	106	106	106	106	100	104
Sound pressure level at operator's position, LpA dB(A)	92	92	92	92	84	86
ARTICLE INFORMATION						
	967 92 92–01	967 92 91–01	967 92 90–01	967 92 89–01	967 92 88–01	967 92 93–01
RRP EXC VAT	£ 3,498.58	£ 2,965.74	£ 2,239.14	£ 2,118.04	£ 1,996.94	£ 2,508.70



COMBI TROWELS	BG COMBI 1020	BG COMBI 850
Model code	E-L-TP	E-L-TP
Protection ring (∅), mm	1,020	850
Operating weight, kg	88	86
Blade diameter, mm	850/915/980	850/915/980
Disc (∅), mm	865/965/1,015	865/965/1,015
Blade speed, rpm	60/120	60/120
Number of blades	4	4
Type of handle	Long	Long
Pitch control	Twist-Pitch	Twist-Pitch
Lifting hook	Standard	Standard
Transport wheels	Standard	Standard
Blade arm type	Quick Release	Quick Release
Engine	400V-3-50/60 Hz	400V-3-50/60 Hz
Input power. Low/high speed, kW	1.6/2.4	1.6/2.4
Vibration value, m/s ²	1.4	1.4
Sound power, guaranteed, LWA dB(A)	94	94
Sound pressure at operators ear, LpA dB(A)	77	77
ARTICLE INFORMATION		
	967 92 95-01	967 92 94-01
RRP EXC VAT	£ 3,623.18	£ 4,192.40

Husqvarna 42 V-3-200 HZ pokers (AX and Vibrastar).

ACCESSORIES		RRP EXC VAT
Extension cable, 5 m	596 57 02-01	£ 132.29
Extension cable, 10 m	596 57 02-02	£ 113.57
Extension cable, 15 m	596 57 02-03	£ 186.87
Extension cable, 20 m	596 57 02-04	£ 333.05

Husqvarna Smart and AX pokers.

ACCESSORIES		RRP EXC VAT
Elastomer end cap ∅ 36	594 78 61-01	£ 117.13
Elastomer end cap ∅ 40	595 15 67-01	£ 98.46
Elastomer end cap ∅ 48	595 15 68-01	£ 80.55
Elastomer end cap ∅ 56	595 02 96-01	£ 139.52

Husqvarna CFG/CFD/CF trolleys.

ACCESSORIES		RRP EXC VAT
Transport trolley CFG 25	594 86 24-01	£ 159.00
Transport trolley CFD 33	596 86 41-01	£ 169.00
Transport trolley CF	596 40 80-01	£ POA

Husqvarna BT 90.

ACCESSORIES		RRP EXC VAT
0.5 m extension	594 86 05-02	£ POA
Outriggers	594 86 06-01	£ POA
Crown Invert bracket (Electric and petrol version)	596 86 42-01	£ POA
Skate BT 90	595 49 91-03	£ POA

Husqvarna BD.

ACCESSORIES		RRP EXC VAT
Outtrigger	596 19 24-01	£ POA
Skate (cpl set for BD 32 - BD 62)	594 70 98-02	£ POA

Husqvarna SVE/SVG.

ACCESSORIES		RRP EXC VAT
0.5 m extension	596 19 25-01	£ POA
Outtrigger, standard	596 75 53-01	£ POA
Outtrigger, with lifting device	596 75 54-01	£ POA
Double electrical winch kit	594 71 09-01	£ POA
Skates (one piece)	594 70 98-01	£ POA
Third man winch	596 86 44-01	£ POA

Husqvarna BG 375.

ACCESSORIES		RRP EXC VAT
Wheel kit	594 75 15-01	£ 164.88

Husqvarna BG 245.

ACCESSORIES		RRP EXC VAT
Wheel kit	596 19 23-01	£ 63.00

Husqvarna BG.

ACCESSORIES		RRP EXC VAT
Wheel kit BG 475/479	594 75 15-01	£ 164.88
Wheel kit BG 375	594 75 15-01	£ 164.88
Wheel kit BG 245/244	596 19 23-01	£ 63.00
Spare ring BG COMBI ∅ 850 mm	967 93 49-02	£ POA
Spare ring BG COMBI ∅ 1020 mm	596 47 47-01	£ POA



POWER TROWEL BLADES AND FLOAT DISCS FOR CONCRETE FINISHING

To provide you with the best performance, Husqvarna offers a wide range of blades and discs, suitable for achieving unmatched performance at the final stage of the process. In our two ranges – ProLine and ClassicLine – you can easily find the suitable performance level to match your job.

STEEL FLOAT BLADE. Float blades are used for floating the concrete surface in the initial stage of the concrete finishing process. Husqvarna float blades have a nearly flat surface, creating suction between the blade and the surface. This moves the concrete from a higher position to a lower position on the slab.

STEEL FLOAT DISC. Float discs are an alternative to float blades. Float discs increase the overall flatness of the concrete slab.

STEEL FINISH BLADE. Finish blades are used after the floating process is complete and the surface has hardened or dried. The excellent quality of the blades offers the operator great advantage to adjust the angle of the blades to achieve the desired finishing.

PLASTIC FINISH BLADE. In some cases, finishing with steel blades leaves dark shade marks on the concrete surface, especially on light reflective or coloured surfaces, due to metal deposits. The high quality plastic blades (ultra-high molecular weight polyethylene) offers contractors a perfect finish to their coloured slabs.

COMBINATION BLADE. Combination blades are a two-in-one blade option. The shape of the blade allows one side to be used for floating and the other side for finishing. The combination blades offer operators a choice to complete both floating and finish operation without switching between two different blade options.

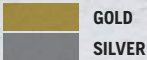

See page 16 for more information.

APPLICATION GUIDE	PROLINE					CLASSICLINE			
	STEEL FLOAT BLADE	STEEL FLOAT DISC	STEEL FINISH BLADE	PLASTIC FINISH BLADE	COMBINATION BLADE	STEEL FLOAT BLADE	STEEL FLOAT DISC	STEEL FINISH BLADE	COMBINATION BLADE
Floating	●●●	●●●	—	—	●●	●●●	●●●	—	●●
Rough trowelling	●	—	●●●	—	●●	●	—	●●●	●●
Smooth trowelling	—	—	●●●	●●●	●	—	—	●●●	●

●●● = Optimal ●● = Good ● = Acceptable — = Not recommended

Husqvarna ProLine.

- High thickness
- Quick release attachment (BG 375 and BG Combi)
- Special inclusion: Plastic Blades

Husqvarna ProLine offers gold level high-quality plastic blades, steel blades and steel discs with long life and high wear resistance for optimal performance. It consists of the Float blade, Float disc, Finish blade and Combination blade options. In addition, we offer a quick release option that saves time for high productive professionals, by reducing the time used to change the blades.

Husqvarna ClassicLine.

- Medium thickness
- Standard bolt-on attachment

Husqvarna ClassicLine offers silver level quality steel blades and discs with excellent performance for all concrete jobs. ClassicLine consists of the Float disc, Finish blade and Combination blade options.

Trowel blades and floating discs.

	PRODUCT NUMBER	TYPE	MATERIAL	THICKNESS, MM	DIAMETER, MM	WIDTH, MM	LENGTH, MM	PCS/PACK	RRP EXC VAT
BG 475 – PRO LINE									
Floating blades	594 20 78-01	Bolt-On	Steel	3		247	467	4	£ 39.00
Finishing blades	594 86 71-01	Bolt-On	Steel	1.6		150	460	4	£ 69.00
Combination blades	594 86 70-01	Bolt-On	Steel	1.6		200	458	4	£ 75.00
Finishing blades	594 86 74-01	Bolt-On		10		150	458	4	£ 89.00
BG 475 – CLASSIC LINE									
Finishing blades	594 19 86-01	Bolt-On	Steel	1.5		153	459	4	£ 59.00
BG 375 – PRO LINE									
Floating disc	594 24 36-01	Slide-On Finishing Blades	Steel	3	950			1	£ 129.00
Floating blades	594 19 83-01	Quick-Release	Steel	3		218	358	4	£ 89.00
Finishing blades	594 22 76-01	Quick-Release	Steel	1.6		153	376	4	£ 65.00
Combination blades	594 86 69-01	Bolt-On	Steel	1.6		200	337	4	£ 75.00
Finishing blades	594 86 73-01	Bolt-On	Plastic	10		153	376	4	£ 109.00
BG 375 – CLASSIC LINE									
Floating disc	594 24 02-01	Slide-On Finishing Blades	Steel	2.5	950			1	£ 119.00
Finishing blades	594 71 11-01	Bolt-On	Steel	1.6		152	355	4	£ 39.00
Combination blades	594 86 68-01	Bolt-On	Steel	1.6		200	337	4	£ 65.00
BG 245 – PRO LINE									
Floating disc	594 24 40-01	Slide-On Finishing Blades	Steel	2.5	608			1	£ 95.00
Combination blades	594 70 99-01	Bolt-On	Steel	1.6		127	235	4	£ 55.00
Finishing blades	594 86 72-01	Bolt-On	Plastic	10		125	227	4	£ 63.00
BG 245 – CLASSIC LINE									
Floating disc	595 07 12-01	Slide-On Finishing Blades	Steel	2	610			1	£ 79.00
Combination blades	594 86 67-01	Bolt-On	Steel	1.5		127	235	4	£ 50.00
BG COMBI – PRO LINE									
Floating blades	594 19 83-01	Quick-Release	Steel	3		218	358	4	£ 89.00
Finishing blades	594 22 76-01	Quick-Release	Steel	1.6		153	376	4	£ 65.00
Combination blades	594 86 69-01	Bolt-On	Steel	1.6		200	337	4	£ 75.00
Finishing blades	594 86 73-01	Bolt-On	Plastic	10		153	376	4	£ 109.00
BG COMBI – CLASSIC LINE									
Floating disc	594 24 10-01	Slide-On Finishing Blades	Steel	2.5	865			1	£ 149.00
Floating disc	594 24 36-01	Slide-On Finishing Blades	Steel	3	950			1	£ 129.00
Floating disc	594 24 12-01	Slide-On Finishing Blades	Steel	2.5	1015			1	£ 139.00

CUT ULTRA-EARLY FOR STRAIGHT LINES- DON'T WAIT FOR RANDOM CRACKS

Husqvarna Soff-Cut® is an ideal system for ultra-early sawing of contraction joints after pouring concrete slabs. It's a solution for minimising the risk of random cracking, which is one of the most costly and aggravating problems faced by a concrete contractor. The main benefits are the high production rates combined with the possibility to pour and cut the same day, and of course, the tidy end result achieved by only shallow cutting depths.

Range overview.

Husqvarna Soff-Cut range includes four models with cutting depth from 30 mm to 76 mm powered by engines from 3.3 kW to 17.2 kW, weighing from 39 kg to 221 kg. For optimal production rate, choose the Soff-Cut model suitable for your kind of operation.

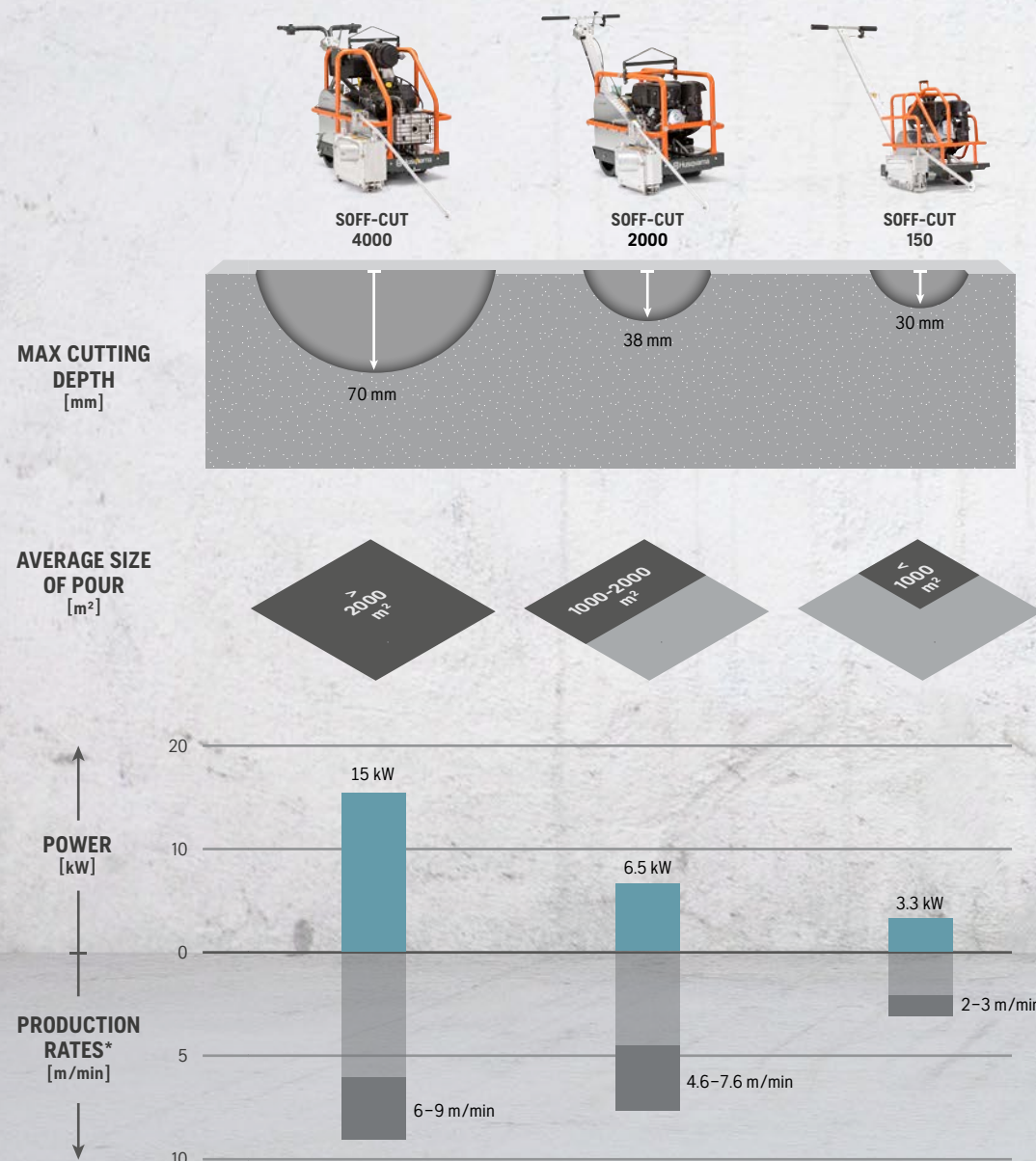

*PRODUCTION RATES

Please note that the production rates are rough averages and may vary due to for example: depth of cut, proper blade selection or cutting in the green zone.



The problem.

As concrete hydrates and begins to set, it develops internal stresses. The objective in controlling shrinkage cracking is to relieve these stresses before they seek their own relief in the form of a random crack.

The solution.

With the Husqvarna Soff-Cut Ultra Early Entry™ dry-cutting system, joints are sawn in the green zone—within the first hour or two after finishing. The Husqvarna Soff-Cut technology is based on the combination of the Soff-Cut blade and skid plate. The up-cutting rotation of the blade combines with the skid plate, which applies pressure to the surface to prevent chipping and spalling. Soff-Cut allows you to cut in the green zone as part of the finishing process, to effectively control shrinkage cracking.



Random cracking is amongst the most costly and aggravating problems facing concrete contractors.

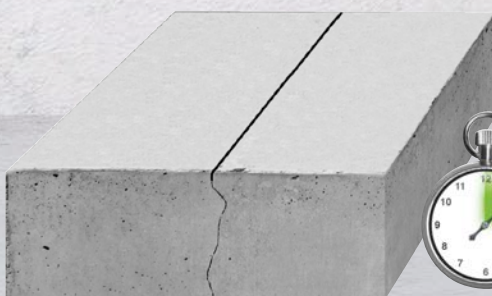

Soff-Cut has the Ultra Early Entry™ dry-cutting system which controls random cracking by making the cut at an early stage.

For more information, visit www.husqvarnacp.co.uk

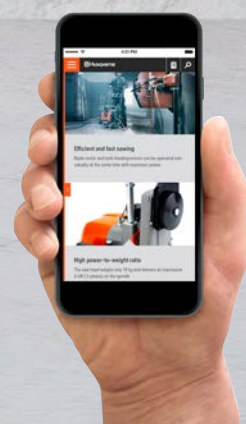



ULTRA EARLY ENTRY™ SAW*	SOFF-CUT 4000	SOFF-CUT 2000	SOFF-CUT 150
TECHNICAL SPECIFICATIONS			
Engine manufacturer	Kohler	Kohler	Kohler
Max power, kW**	14.9	6.5	4.0
Max blade diameter, mm	350	250	150
Max depth of cut, mm	70	38	30
Weight, kg	191	144	40
CE certified	Yes	Yes	Yes
ARTICLE INFORMATION			
	966 84 55-06	966 84 53-04	966 84 48-16
RRP EXC VAT	£ 13,490.12	£ 11,755.88	£ 2,563.89

* With VAC port. ** As rated by the engine manufacturer.

Husqvarna Soff-Cut 4000.

ACCESSORIES		RRP EXC VAT
Headlight kit	505 48 47-02	£ 142.08
Non-VAC rebuild kit	595 95 05-01	£ 595.00
SPARE PARTS		RRP EXC VAT
Air filter, 2 pieces	505 48 23-06	£ 117.40
Blade belt	505 48 39-02	£ 38.77
Blade wrench	505 48 31-03	£ 7.50
Pump belt	505 48 48-01	£ 29.50

Husqvarna Soff-Cut 2000.

ACCESSORIES		RRP EXC VAT
Headlight kit	505 48 47-01	£ 201.09
Non-VAC rebuild kit	595 90 93-01	£ 577.65
SPARE PARTS		RRP EXC VAT
Air filter	505 48 23-02	£ 53.00
Blade belt	505 48 22-02	£ 36.00
Blade wrench	505 48 31-03	£ 7.50
Pump belt	505 48 40-02	£ 18.00

Husqvarna Soff-Cut 150.

ACCESSORIES		RRP EXC VAT
Vac attachment cover	589 94 90-01	£ 66.00
SPARE PARTS		RRP EXC VAT
Air filter	505 48 23-01	£ 73.43
Blade belt, 2 pieces	505 48 22-01	£ 12.95
Blade wrench	505 48 31-02	£ 5.75



Headlight kit

GOLD

See page 16 for more information.



XL14



XL10



XL6

PRODUCT	XL14			XL10			XL6		
	2000	3000	5000	2000	3000	5000	2000	3000	5000
MATERIAL									
Very hard to hard aggregate concrete	●●●	—	—	●●●	—	—	●●●	—	—
Hard to medium-hard aggregate concrete	—	●●●	—	—	●●●	—	—	●●●	—
Soft to very soft aggregate concrete	—	—	●●●	—	—	●●●	—	—	●●●
RECOMMENDED EQUIPMENT	SC 4200, SC 4000			SC 2000e			SC 150		

●●● = Optimal ●● = Good ● = Acceptable — = Not recommended

Husqvarna XL14/XL10/XL6.

PRODUCT NUMBER	NAME	DIAMETER, MM	SEGMENT SHAPE	SEGMENT LENGTH, MM	SEGMENT THICKNESS, MM	SEGMENT HEIGHT, MM	NUMBER OF SEGMENTS	BORE	RRP EXC VAT
XL14									
542 75 61-13	XL14-2000	350	Flat	40	3.2	9+2.5	24	Soff-Cut Triangular	£ 529.16
542 75 61-14	XL14-3000	350	Flat	40	3.2	9+2.5	24	Soff-Cut Triangular	£ 529.16
542 75 61-16	XL14-5000	350	Flat	40	3.2	9+2.5	24	Soff-Cut Triangular	£ 529.16
XL10									
542 75 61-01	XL10-2000	250	Flat	40	2.6	9+2.5	17	Soff-Cut Triangular	£ 349.78
542 75 61-02	XL10-3000	250	Flat	40	2.6	9+2.5	17	Soff-Cut Triangular	£ 349.78
542 75 61-04	XL10-5000	250	Flat	40	2.6	9+2.5	17	Soff-Cut Triangular	£ 349.78
XL6									
542 77 70-06	XL6-2000	150	Flat	32	2.6	8+1.5	12	Soff-Cut Triangular	£ 123.32
542 77 70-07	XL6-3000	150	Flat	32	2.6	8+1.5	12	Soff-Cut Triangular	£ 123.32
542 77 70-09	XL6-5000	150	Flat	32	2.6	8+1.5	12	Soff-Cut Triangular	£ 123.32

Additional blades on request.



Use Soff-Cut joint protectors at saw-cut intersections prior to cross-cutting in order to prevent the corners from breaking down



A Soff-Cut anti-ravel skid plate comes with every XL blade. This allows for same-day sawing without chipping and spalling.

JOINT PROTECTORS	RRP EXC VAT
Blue, 150 pieces-300 and 350 mm blades	505 48 32-03 £ 14.40
Red, 150 pieces-150, 200 and 250 mm blades	505 48 32-02 £ 12.19

TAKE CARE OF CONCRETE DUST AND SLURRY IN A SMART EASY AND EFFICIENT WAY!

SEE THE SYSTEMS GUIDE ON PAGE 68

FLOOR GRINDING SYSTEMS WITH OUTSTANDING PRODUCTION RATES

Preparing, grinding and polishing of concrete floors as well as repairing and polishing of terrazzo and other natural stone, are demanding jobs. Our mission is to enable you to perform at your maximum potential, by providing you with a system that includes the patented Dual Drive Technology™, the wireless remote control machines PG 820 RC and PG680 RC and the efficient dust management range. Our product range also includes our range of easily transportable and highly useful small PG models. Like all Husqvarna PG machines they are equipped as standard with our quick-fit Redi Lock® diamond tool system.

Range overview.

The range of Husqvarna floor grinders consists of seven models with grinding width from 280 mm to 820 mm and 1.5 kW to 13 kW power, weighing from 70 to 533 kg. You can always find a Husqvarna PG model optimal for your kind of operation.

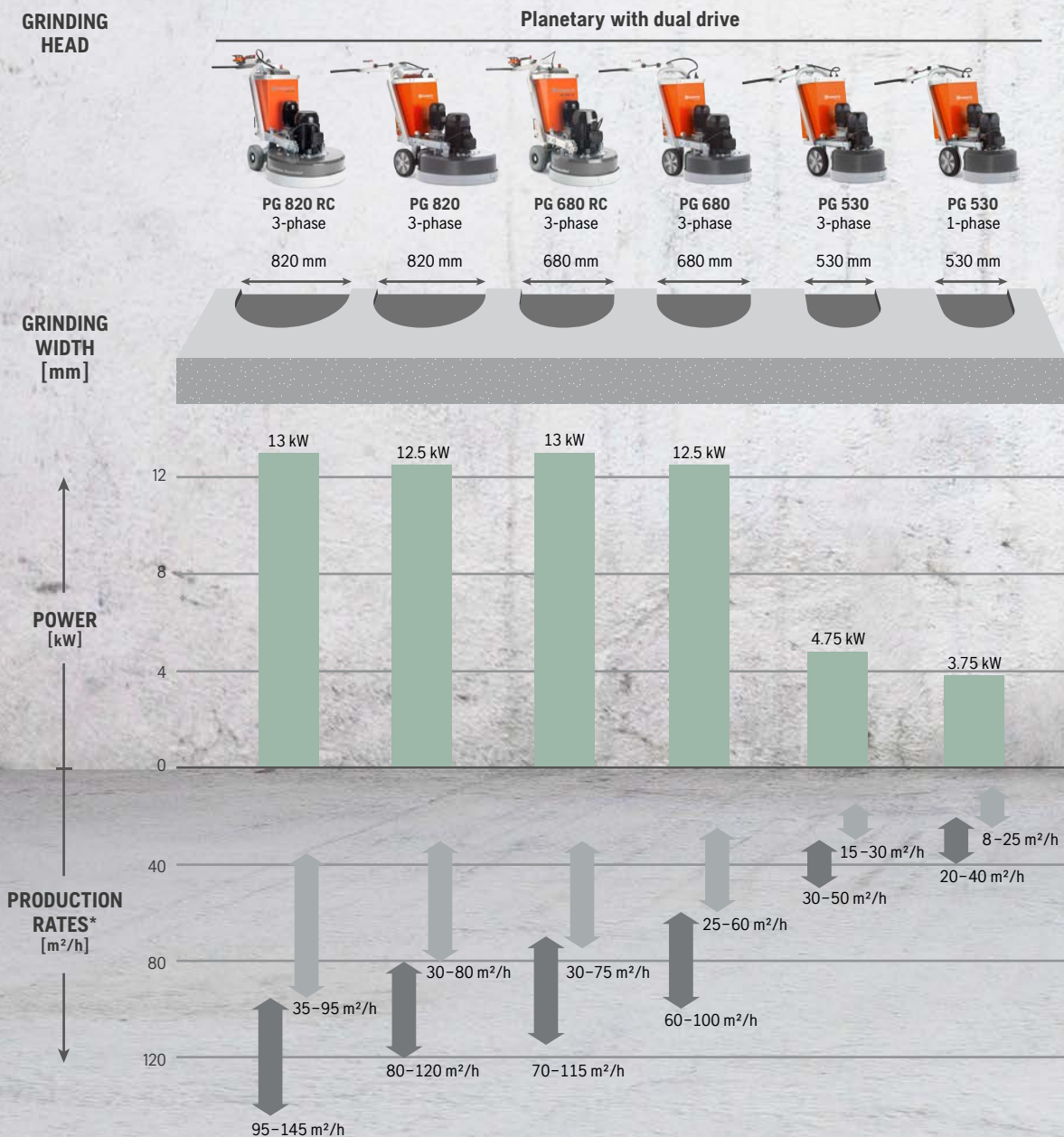



GRINDERS	PG 820 RC	PG 820	PG 680 RC
TECHNICAL SPECIFICATIONS			
Power, kW (machine only)	13.0	12.5	13.0
Power, kW (with recommended dust collector)	18.75	18.75	18.75
Voltage, V	400	400	400
Rated current, A	32	32	32
Power supply	3-phase	3-phase	3-phase
Grinding width, mm	820	820	680
Grinding disc, mm	3×270	3×270	3×230
Grinding pressure total, kg	290	335	269
Grinding disc speed, rpm	250–1100	250–1100	250–1100
Direction of rotation	Independent FWD/REV direction control on both grinding discs and planetary head	Independent FWD/REV direction control on both grinding discs and planetary head	Independent FWD/REV direction control on both grinding discs and planetary head
Dimensions (L×W×H), mm	1370×820×1230	1370×820×1230	1150×680×1220
Weight, kg	533	455	500
REMOTE CONTROLLED FEATURES			
Self drive	●	—	●
Battery power for transportation	●	—	●
Parameter settings/reading	●	—	●
RECOMMENDED EQUIPMENT			
	DC 6000, T 10000, T 7500	DC 6000, T 10000, T 7500	DC 6000, T 10000, T 7500
GENERATOR AND TRANSFORMER INFORMATION			
Minimum transformer size, VA	—	—	—
Transformer Continuous or Intermittent	—	—	—
Minimum Generator, k VA (machine only)	39	37.5	39
Minimum Generator, k VA (with recommended dust collector)	56.25	56.25	56.25
ARTICLE INFORMATION			
	967 30 29-01	965 19 56-07	967 62 27-01
RRP EXC VAT	£ POA	£ POA	£ POA



PG 680	PG 530	PG 450	PG 400	PG 280
12.5	4.75/3.75	2.2/1.5	4.0	2.2/1.5
18.75	11.25	5.2/4.5	10.5	3/3
400	400/230	230/110	415	230/110
32	16	16/14	16	16/14
3-phase	3-phase /1-phase	1-phase	3-phase	1-phase
680	530	450	400	280
3×230	3×230	3×180	400	280
300	134	69	73	41
250–1100	200–1000/200–710	705	1445	1400/1000
Independent FWD/REV direction control on both grinding discs and planetary head	FWD/REV with grinding discs and planetary head rotation in same direction (not counter-rotation)	–	–	–
1150×680×1220	1100×530×1150	1310×482×1144	1400×435×1050	1200×305×1000
400	210	109	115	70
–	–	–	–	–
–	–	–	–	–
–	–	–	–	–
DC 6000, T 10000, T 7500	T 7500 (3-phase) / S 36 (1-phase)	S 26	S 36	S 26
–	–	2000	–	2000 (3375 with recommended dust collector)
–	–	Continuous	–	Continuous
37.5	15	4.5	15	4.5
56.25	33.75	16	32	8.1
965 19 57-07	965 19 58-12, 3-phase 965 19 58-11, 1-phase	967 64 86-01, 230 V 967 27 81-07, 110 V	967 64 85-01, 5 pin	967 64 87-01, 230 V 967 64 87-05, 110 V
£ POA	£ POA £ POA	110 V – £ 4,610.02 230 V – £ 4,663.41	£ 3,663.42	110 V – £ 2,656.00 230 V – £ 2,796.33

**TAKE CARE OF CONCRETE
DUST AND SLURRY IN A SMART
EASY AND EFFICIENT WAY!**

SEE THE SYSTEMS GUIDE ON PAGE 68



1 Redi Lock diamond holder disc for PG 820



2 Redi Lock diamond holder disc for PG 680 and PG 530



3 Redi Lock diamond holder disc for PG 450



4 Flexible grinding head spring steel replacement for PG 820



5 Flexible grinding head spring steel replacement for PG 680



6 Resin holder disc



7 Resin holder disc replacement rubber pad



8 Resin holder disc replacement velcro pad



9 Redi Lock resin pad adapter for PG 400 and PG 280



10 Water kit for PG 820 and PG 680



11 HR 820 head, for heavy removal and preparation



12 HR 680 head, for heavy removal and preparation



13 Replacement flexible grinding head for PG 530



14 Silicone ring for heavy removal head



15 Silicone ring



16 Pin



17 Head lock



18 Head lock screw



19 Rubber skirt, non marking



20 Waist belt, remote control



21 Transport wheel for PG 820 RC and PG 680 RC



22 Brush list for PG 450 and PG 400



23 Brush list kit, back, front and sides for PG 280



24 Transport trolley



25 Tool box



26 Counterweights

Husqvarna PG 820 RC and PG 820.

ACCESSORIES AND SPARE PARTS	RRP	EXC	VAT
1 Redi Lock diamond holder disc	502 53 22-01	£ 145.74	
4 Flexible grinding head spring steel replacement	502 53 42-01	£ 13.56	
6 Resin holder disc	587 15 49-02	£ 209.87	
7 Resin holder disc replacement rubber pad	502 53 19-01	£ 49.58	
8 Resin holder disc replacement velcro pad	587 15 47-01	£ 12.98	
10 Water kit	505 45 32-01	£ 96.08	
11 HR 820 head, for heavy removal and preparation	502 53 38-01	£ 166.22	
14 Silicone ring (for heavy removal head)	502 53 43-01	£ 18.22	
15 Silicone ring	502 53 39-01	£ 5.78	
16 Pin	522 65 98-03	£ 1.46	
17 Head lock	502 53 44-01	£ 2.18	
18 Head lock screw	725 53 70-51	£ 0.92	
19 Rubber skirt, non marking	590 49 92-03	£ 77.76	
20 Waist belt, remote control (PG 820 RC)	501 79 31-01	£ 422.42	
21 Transport wheel (PG 820 RC)	586 73 46-01	£ 719.00	
24 Transport trolley	501 68 51-02	£ 476.60	
25 Tool box	501 68 51-01	£ 60.72	
On site part kit (PG 820 RC)	588 46 63-01	£ 701.90	

Husqvarna PG 680 RC and PG 680.

ACCESSORIES AND SPARE PARTS	RRP	EXC	VAT
2 Redi Lock diamond holder disc	502 54 58-01	£ 145.74	
5 Flexible grinding head spring steel replacement	502 54 82-01	£ 11.97	
6 Resin holder disc	587 15 95-02	£ 104.99	
7 Resin holder disc replacement rubber pad	502 54 55-01	£ 87.70	
8 Resin holder disc replacement velcro pad	587 15 94-01	£ 4.31	
10 Water kit	505 45 32-01	£ 96.08	
12 HR 680 head, for heavy removal and preparation	502 54 78-01	£ 155.85	
14 Silicone ring (for heavy removal head)	502 53 43-01	£ 18.22	
15 Silicone ring	502 53 39-01	£ 5.78	
16 Pin	522 65 98-03	£ 1.46	
17 Head lock	502 53 44-01	£ 2.18	
18 Head lock screw	725 53 70-51	£ 0.92	
19 Rubber skirt, non marking	590 49 92-02	£ 78.14	
20 Waist belt, remote control (PG 680 RC)	501 79 31-01	£ 422.42	
21 Transport wheel (PG 680 RC)	588 76 79-01	£ 668.14	
24 Transport trolley	501 68 51-02	£ 476.60	
25 Tool box	501 68 51-01	£ 60.72	
On site part kit (PG 680 RC)	501 44 14-01	£ 548.36	

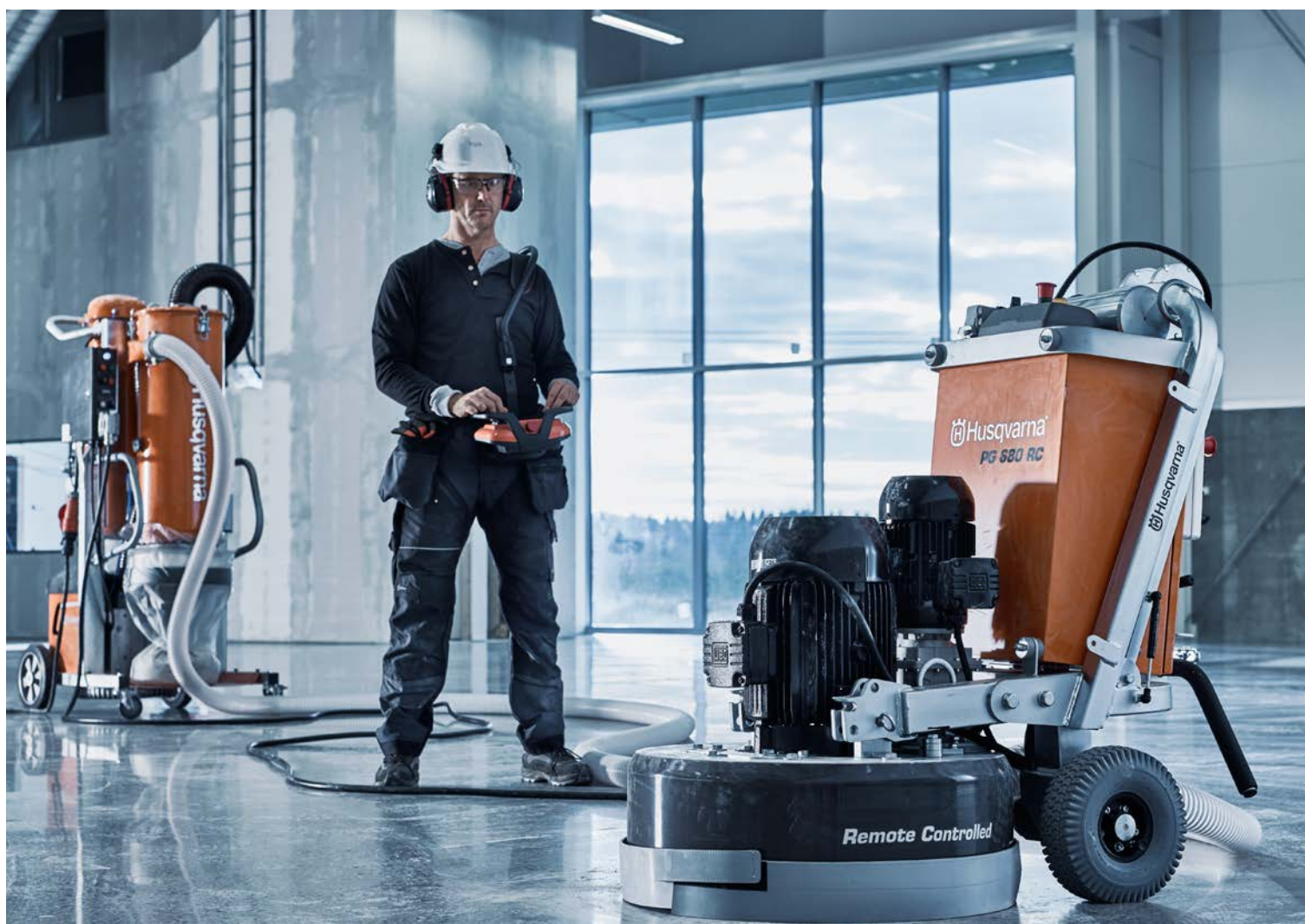

Husqvarna PG 530.

ACCESSORIES AND SPARE PARTS		RRP	EXC VAT
2	Redi Lock diamond holder disc	502 54 58-01	£ 145.74
6	Resin holder disc	587 15 95-02	£ 104.99
7	Resin holder disc replacement rubber pad	502 54 55-01	£ 87.70
8	Resin holder disc replacement velcro pad	587 15 94-01	£ 4.31
13	Replacement flexible grinding head	502 55 82-01	£ 117.56
15	Silicone ring	502 53 39-01	£ 5.78
16	Pin	522 65 98-03	£ 1.46
17	Head lock	725 53 70-55	£ 1.23
18	Head lock screw	725 53 70-51	£ 0.92
19	Rubber skirt, non marking	502 55 89-01	£ 87.10
24	Transport trolley	501 68 51-02	£ 476.60
25	Tool box	501 68 51-01	£ 60.72

Husqvarna PG 450.

ACCESSORIES AND SPARE PARTS		RRP	EXC VAT
3	Redi Lock diamond holder disc	584 85 02-01	£ 74.48
6	Resin holder disc	587 41 02-02	£ 86.27
22	Brush list	585 13 84-05	£ 102.23
24	Transport trolley	501 68 51-02	£ 476.60
25	Tool box	501 68 51-01	£ 60.72
	Resin holder disc replacement rubber pad	585 59 19-01	£ 21.67
	Resin holder disc replacement velcro pad	587 41 01-01	£ 10.97

Husqvarna PG 400 and PG 280.

ACCESSORIES AND SPARE PARTS		RRP	EXC VAT
9	Redi Lock resin pad adapter, Ø 75 mm	587 65 27-01	£ 28.74
22	Brush list (PG 400)	585 13 84-04	£ 109.47
23	Brush list kit, back, front, sides (PG 280)	501 82 88-01	£ 45.13
24	Transport trolley	501 68 51-02	£ 476.60
25	Tool box	501 68 51-01	£ 60.72
26	Counterweight, 3 kg	589 83 72-01	£ 43.71
	4× Screw for counterweight, 3 kg	725 54 53-01	£ 1.22
	4× Washer for counterweight, 3 kg	734 11 63-01	£ 1.40
26	Counterweight, 4 kg	589 83 71-01	£ 81.23
	4× Screw for counterweight, 4 kg	725 54 60-01	£ 4.22
	4× Washer for counterweight, 4 kg	734 11 63-01	£ 1.40
	2× Bushing for counterweight, 4 kg	590 20 34-01	£ 3.07
	Resin holder disc replacement rubber pad	588 16 90-01	£ 9.51
	Resin holder disc replacement velcro pad	587 65 17-01	£ 4.26



SCARIFIERS	CG 200
TECHNICAL SPECIFICATIONS	
Power, kW	3.6
Voltage, V	NA
Rated current, A	NA
Power supply	Petrol
Grinding width, mm	200
Cutting depth, max, mm	13
Recommended cutting depth, mm	0-4
Vacuum port connection, Ø mm	50
Belt	Single, poly-V
Drum rotation speed (maximum off load), rpm	1,350
Dimensions (L×W×H), mm	780 × 470 × 730
Weight (excluding tool drum), kg	54
RECOMMENDED EQUIPMENT	
	S36
ARTICLE INFORMATION	
	967 66 23-01, Petrol, Honda 3.6 kW
RRP EXC VAT	£ 1,614.58

Husqvarna CG 200.

SPARE PARTS		
Spare shaft	543 04 02-11	£ 13.24
Brush alone, steel	543 04 60-23	£ 74.16
Belt (petrol and electric versions)	543 04 49-80	£ 20.24
Bearing complete, right	543 04 18-71	£ 44.25
Bearing complete, left	543 04 50-51	£ 28.90
Shaft complete	543 04 18-30	£ 46.64
Wheel front	543 04 59-36	£ 22.15
Wrench	543 04 58-93	£ 1.73

Husqvarna CG 200 is a highly productive scarifier, designed to remove concrete faster and more aggressively than grinders. Applications include removing coatings (even heavy floor tile mastics and rubbery elastomeric or epoxy materials), light or heavy milling, grooving walkways to make them slip resistant, removing trip hazards in sidewalks, and levelling misaligned concrete joints and uneven surfaces. Equipped with vibration-damping handles for operator comfort, millimetre adjustment for precise depth of operation setting and central exhaust for dust extraction for a cleaner working environment.



**TAKE CARE OF CONCRETE
DUST AND SLURRY IN A SMART
EASY AND EFFICIENT WAY!**

SEE THE SYSTEMS GUIDE ON PAGE 68



DIAMOND TOOLS FOR SURFACE PREPARATION AND FLOOR TREATMENT PRODUCTS

When it comes to grinding and polishing concrete surfaces or removing previous treatments, we're often talking about work that is both difficult, strenuous and time consuming. By listening to our customers we have been able to build a range of tools to fit every step of the surface preparation process. Whatever level of finish you are looking for, Husqvarna offers an array of tools developed for use with most materials. From the hardest concrete floor to the most abrasive, to meet demands for cutting speed and surface finish.

Metal-bond diamond tools – Redi Lock.

Sturdy, metal-bonded diamond tools for every application. An instant and hassle-free system – switch the entire sets of diamonds instantly without any tooling. Its strong base plate is integrated making the locking system very sturdy and safe. The need for multiple sets of diamond holder discs for different sets of diamond tooling is eliminated. The system is available for a variety of machine manufacturers. With six different types of products, G1400 series offers excellent removal rate and durability, providing maximum profitability and performance with all types of applications. G600 range offers a good simple alternative. Perfect for smaller jobs.



See page 16 for more information.

APPLICATION GUIDE	ELITE-GRIND G 1400					VARI-GRIND G 600			PIRANHA™	SHARX™
	G 1410	G 1420	G 1440	G 1470	G 1480	G 620	G 640	G 670		
REMOVAL – MATERIAL										
Porous ceramic glues	—	—	—	●●●	●●	—	—	●●●	●●●	—
Plastic-like ceramic glues	—	●	●●●	—	—	●	●●●	—	●●●	—
Vinyl glues*	●	●●	●●●	●	●	●●	●●●	●	—	—
Paint and thin epoxy (<2 mm)	●	●●	●●●	●	●	●●	●●●	●	—	—
Thick epoxy (15–40 mm)	—	●	●●●	●	—	●	●●●	●	●●●	—
GRINDING – MATERIAL										
Rain-damaged concrete	—	—	—	●●	●●●	—	●	●●	●	—
Concrete, soft	—	—	—	●●●	●●	—	●●	●●●	●	—
Concrete, medium hard	—	●	●●●	●	—	●	●●●	●	—	—
Concrete, hard	●●●	●●●	●	—	—	●●●	●	—	—	●●●
Semi-polished concrete	●●●	●	—	—	—	●	—	—	—	●●●
RECOMMENDED EQUIPMENT	PG 820, PG 820 RC, PG 680, PG 680 RC, PG 530, PG 450, PG 400, PG 280									

●●● = Optimal ●● = Good ● = Acceptable — = Not recommended

*The advised tooling for this application depends on the type of concrete under the material being removed. Husqvarna recommends starting with a harder bond (G 1470 or G 1450), and moving to a softer bond if productivity is not satisfactory.



A **B** **C** **D** **E**
G 14 44 D

A	APPLICATION	B	LEVEL OF PERFORMANCE	C	BOND TYPE	RELATED APPLICATION
G	for grinding application	G 1400		G 1410		Very soft tool to grind the hardest floors
				G 1420		Soft tool for hard surface grinding
				G 1440		Medium tool for medium concrete
				G 1470		Hard tool for soft and abrasive concrete
				G 1480		Very hard tool for very abrasive concrete
		G 600		G 620		Soft tool for hard surface grinding
				G 640		Medium tool for medium type concrete
				G 670		Hard tool for soft and abrasive concrete

D	GRIT SIZE REF.	RELATED MESH SIZE
2		16
3		20
4		30
5		50
6		100

E	REF.	SEGMENT
S		Single
D		Double
T		Triple

Husqvarna Elite-Grind G 1400.

A gold level range of metal-bond diamond tools for the Redi Lock system, providing maximum productivity and excellent results. Ideal for HIPERFLOOR jobs. Available in a wide assortment of various bond hardnesses and grit sizes, all easily identified by colour and segment shape.

Grit size

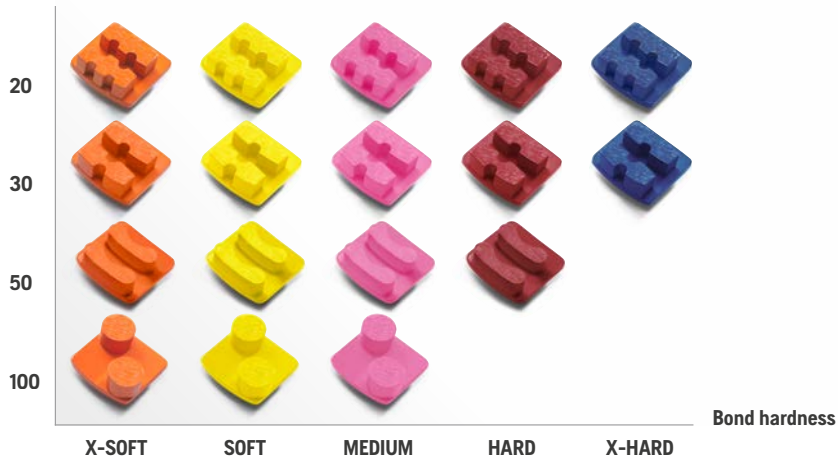

PRODUCT NUMBER	NAME	COLOUR	SINGLE/DOUBLE	SEGMENT HEIGHT, MM	GRIT SIZE (MESH)	SHAPE	BOND HARDNESS	RRP EXC VAT
G 1410 (3 pcs)								
501 89 79-01	G1413S	Orange	Single	13	20	Two notch	X-Soft	£ 192.00
501 89 79-02	G1413D	Orange	Double	13	20	Two notch	X-Soft	£ 299.00
501 89 89-01	G1414S	Orange	Single	13	30	One notch	X-Soft	£ 192.00
501 89 89-02	G1414D	Orange	Double	13	30	One notch	X-Soft	£ 299.00
501 89 92-01	G1415S	Orange	Single	13	50	Round	X-Soft	£ 192.00
501 89 92-02	G1415D	Orange	Double	13	50	Round	X-Soft	£ 299.00
501 89 97-01	G1416S	Orange	Single	13	100	Round	X-Soft	£ 192.00
501 89 97-02	G1416D	Orange	Double	13	100	Round	X-Soft	£ 299.00
G 1420 (3 pcs)								
501 89 99-01	G 1423S	Yellow	Single	13	20	Two notch	Soft	£ 192.00
501 89 99-02	G1423D	Yellow	Double	13	20	Two notch	Soft	£ 299.00
501 90 07-01	G 1424S	Yellow	Single	13	30	One notch	Soft	£ 192.00
501 90 07-02	G1424D	Yellow	Double	13	30	One notch	Soft	£ 299.00
501 90 08-01	G 1425S	Yellow	Single	13	50	Round	Soft	£ 192.00
501 90 08-02	G1425D	Yellow	Double	13	50	Round	Soft	£ 299.00
501 90 15-01	G 1426S	Yellow	Single	13	100	Round	Soft	£ 192.00
501 90 15-02	G1426D	Yellow	Double	13	100	Round	Soft	£ 299.00
G 1440 (3 pcs)								
501 90 25-01	G 1443S	Pink	Single	13	20	Two notch	Medium	£ 192.00
501 90 25-02	G1443D	Pink	Double	13	20	Two notch	Medium	£ 299.00
501 90 49-01	G 1444S	Pink	Single	13	30	One notch	Medium	£ 192.00
501 90 49-02	G1444D	Pink	Double	13	30	One notch	Medium	£ 299.00
501 90 65-01	G 1445S	Pink	Single	13	50	Round	Medium	£ 192.00
501 90 65-02	G1445D	Pink	Double	13	50	Round	Medium	£ 299.00
501 90 74-01	G 1446S	Pink	Single	13	100	Round	Medium	£ 192.00
501 90 74-02	G1446D	Pink	Double	13	100	Round	Medium	£ 299.00
G 1470 (3 pcs)								
501 90 77-01	G 1473S	Red	Single	13	20	Two notch	Hard	£ 192.00
501 90 77-02	G1473D	Red	Double	13	20	Two notch	Hard	£ 299.00
501 90 79-01	G 1474S	Red	Single	13	30	One notch	Hard	£ 192.00
501 90 79-02	G1474D	Red	Double	13	30	One notch	Hard	£ 299.00
501 90 81-01	G 1475S	Red	Single	13	50	Round	Hard	£ 192.00
501 90 81-02	G1475D	Red	Double	13	50	Round	Hard	£ 336.00
G 1480 (3 pcs)								
501 90 82-01	G 1483D	Blue	Double	13	20	Two notch	X-Hard	£ 299.00
501 90 82-02	G1483T	Blue	Triple	13	20	Two notch	X-Hard	£ 466.00
501 90 83-01	G 1484D	Blue	Double	13	30	One notch	X-Hard	£ 299.00
501 90 83-02	G1484T	Blue	Triple	13	30	One notch	X-Hard	£ 466.00

Husqvarna Vari-Grind G 600.

A silver level range of metal-bond diamond tools for the Redi Lock system, providing great work result in allround surface prep applications. Ideal for rental and domestic use. Available in various bond hardness and grit sizes, easily identified by colour and segment shape.

Grit size

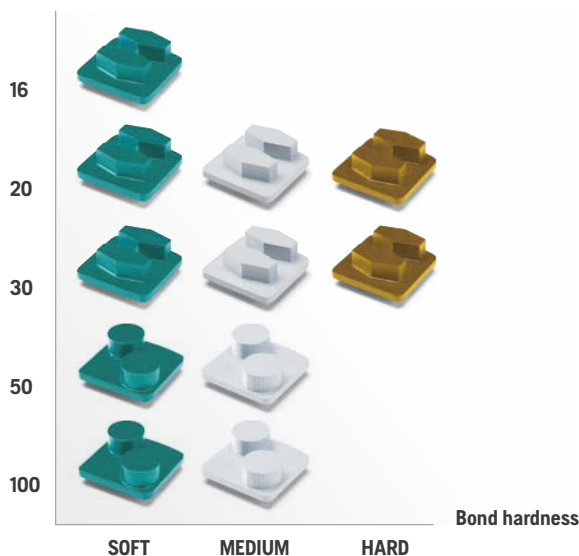

PRODUCT NUMBER	NAME	COLOUR	SINGLE / DOUBLE	SEGMENT HEIGHT, MM	GRIT SIZE (MESH)	SHAPE	BOND HARDNESS	RRP EXC VAT
G 620 (3 pcs)								
503 84 79-01	G 622D	Green	Double	10	16	Hexagonal	Soft	£ 192.00
503 84 79-02	G 623S	Green	Single	10	20	Hexagonal	Soft	£ 135.00
503 84 79-03	G 623D	Green	Double	10	20	Hexagonal	Soft	£ 192.00
503 84 79-04	G 624S	Green	Single	10	30	Hexagonal	Soft	£ 135.00
503 84 79-05	G 624D	Green	Double	10	30	Hexagonal	Soft	£ 192.00
503 84 79-06	G 625S	Green	Single	10	50	Round	Soft	£ 135.00
503 84 79-07	G 625D	Green	Double	10	50	Round	Soft	£ 192.00
503 84 79-08	G 627S	Green	Single	10	100	Round	Soft	£ 135.00
503 84 79-09	G 627D	Green	Double	10	100	Round	Soft	£ 192.00
G 640 (3 pcs)								
503 88 34-01	G 643S	Grey	Single	10	20	Hexagonal	Medium	£ 135.00
503 88 34-02	G 643D	Grey	Double	10	20	Hexagonal	Medium	£ 192.00
503 88 34-03	G 644S	Grey	Single	10	30	Hexagonal	Medium	£ 135.00
503 88 34-04	G 644D	Grey	Double	10	30	Hexagonal	Medium	£ 192.00
503 88 34-05	G 645S	Grey	Single	10	50	Round	Medium	£ 135.00
503 88 34-06	G 645D	Grey	Double	10	50	Round	Medium	£ 192.00
503 88 34-07	G 647S	Grey	Single	10	100	Round	Medium	£ 135.00
503 88 34-08	G 647D	Grey	Double	10	100	Round	Medium	£ 192.00
G 670 (3 pcs)								
503 88 55-01	G 673S	Gold	Single	10	20	Hexagonal	Hard	£ 135.00
503 88 55-02	G 673D	Gold	Double	10	20	Hexagonal	Hard	£ 192.00
503 88 55-03	G 674S	Gold	Single	10	30	Hexagonal	Hard	£ 135.00
503 88 55-04	G 674D	Gold	Double	10	30	Hexagonal	Hard	£ 192.00

Husqvarna Piranha™.

For removal of hard-to-remove coatings, adhesives and screeds. Maximum wear and productivity with Husqvarna's Piranha™ diamond scraper inserts. For use in conjunction with the Redi Lock system.



PRODUCT NUMBER	NAME	DESCRIPTION	ROTATION	RECOMMENDED WITH	RRP EXC VAT
543 32 73-01	G11X1S	Single Piranha™ plate	Anti-clockwise direction	PG 820, PG 820 RC, PG 680, PG 680 RC, PG 530, PG 450, PG 400, PG 280	£ 237.00
543 32 73-02	G11X1D	Double Piranha™ plate	Anti-clockwise direction	PG 820, PG 820 RC, PG 680, PG 680 RC, PG 530, PG 450, PG 400, PG 280	£ 387.00
543 32 73-03	G11Y1D	Double Piranha™ plate	Clockwise direction		£ 387.00

Husqvarna Sharx™.

For fast and easy removal of dense surfaces on hard-troweled concrete floors. The Sharx™ metal bond significantly increases the productivity and ensures that the pads stay opened and sharp even on the hardest top layers.



PRODUCT NUMBER	NAME	COLOUR	SINGLE/DOUBLE	BOND HARDNESS	RRP EXC VAT
574 43 04-02	Sharx™ - Single 3-pack	Silver	Single	Sharx™	£ 192.00
574 43 04-03	Sharx™ - Double 3-pack	Silver	Double	Sharx™	£ 299.00

POLISHING TOOLS FOR DRY AND WET APPLICATIONS

Polishing pad delivering exceptional gloss and clarity when used for dry and wet polishing of concrete, terrazzo and some natural stones. Highly recommended for use in conjunction with Hiperhard™ floor densifier/hardener in the HIPERFLOOR concrete polishing system.

Polishing range overview.

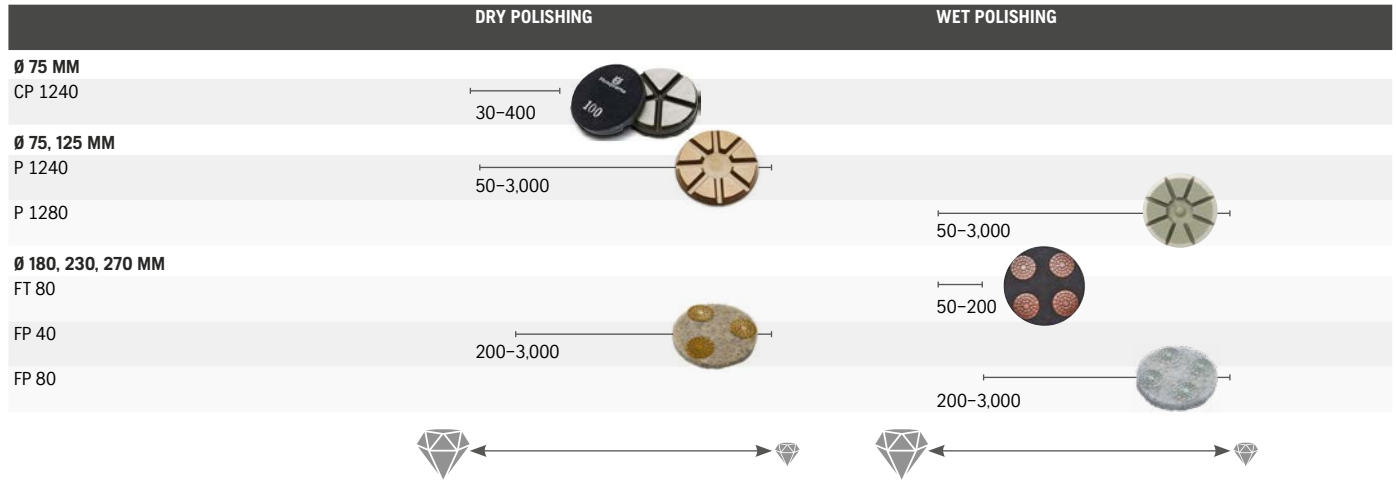

Husqvarna P 1200.

Professional tools developed to reach a maximum gloss in fewer steps, which saves time and tooling and gives a better end result.



PRODUCT NUMBER	NAME	COLOUR	DIAMETER, MM	GRIT SIZE (MESH)	DIAMOND HEIGHT, MM	RRP EXC VAT
FOR PG MACHINES, DRY APPLICATION						
574 42 82-01	P1242	Dark green	76	50	6.5	£ 48.00
574 42 83-01	P1243	Black	76	100	6.5	£ 48.00
574 42 84-01	P1244	Red	76	200	6.5	£ 48.00
574 42 85-01	P1245	Yellow	76	400	6.5	£ 48.00
574 42 86-01	P1246	White	76	800	6.5	£ 48.00
574 42 87-01	P1247	Blue	76	1.500	6.5	£ 48.00
574 42 88-01	P1248	Grey	76	3.000	6.5	£ 48.00
FOR HANDHELD MACHINES, DRY APPLICATION						
574 42 89-01	P1242	Dark green	125	50	2.8	£ 65.00
574 42 90-01	P1243	Black	125	100	2.8	£ 65.00
574 42 91-01	P1244	Red	125	200	2.8	£ 65.00
574 42 92-01	P1245	Yellow	125	400	2.8	£ 65.00
574 42 93-01	P1246	White	125	800	2.8	£ 65.00
574 42 96-01	P1247	Blue	125	1.500	2.8	£ 65.00
575 42 97-01	P1248	Grey	125	3.000	2.8	£ 65.00
FOR PG MACHINES, WET APPLICATION						
582 32 59-05	P1282	Dark green	76	50	6.5	£ 48.00
582 32 59-04	P1283	Black	76	100	6.5	£ 48.00
582 32 59-01	P1284	Red	76	200	6.5	£ 48.00
582 32 59-03	P1285	Yellow	76	400	6.5	£ 48.00
582 32 59-06	P1286	White	76	800	6.5	£ 48.00
582 32 79-07	P1287	Blue	76	1.500	6.5	£ 48.00
582 32 59-08	P1288	Grey	76	3.000	6.5	£ 48.00
FOR HANDHELD MACHINES, WET APPLICATION						
589 77 19-01	P1282	Dark green	125	50	2.8	£ 64.00
589 77 19-02	P1283	Black	125	100	2.8	£ 64.00
589 77 19-03	P1284	Red	125	200	2.8	£ 64.00
589 77 19-04	P1285	Yellow	125	400	2.8	£ 64.00
589 77 19-05	P1286	White	125	800	2.8	£ 64.00
589 77 19-06	P1287	Blue	125	1.500	2.8	£ 64.00
589 77 19-07	P1288	Grey	125	3.000	2.8	£ 64.00

Adapters for resin tools.

PRODUCT NUMBER	NAME	RRP EXC VAT
580 28 96-01	Redi Lock resin pad adapter, Ø 75 mm	£ 32.48
505 49 05-01	Pad adapter for handheld machines, Ø 125 mm	£ 26.37
584 47 06-01	Adapter plate for resin pads HTC 420	
505 55 64-01	Adapter plate for resin pads HTC 420	
505 55 63-01	Adapter plate for resin pads HTC 500/560	
505 55 62-01	Adapter plate for resin pads HTC 800/950	



Husqvarna HiperFlex.

Resin-bonded polishing tools on a flexible backing pad. Used dry for overlays and high quality polished concrete surfaces. For all our planetary grinders.

PRODUCT NUMBER	NAME	DIMENSION, MM	GRIT SIZE (MESH)	MACHINE APPLICATION	RRP EXC VAT
HIPERFLEX FP 40 DRY					
587 54 67-01	FP44	180	200	PG 450	£ 104.88
587 54 67-02	FP45	180	400	PG 450	£ 104.88
587 54 67-03	FP46	180	800	PG 450	£ 104.88
587 54 67-04	FP47	180	1,500	PG 450	£ 104.88
587 54 67-05	FP48	180	3,000	PG 450	£ 104.88
542 77 93-16	FP44	230	200	PG 680 / PG 530	£ 138.92
542 77 93-17	FP45	230	400	PG 680 / PG 530	£ 138.92
542 77 93-18	FP46	230	800	PG 680 / PG 530	£ 138.92
542 77 93-19	FP47	230	1,500	PG 680 / PG 530	£ 138.92
542 77 93-20	FP48	230	3,000	PG 680 / PG 530	£ 138.92
542 87 00-56	FP44	270	200	PG 820	£ 173.88
542 86 84-07	FP45	270	400	PG 820	£ 173.88
542 86 84-08	FP46	270	800	PG 820	£ 173.88
542 86 84-09	FP47	270	1,500	PG 820	£ 173.88
542 86 84-10	FP48	270	3,000	PG 820	£ 173.88
HIPERFLEX FP 80 WET					
589 63 37-01	FP84	180	200	PG 450	£ 130.18
589 63 37-02	FP85	180	400	PG 450	£ 130.18
589 63 37-03	FP86	180	800	PG 450	£ 130.18
589 63 37-04	FP87	180	1,500	PG 450	£ 130.18
589 63 37-05	FP88	180	3,000	PG 450	£ 130.18
589 63 39-01	FP84	230	200	PG 530 / PG 680	£ 165.60
589 63 39-02	FP85	230	400	PG 530 / PG 680	£ 165.60
589 63 39-03	FP86	230	800	PG 530 / PG 680	£ 165.60
589 63 39-04	FP87	230	1,500	PG 530 / PG 680	£ 165.60
589 63 39-05	FP88	230	3,000	PG 530 / PG 680	£ 165.60
589 63 41-01	FP84	270	200	PG 820	£ 206.08
589 63 41-02	FP85	270	400	PG 820	£ 206.08
589 63 41-03	FP86	270	800	PG 820	£ 206.08
589 63 41-04	FP87	270	1,500	PG 820	£ 206.08
589 63 41-05	FP88	270	3,000	PG 820	£ 206.08
HIPERFLEX FT 80 WET					
589 63 36-01	FT82	180	50	PG 450	£ 155.48
589 63 36-02	FT83	180	100	PG 450	£ 155.48
589 63 36-03	FT84	180	200	PG 450	£ 155.48
589 63 38-01	FT82	230	50	PG 530 / PG 680	£ 194.12
589 63 38-02	FT83	230	100	PG 530 / PG 680	£ 194.12
589 63 38-03	FT84	230	200	PG 530 / PG 680	£ 194.12
589 63 40-01	FT82	270	50	PG 820	£ 232.76
589 63 40-02	FT83	270	100	PG 820	£ 232.76
589 63 40-03	FT84	270	200	PG 820	£ 232.76

CERAMIC DRY GRINDING AND POLISHING TOOLS

Ceramic tools for dry grinding and polishing of concrete. Aggressive tool for grinding and honing of concrete, which will leave an excellent scratch pattern. Long life offers excellent value for money.



Husqvarna CP 1200.

Premium tools for industrial finished concrete floor.

PRODUCT NUMBER	NAME	COLOUR	DIAMETER, MM	GRIT SIZE (MESH)	DIAMOND HEIGHT, MM	RRP EXC VAT
577 31 70-04	CP 1241	Purple	75	30	6.5	£ 146.03
577 31 70-01	CP 1242	Dark green	75	50	6.5	£ 146.03
577 31 70-02	CP 1243	Black	75	100	6.5	£ 146.03
577 31 70-05	CP 1244	Red	75	200	6.5	£ 146.03
577 31 70-03	CP 1245	Yellow	75	400	6.5	£ 146.03

MAINTENANCE PADS

Diamond impregnated pads that are ideal for cleaning concrete polished floors. Use with Husqvarna PG 450, PG 530, PG 680 and PG 820 grinders.



Husqvarna HiperClean Dry Pads.

Ideal for cleaning concrete polished floors. Use with PG 450, PG 530, PG 680 and PG 820 Husqvarna grinders, hand tooling and burnishing equipment.

PRODUCT NUMBER	DIMENSION, MM / INCHES	GRIT SIZE (MESH)	MACHINE APPLICATION	RRP EXC VAT
542 87 00-76	127 / 5"	400	Hand Grinder	£ 21.95
542 87 00-77	127 / 5"	800	Hand Grinder	£ 21.95
542 87 00-78	127 / 5"	1,500	Hand Grinder	£ 21.95
542 87 00-79	127 / 5"	3,000	Hand Grinder	£ 21.95
501 76 40-07	180 / 7"	400	PG 450	£ 41.07
501 76 40-01	180 / 7"	800	PG 450	£ 41.07
501 76 40-02	180 / 7"	1,500	PG 450	£ 41.07
501 76 40-03	180 / 7"	3,000	PG 450	£ 41.07
501 76 40-08	230 / 9"	400	PG 530, PG 680	£ 46.99
501 76 40-04	230 / 9"	800	PG 530, PG 680	£ 46.99
501 76 40-05	230 / 9"	1,500	PG 530, PG 680	£ 46.99
501 76 40-06	230 / 9"	3,000	PG 530, PG 680	£ 46.99
501 76 40-09	270 / 10"	400	PG 820	£ 51.43
501 76 40-10	270 / 10"	800	PG 820	£ 51.43
501 76 40-11	270 / 10"	1,500	PG 820	£ 51.43
501 76 40-12	270 / 10"	3,000	PG 820	£ 51.43
589 81 05-05	400 / 16"	400		£ 67.34
589 81 05-06	400 / 16"	800		£ 67.34
589 81 05-07	400 / 16"	1,500		£ 67.34
589 81 05-08	400 / 16"	3,000		£ 67.34
542 87 00-80	430 / 17"	400		£ 69.93
542 87 00-81	430 / 17"	800		£ 69.93
542 87 00-82	430 / 17"	1,500		£ 69.93
542 87 00-83	430 / 17"	3,000		£ 69.93
542 87 00-84	530 / 21"	400		£ 87.00
542 87 00-85	530 / 21"	800		£ 87.00
542 87 00-86	530 / 21"	1,500		£ 87.00
542 87 00-87	530 / 21"	3,000		£ 87.00
542 87 00-88	600 / 24"	400		£ 111.00
542 87 00-89	600 / 24"	800		£ 111.00
542 87 00-90	600 / 24"	1,500		£ 111.00
542 87 00-91	600 / 24"	3,000		£ 111.00
542 87 00-92	685 / 27"	400		£ 139.00
542 87 00-93	685 / 27"	800		£ 139.00
542 87 00-94	685 / 27"	1,500		£ 139.00
542 87 00-95	685 / 27"	3,000		£ 139.00

CUP WHEELS FOR SURFACE PREPARATION

Gold level grinding tools for handheld applications, dedicated to floor specialists and construction professionals. The product range offers the highest performance in all floor preparation applications. The cups are provided with 22.2 bore hole and an M 14 adapter in order to provide more options for the user. The anti-vibration connector decreases the vibration for the user and makes the job less tiring. The effect can be cancelled by using the M 14 adapter.



Husqvarna G 10X1.

For removal of epoxy, vinyls and glues.

PRODUCT NUMBER	NAME	CONNECTOR	DIAMETER, MM	RRP EXC VAT
543 09 34-65	G 10X1	22.2/M14	125	£ 187.22

Husqvarna G 1042.

For epoxy and glue removal.

PRODUCT NUMBER	NAME	CONNECTOR	DIAMETER, MM	RRP EXC VAT
543 09 34-66	G 1042	22.2/M14	125	£ 142.97

Husqvarna G 1073/G1043/G 1013.

For concrete repairs, floor flattening and aggregate exposure.

PRODUCT NUMBER	NAME	APPLICATION	CONNECTOR	DIAMETER, MM	GRIT SIZE (MESH)	RRP EXC VAT
543 09 34-68	G 1013	Hard to very hard concrete	22.2/M14	125	20/30	£ 142.97
543 09 34-69	G 1043	Normal concrete	22.2/M14	125	20/30	£ 142.97
543 09 34-70	G 1073	Abrasive material	22.2/M14	125	20/30	£ 142.97

Husqvarna G 1045/G 1015.

For epoxy and sealer laying preparation.

PRODUCT NUMBER	NAME	APPLICATION	CONNECTOR	DIAMETER, MM	GRIT SIZE (MESH)	RRP EXC VAT
543 09 34-72	G 1015	Normal to hard and very hard concrete	22.2/M14	125	40/50	£ 142.97
543 09 34-74	G 1045	Normal to soft and abrasive concrete	22.2/M14	125	40/50	£ 142.97

Husqvarna G 1017.

For scratch removal and polishing preparation.

PRODUCT NUMBER	NAME	CONNECTOR	DIAMETER, MM	GRIT SIZE (MESH)	RRP EXC VAT
543 09 34-75	G 1017	22.2/M14	125	100/120	£ 142.97



INDUSTRIAL FINISH



COMMERCIAL FINISH

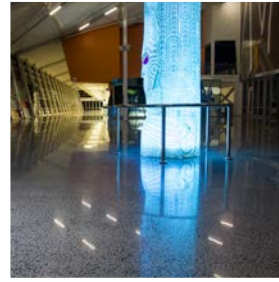

PREMIUM FINISH



FLOOR TREATMENT PRODUCTS

Concrete is one of the most durable surfaces known to man. However by mechanically refining the surface through grinding, polishing and chemical treatment, we can bring the surface to a whole new level of beauty, functionality and strength. With different specified processes, a flooring solution can be tailored to fit any requirement – aesthetic, flatness, gloss and price. Only by using Husqvarna equipment, diamond tools and concrete chemicals can a polished concrete floor truly be called HIPERFLOOR. Husqvarna offers a range of floor treatment products for use in the HIPERFLOOR process to help you achieve a first-class mechanical and aesthetic finish.

Husqvarna GM 3000™.

Specifically formulated for re-grouting and hole filling in concrete surfaces.

PRODUCT NUMBER	NAME	RRP EXC VAT
543 08 71-61	GM 3000™, 20 l	£ 100.80

Husqvarna Hiperhard™/Hiperlith™.

Hiperhard™ is an additional treatment product in the HIPERFLOOR process. It is a potassium densifier applied to the concrete surface, to react with the calcium hydroxide that already exists in the concrete. A crystalline/glassy structure is formed in the pores of the concrete near the surface, and this is a main contributor to increasing the surface hardness of the concrete. The formation of calcium silicate in the concrete, combined with polishing the concrete with resin-bonded diamonds, significantly hardens the floor and improves the abrasion resistance as well as having a significant impact on the appearance of the final floor. It is also available in a lithium-based version called Hiperlith™.

PRODUCT NUMBER	NAME	RRP EXC VAT
543 08 71-65	Hiperhard™, 20 l	£ 186.24
578 27 36-01	Hiperlith™, 20 l	£ 216.99

Husqvarna Hiperguard™ Premium Enhance.

Premium-grade surface impregnator that restricts the absorption of water, oil, fats and dirt. Stains are kept at the surface level, which simplifies maintenance and extends the lifespan of the floor. It also helps enhance the colour of the material being sealed.

PRODUCT NUMBER	NAME	RRP EXC VAT
543 08 74-47	Hiperguard™ PE, 5 l	£ 270.00
543 08 74-48	Hiperguard™ PE, 10 l	£ 513.00

Husqvarna burnishing pads.

Recommended for use in conjunction with Hiperguard™ Premium Enhance.

PRODUCT NUMBER	NAME	RRP EXC VAT
543 08 73-44	Burnishing pad for PG 530 and PG 680, Ø 240 mm	£ 18.60
543 08 73-49	Burnishing pad for PG 820, Ø 270 mm	£ 18.60
574 51 36-01	Velcro for burnishing pads, 240 mm	£ 58.10
574 51 36-02	Velcro for burnishing pads, 270 mm	£ 58.10

SCARIFYING TOOLS

A gold level range of scarifying drums with different steel and carbide wheels that cover applications from coating removal to grooving.

Husqvarna toothed-wheeled cutter.

For dressing concrete and asphalt, levelling surfaces and for anti-slip grooving (corridors, access ramps, stairs, etc), descaling steel decking. By alternating washers and spacers on the four shafts of the drum, user can achieve the desired surface condition: very rough, medium or very fine.

Husqvarna TCT-wheeled cutter (tungsten carbide tipped).

High-performance tool for modifying the surface structure of asphalt and concrete. Very high wear resistance (10 times more life). By alternating washers and spacers on the four shafts of the drum, user can achieve the desired surface condition: very rough, medium or very fine.

Husqvarna star-wheel cutter.

For cleaning concrete and removing epoxy paint, oil, grease, glue and thermoplastic road markings. By alternating washers and spacers on the four shafts of the drum, user can achieve the desired surface condition: very rough, medium or very fine. Available in ready-to-use kits or as spare parts.



A



B



C

Wheels.

PRODUCT NUMBER	DESCRIPTION	DIAMETER,MM	THICKNESS,MM	MACHINE APPLICATION	RRP EXC VAT
543 04 02-14	Star wheel (processed steel) 60 × 2 mm	60	2	CG 200	£ 0.65
543 04 02-09	Toothed wheel (processed steel) 62 × 5 mm	62	5	CG 200	£ 1.20
543 04 02-16	Carbide wheel 56 × 6.5 mm	56	6.5	CG 200	£ 3.34
543 04 02-17	Spacer (3 mm thickness)		3	CG 200	£ 0.25

Naked drum with axis.

PRODUCT NUMBER	DESCRIPTION	DIAMETER,MM	THICKNESS,MM	MACHINE APPLICATION	RRP EXC VAT
A 543 04 02-10	Drum 200 mm large (only)			CG 200	£ 249.00
543 04 02-11	Spare shaft			CG 200	£ 32.00

Complete head assembly kits.

PRODUCT NUMBER	DESCRIPTION	DIAMETER,MM	THICKNESS,MM	MACHINE APPLICATION	RRP EXC VAT
B 543 04 02-21	160 star wheels and 164 spacers	60	2	CG 200	£ 375.00
C 543 04 02-24	84 carbide wheels and 84 spacers	58	7	CG 200	£ 599.00

COMPLETE SYSTEMS FOR BEST-IN-CLASS DUST AND SLURRY MANAGEMENT

Concrete dust and slurry need to be removed in a safe and efficient way to protect you and your team from dust exposure. With Husqvarna, you get access to guidance, knowledge and a broad, fully integrated range of highly efficient equipment for dust and slurry management, enabling you to comply with rules and regulations without compromising your productivity.

By combining our industry expertise in concrete cutting, drilling and grinding with the foremost technology in dust and slurry management, Husqvarna knows how to provide you with easy-to-use solutions that deliver continuous high efficiency over a long time span. Handling the dust and slurry more efficiently means a better way of working.

Range overview.

Husqvarna's range of equipment for dust and slurry management covers all needs and applications within the construction industry – from the compact 1-phase dust extractors and efficient slurry vacuums to the big, powerful 3-phase dust extractors for heavy-duty jobs. The easily portable air cleaners equipped with HEPA H13 filters complete the setup for maximum workplace safety.



Equipment Type	T 10000	T 7500	T 4000	S 26	S 13	W 70 P	W 70	A 2000	A 1000
Core drill motors				●	●	●	●	●	●
Power cutters				●	●	●	●		●
Wall saws						●			
Angle grinders					●				●
Masonry saws				●	●				●
Floor grinders	●	●	●	●	●			●	●
DXR								●	●

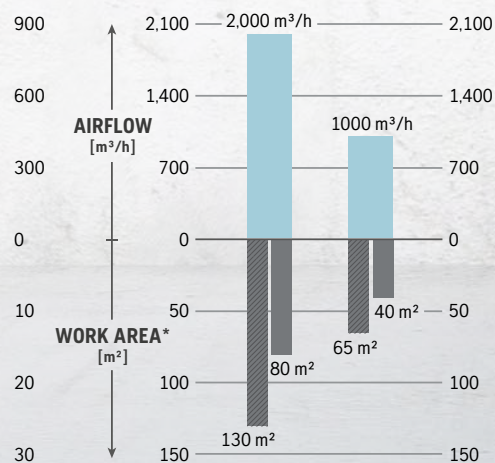
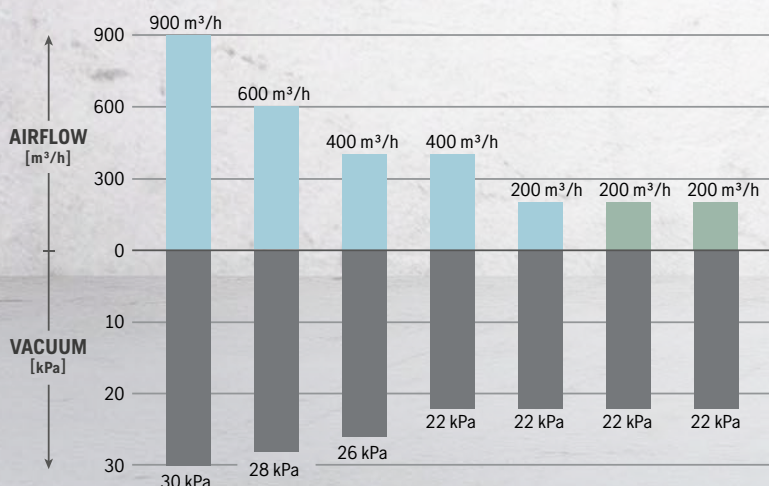

***NOTES TO WORK AREA**
Please note, Work area calculation based on a ceiling height of 2.5 m.
 At 6 air changes/h
 At 10 air changes/h



RECOMMENDED WORK METHODS FOR SAFER AND MORE EFFICIENT DUST CONTROL

One of the best ways to control dust is by using water. If possible, use enough water while wet cutting/drilling to bind the dust directly at the source. To keep the workplace clean, a slurry collector can be attached to a slurry vac.

If using water is not an option on the site, the cutting/drilling/grinding equipment should be used with an integrated dust collection device or tight-fitting dust shroud that captures dust directly at the source. This device should be connected to a dust extractor with the appropriate airflow and capacity for the application, and be equipped with HEPA H13 filters.

When cleaning the work area, use a scraper instead of a broom to clean the floor. Always use a dust extractor equipped with HEPA H13 filters when

vacuum-cleaning. NOTE: Standard/household vacuum cleaners are not able to catch respirable dust particles and should not be used for this purpose.

As a complement, using one or more portable air cleaners/scrubbers, equipped with efficient HEPA H13 filters, is an easy way to further reduce the level of respirable dust in the air, providing additional protection for all workers in the surrounding area. For sufficient protection from intense or long-term dust exposure, the operator should also wear an air-purifying respirator.

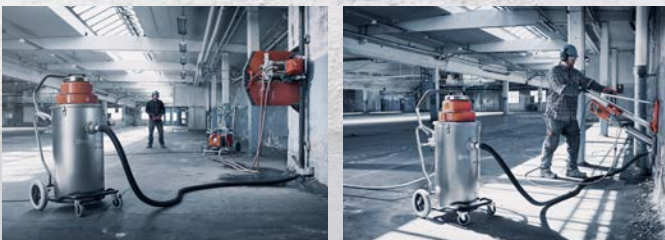

Wet cutting/drilling binds the dust with water directly at the source. The slurry collector connected to a slurry vac keeps the workplace clean.

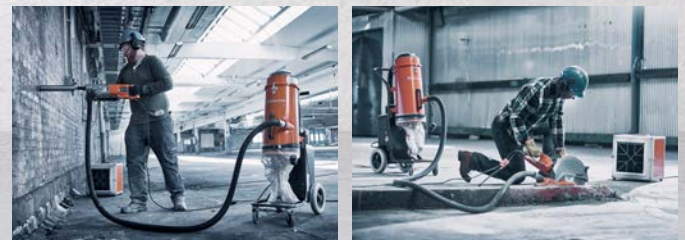

Dry cutting/drilling with an integrated dust collection device captures dust directly at the source. A dust extractor with the appropriate airflow and capacity for the application, also equipped with HEPA filters, takes care of the dust. The surrounding air is filtered through a portable air cleaner/scrubber 6–10 times/hour.



	T10000	T7500	DC 6000
TECHNICAL SPECIFICATIONS			
Power, kW	11	5.5	5.75
Voltage, V	380–415	380–415	380–480
Max rated current, A	32	16	16
Auxiliary outlet, W	N/A	N/A	Yes
Power supply	3-phase	3-phase	3-phase
Airflow, m ³ /h	900	600	700
Max vacuum, kPa	30	28	–
Suction inlet diameter, mm	76	76	76
Primary filter surface area, m ²	3.9	2.9	3
HEPA H13 filter surface area, m ²	7.5	5	7.8
Number of HEPA H13 filters	3	2	1
Classification	–	H	–
Dimensions (L × W × H), mm	1,400 × 736 × 1,727	1,245 × 686 × 1,753	1,252 × 766 × 1,899
Weight, kg	336	206	305
RECOMMENDED EQUIPMENT			
	PG 820 RC, PG 820, PG 680 RC, PG 680, PG 530	PG 820 RC, PG 820, PG 680 RC, PG 680, PG 530	PG 820 RC, PG 820, PG 680, PG 680 RC, PG 530
ARTICLE INFORMATION			
	967 66 37–04. Supplied with: One 76 mm hose (10 m) Camlock adapter 76–50 mm One 50 mm hose (7.5 m) Wand 50 mm. Floor tool 50 mm, 450 mm wide. One Longopac® bag.	967 66 41–04. Supplied with: One 76 mm hose (10 m) Camlock adapter 76–50 mm One 50 mm hose (7.5 m) Wand 50 mm. Floor tool 50 mm, 450 mm wide. One Longopac® bag.	967 62 50–01 Supplied with: One 75 mm hose (10 m) One 50 mm hose (10 m) Vacuum wand Floor tool. Two Longopac® bags.
RRP EXC VAT	£ 14,154.43	£ 10,128.85	£ 12,694.27

NOTE: Every single HEPA filter is individually tested and certified at filtration rate 99.99% at 0.3 microns.



	W70 P	W70
TECHNICAL SPECIFICATIONS		
Power, kW	1.2	1.2
Voltage, V	230/110	230/110
Max rated current, A	8/10	5/10
Power supply	1-phase	1-phase
Airflow, m ³ /h	200	200
Max vacuum, kPa	22	22
Suction inlet diameter, mm	51	51
Pump power, kW	0.65	–
Pump discharge, liter/min	260	–
Container capacity, liter	70	70
Dimensions (L×W×H), mm	600×570×1,250	600×570×1,250
Weight, kg	44	34
RECOMMENDED EQUIPMENT		
	Wall and wire saws, floor saws, core drill motors, power cutters, masonry and tile saws	Core drill motors, power cutters, masonry and tile saws
ARTICLE INFORMATION		
	967 66 47–04, 230 V. Supplied with 1 hose, 38 mm (3 m), 1 wand, 38 mm, 1 floor tool, 38 mm, 370 mm wide and one disposable wet bag.	967 70 20–02. Supplied with 1 hose, 38 mm (3 m), 1 wand, 38 mm, 1 floor tool, 38 mm, 370 mm wide.
	967 66 47–06, 110 V. Supplied with 1 hose, 38 mm (3 m), 1 wand, 38 mm, 1 floor tool, 38 mm, 370 mm wide and one disposable wet bag.	967 70 20–04, 110 V. Supplied with 1 hose, 38 mm (3 m), 1 wand, 38 mm, 1 floor tool, 38 mm, 370 mm wide.
RRP EXC VAT	110 V – £ 2,364.65 230 V – £ 2,453.88	110 V – £ 1,519.99 230 V – £ 1,669.00

SYSTEMS GUIDE



DRY APPLICATIONS	T 10000	T 7500	T 4000	DC 6000	C 5500	C 3000
FLOOR GRINDING, SCARIFYING AND POLISHING						
PG 820/PG 820 RC	✓	✓		✓	✓	
PG 680/PG 680 RC	✓	✓		✓	✓	
PG 530	✓	✓	✓	✓	✓	✓
PG 450			✓			✓
PG 400		✓	✓			✓
PG 280						✓
CG 200						✓
DRY CORE DRILLING						
DM 340						
DM 280						
DM 230						
DM 220						
DRY POWER CUTTING						
K 3000 / K 4000						
K 770 VAC						
OTHER APPLICATIONS						
115–125 mm angle grinder						
150–230 mm angle grinder						
100–125 mm hand grinder						
150–180 mm hand grinder						
Drills						
Hammers						

✓ Attached to machine + Part of solution

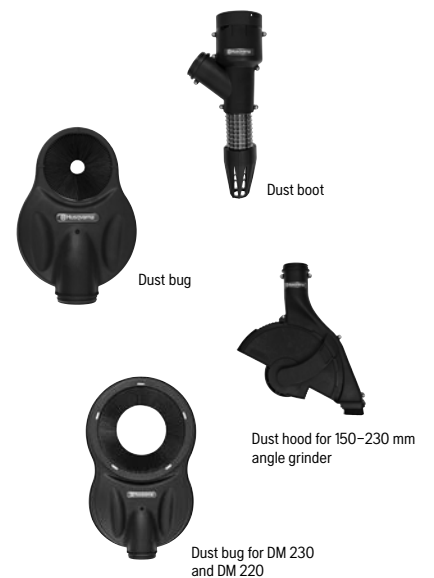



S 26	S 13	A 2000	A 1000
		+	
		+	
		+	
✓			+
✓			+
		+	
Dust bug ✓			
Dust bug ✓			
	Dust bug ✓		
	Vac attachment ✓		
✓			
	Dust hood ✓		
Dust hood ✓			
	Dust shroud ✓		
Dust shroud ✓			
Dust boot ✓			
Dust boot ✓			

WET APPLICATIONS	W 70 P	W 70	WATER SUPPLY
------------------	--------	------	--------------

WALL SAWING

WS 482 HF	Slurry collector ✓		
WS 440 HF	Slurry collector ✓		
WS 220	Slurry collector ✓		

WIRE SAWING

CS 2512	+		
CS 10	+		

FLOOR SAWING

FS 7000 D/DL	+		✓ Water pump kit
FS 5000 D	+		✓ Water pump kit
FS 4800 D	+		✓ Water pump kit
FS 3500 G	+		✓ Water pump kit
FS 500 series	+		✓ Water tank kit
FS 400 series	+		✓ Water tank kit
FS 300 series	+		✓ Water tank kit

WET CORE DRILLING

DM 650	Slurry ring ✓	Slurry ring ✓	
DM 340	Slurry ring ✓	Slurry ring ✓	
DM 280	Slurry ring ✓	Slurry ring ✓	
DM 230	Slurry ring ✓	Slurry ring ✓	✓ WT 15 / PWT
DM 220	Slurry ring ✓	Slurry ring ✓	✓ WT 15 / PWT

WET POWER CUTTING

K 770	+	+	✓ WT 15 / PWT / KV 7
K 970	+	+	✓ WT 15 / PWT / KV 9 / 12
K 1270	+	+	✓ WT 15 / PWT / KV 9 / 12
K 3000 / K 4000	+	+	✓ WT 15 / PWT
K 6500	+	+	✓ WT 15 / PWT

WET TILE AND MASONRY SAWING

TS 400 F	+	+	
TS 350 E	+	+	
TS 300 E	+	+	
TS 100 R	+	+	
TS 73 R	+	+	
TS 66 R	+	+	
TS 60	+	+	



Dust shroud for 150 – 230 mm angle grinder



Dust shroud for 115 – 125 mm angle grinder



Dust hood for 115 – 125 mm angle grinder



Slurry collector for wall sawing



Slurry ring

Slurry rings.

Explore our range of slurry rings and information on the right machine/ring combinations on page 115.



1 Longopac®



2 Pre-filter



3 HEPA-filter H13 T-Line



4 Vacuum hosing with end fittings



5 Hose complete for cleaning kit



6 Camlock adaptor female



7 Camlock adaptor male



8 Wand



9 Floor tool



10 Replacement rubber strips kit



11 Pre-separator Trailer



12 Pre-separator Trailer



13 Pre-filter

14 HEPA-filter H13



15 Adapter



16 Camlock female



17 HEPA 13 filter



18 Hosing with end fittings



19 Floor tool with vacuum wand



20 Replacement strap



21 Plastic adapter



22 Replacement brush kit



23 Black 75 mm ring



24 Dust shroud



26 Dust hood



27 Dust bug

25 Dust hood



28 Dust bug



29 Dust boot



30 Vac Kit attachment



31 Dust shroud



32 Dust shroud

Husqvarna T 10000.

ACCESSORIES AND SPARE PARTS		RRP EXC VAT
1	Bag Longopac®, 4 pcs	590 42 92-01 £ 95.00
2	Pre-filter, sock assy T 10000	590 43 86-01 £ 1,022.60
3	HEPA-filter H13 T-Line	590 42 97-01 £ 237.48
4	Hose complete 76 mm 10 m	590 43 70-01 £ 476.02
5	Hose 50 mm/7.5 m hose complete for cleaning kit	590 42 81-01 £ 145.31
6	Camlock adaptor female 76 mm – 50 mm (i.e. for T-Line cleaning kit)	590 43 65-01 £ 85.00
7	Camlock adaptor male 76 mm – 50 mm (i.e. for cleaning kit to 76 mm hose)	591 96 21-01 £ 72.00
8	Wand 50 mm	590 82 94-01 £ 53.06
9	Floor tool 450 mm rubber 50 mm	590 42 83-02 £ 62.45
10	Tool rubber blade set 450 mm	590 42 85-02 £ 8.28
11	Pre-separator Trailer T 10000, C 5500	590 43 33-01 £ 586.36
	Extension Camlock adaptor male 76 mm – male 76 mm	591 96 17-01 £ 129.00

Husqvarna T 7500.

ACCESSORIES AND SPARE PARTS		RRP EXC VAT
1	Bag Longopac®, 4 pcs	590 42 92-01 £ 95.00
2	Pre-filter, sock assy T 7500	590 43 88-01 £ 938.27
3	HEPA-filter H13 T-Line	590 42 97-01 £ 237.48
4	Hose complete 76 mm 10 m	590 43 70-01 £ 476.02
5	Hose 50 mm/7.5 m hose complete for cleaning kit	590 42 81-01 £ 145.31
6	Camlock adaptor female 76 mm – 50 mm (i.e. for T-Line cleaning kit)	590 43 65-01 £ 85.00
7	Camlock adaptor male 76 mm – 50 mm (i.e. for cleaning kit to 76 mm hose)	591 96 21-01 £ 72.00
8	Wand 50 mm	590 82 94-01 £ 53.06
9	Floor tool 450 mm rubber 50 mm	590 42 83-02 £ 62.45
10	Tool rubber blade set 450 mm	590 42 85-02 £ 8.28
12	Pre-separator Trailer T 7500, C 5500	590 43 33-02 £ 591.34
	Extension Camlock adaptor male 76 mm – male 76 mm	591 96 17-01 £ 129.00

Husqvarna T 4000.

ACCESSORIES AND SPARE PARTS		RRP EXC VAT
1	Bag Longopac®, 4 pcs	590 42 92-01 £ 95.00
5	Hose 50 mm/7.5 m hose complete	590 43 73-01 £ 108.29
8	Wand 50 mm	590 82 94-01 £ 53.06
9	Floor tool 450 mm rubber 50 mm	590 42 83-02 £ 62.45
10	Tool rubber blade set 450 mm	590 42 85-02 £ 8.28
13	Pre-filter, T 4000	590 43 02-02 £ 211.81
14	HEPA-filter H13 S-Line	590 42 98-01 £ 51.35
15	Adapter, 63 mm hose to 76 mm straight	590 42 94-01 £ 14.62
16	Camlock female to 76 mm	590 42 87-01 £ 34.04
16	Adapter 76 mm Camlock to 50 mm straight	590 43 65-01 £ 85.00
	Hose complete 63 mm 10 m (S36, T 4000)	590 43 74-01 £ 329.44

Husqvarna DC 6000.

ACCESSORIES AND SPARE PARTS		RRP EXC VAT
1	Bag Longopac®, DC 6000	584 65 02-01 £ 50.73
4	75 mm vacuum hosing with end fittings (10 m)	525 58 46-01 £ 810.75
10	Replacement rubber strips kit	521 91 21-01 £ 28.94
17	HEPA 13 filter	579 75 88-01 £ 644.93
18	50 mm vacuum hosing with end fittings (10 m)	585 87 10-01 £ 425.64
19	Floor tool with vacuum wand	585 87 09-01 £ 207.88
20	Replacement strap	584 61 87-01 £ 5.53
21	Plastic adapter	585 64 76-01 £ 13.16
22	Replacement brush kit	510 27 85-01 £ 23.46
23	Black 75 mm ring	502 53 40-05 £ 5.71

Husqvarna S 26.

ACCESSORIES AND SPARE PARTS		RRP	EXC VAT
1	Bag Longopac®, 4 pcs	590 42 92-01	£ 95.00
5	Hose 50 mm/7.5 m hose complete	590 43 73-01	£ 108.29
8	Wand 50 mm	590 82 94-01	£ 53.06
9	Floor tool 450 mm rubber 50 mm	590 42 83-02	£ 62.45
10	Tool rubber blade set 450 mm	590 42 85-02	£ 8.28
13	Pre-filter, S26	590 43 02-01	£ 101.23
14	HEPA-filter H13 S-Line	590 42 98-01	£ 75.00
24	Dust shroud 125 mm M14	593 01 04-01	£ 134.76
24	Dust shroud 180 mm	593 01 04-03	£ 148.60
25	Dust hood 102-125 mm	593 80 07-01	£ 85.00
26	Dust hood 180-230 mm	593 80 07-02	£ 107.17
27	Dust bug 90 mm	593 05 54-01	£ 78.57
28	Dust bug 180 mm	593 05 54-02	£ 130.76
29	Dust boot	593 80 30-01	£ 159.00
30	Vac Kit Attachment K 4000	523 09 50-01	£ 76.17
	Multi adaptor 50 mm hose	594 95 68-01	£ 13.95

Husqvarna S 13.

ACCESSORIES AND SPARE PARTS		RRP	EXC VAT
1	Bag Longopac®, 4 pcs	590 42 92-01	£ 95.00
5	Hose 38 mm/4 m hose complete	590 43 72-01	£ 94.75
8	Wand 38 mm	590 42 86-01	£ 31.26
10	Tool rubber blade set 370 mm	590 42 85-01	£ 11.17
13	Pre-filter, S 13	590 39 74-01	£ 69.00
14	HEPA-filter H13 S-Line	590 42 98-01	£ 75.00
25	Dust hood 102-125 mm	593 80 07-01	£ 85.00
27	Dust bug 90 mm	593 05 54-01	£ 78.57
30	Vac Kit Attachment K 4000	523 09 50-01	£ 76.17
31	Dust shroud 125 mm M 14	593 01 04-01	£ 134.76
	Floor tool 370 mm rubber 38 mm	591 99 27-01	£ 66.44
	Multi adapter 38 mm hose	594 95 69-01	£ 22.99

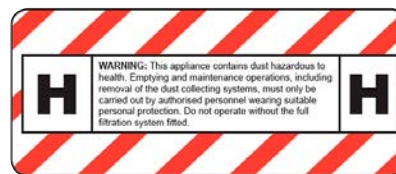

What is an H-classified dust extractor?

The international standard for testing wet and dry extractors, dust extractors (IEC-60335-2-69, EN-60335-2-69), are classified into three categories – L for low, M for medium and H for high – where the H category is the most stringent, not to be confused with the “H” in HEPA H13. Husqvarna S 26, S 36 and T 7500 are H-classified.

What is a Hepa H13 filter?

HEPA is an acronym for High Efficiency Particulate Air filters. The strict HEPA standard (EN 1822-1) is divided into different levels (E10 to H14) depending on filtration efficiency. Husqvarna applies level H13, which is designed to separate up to 99.95% of the particles between 0.15 and 0.30 µm in size. This particle size is the hardest to separate – both larger and smaller particles are easier to capture in a filter. In addition, Husqvarna tests each filter individually before delivery to approve that the filter really fulfils the HEPA H13 standard.

For more information, visit www.husqvarnacp.co.uk

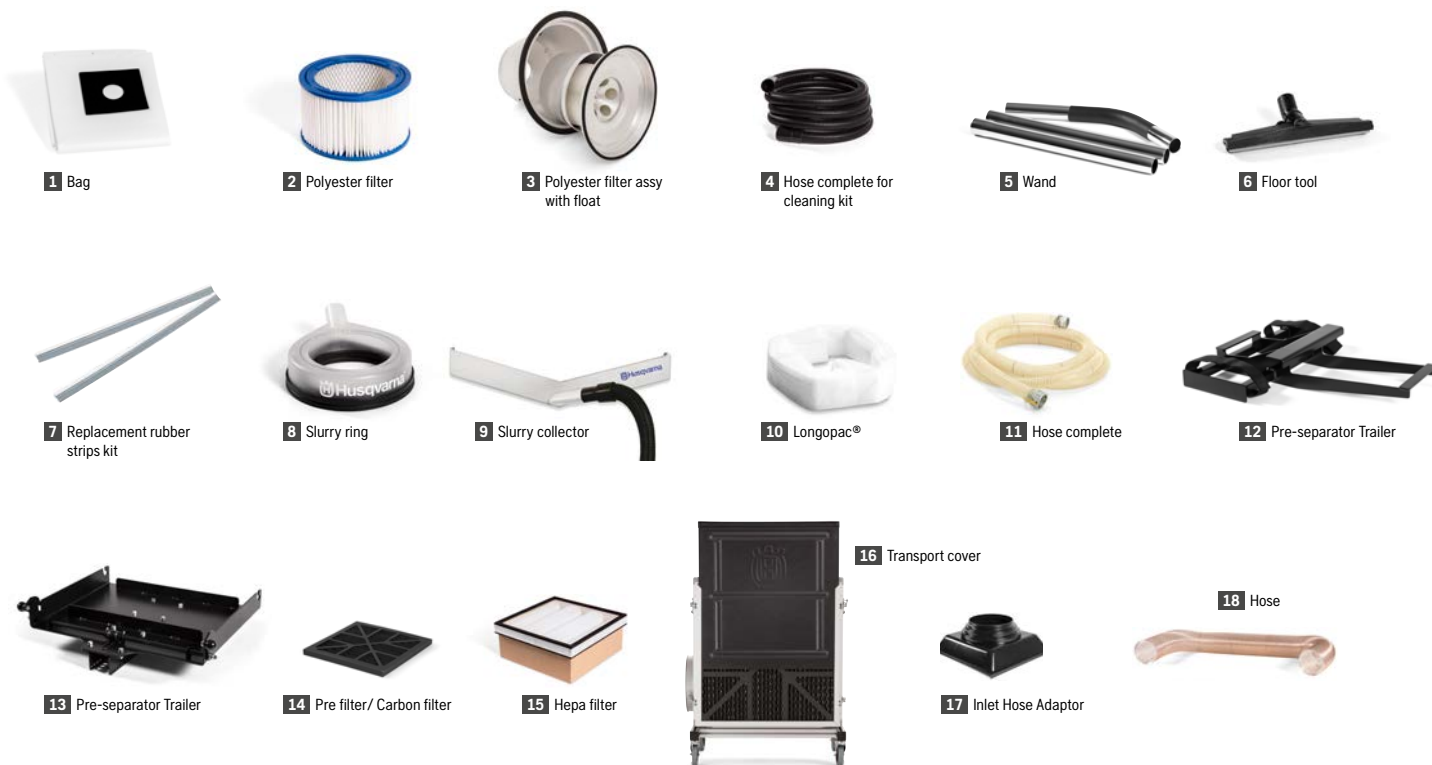

Husqvarna W 70 P.

ACCESSORIES AND SPARE PARTS		RRP	EXC VAT
1	Wet bag W 250 P, multi-layer, TH 55 W/5, order per piece in multiple 5	594 93 27-01	£ 41.92
1	Dry bag for W 250 P, multi-layer, TH 55, order per piece in multiple 5	595 00 18-01	£ 40.48
2	Polyester filter W 70, W 70 P	590 43 89-01	£ 53.90
3	Polyester filter assy with float W 70, W 70 P	590 46 93-01	£ 356.00
4	Hose complete 38 mm 3 m (W 250 P, W 70, W 70 P)	590 42 79-01	£ 38.89
5	Wand 38 mm	590 42 86-01	£ 31.26
6	Floor tool 370 mm rubber 38 mm	591 99 27-01	£ 66.44
7	Tool rubber blade set 370 mm	590 42 85-01	£ 11.17
8	Slurry rings WSR 100 mm	593 56 30-01	£ 155.00
8	Slurry rings WSR 150 mm	593 56 30-02	£ 165.00
8	Slurry rings WSR 200 mm	593 56 30-03	£ 215.00
8	Slurry rings WSR 250 mm	593 56 30-04	£ 229.00
8	Slurry rings WSR 300 mm	593 56 30-05	£ 322.00
8	Slurry rings WSR 350 mm	593 56 30-06	£ 359.00
9	Slurry collector V-shaped 350 mm	531 07 46-22	£ 98.40
9	Slurry collector V-shaped 700 mm	531 28 00-07	£ 162.38

Husqvarna W 70.

ACCESSORIES AND SPARE PARTS		RRP	EXC VAT
2	Polyester filter W 70, W 70 P	590 43 89-01	£ 53.90
3	Polyester filter assy with float W 70, W 70 P	590 46 93-01	£ 356.00
4	Hose complete 38 mm 3 m (W 250 P, W 70, W 70 P)	590 42 79-01	£ 38.89
5	Wand 38 mm	590 42 86-01	£ 31.26
6	Floor tool 370 mm rubber 38 mm	591 99 27-01	£ 66.44
7	Tool rubber blade set 370 mm	590 42 85-01	£ 11.17
8	Slurry rings WSR 100 mm	593 56 30-01	£ 155.00
8	Slurry rings WSR 150 mm	593 56 30-02	£ 165.00
8	Slurry rings WSR 200 mm	593 56 30-03	£ 215.00
8	Slurry rings WSR 250 mm	593 56 30-04	£ 229.00
8	Slurry rings WSR 300 mm	593 56 30-05	£ 322.00
8	Slurry rings WSR 350 mm	593 56 30-06	£ 359.00
9	Slurry collector V-shaped 350 mm	531 07 46-22	£ 98.40
9	Slurry collector V-shaped 700 mm	531 28 00-07	£ 162.38

Husqvarna C 5500.

ACCESSORIES AND SPARE PARTS		RRP	EXC VAT
10	Bag Longopac®, 4 pcs	590 42 92-01	£ 95.00
11	Hose complete, 76 mm 10 m	590 43 70-01	£ 476.02
12	Pre-separator trailer T 7500, C 5500	590 43 33-02	£ 591.34
13	Pre-separator trailer T 10000, C 5500	590 43 33-01	£ 586.36
	Hose complete, 63 mm 10 m	590 43 74-01	£ 329.44

Husqvarna C 3000.

ACCESSORIES AND SPARE PARTS		RRP	EXC VAT
10	Bag Longopac®, 4 pcs	590 42 92-01	£ 95.00
12	Pre-separator trailer S 26, C 3000	590 43 33-04	£ 491.92
12	Pre-separator trailer S 36 / T 4000, C 3000	590 43 33-03	£ 531.64
	Hose complete, 63 mm 10 m	590 43 74-01	£ 329.44

Husqvarna A 2000.

ACCESSORIES AND SPARE PARTS		RRP	EXC VAT
14	Pre filter A 2000 (20 pack)	590 43 00-02	£ 204.71
14	Carbon filter A 2000	591 99 40-01	£ 57.04
15	Hepa filter A 2000	590 42 77-01	£ 239.00
16	Transport cover A 2000	590 42 95-02	£ 48.48
17	Inlet Hose Adaptor A 2000	590 43 78-01	£ 66.55
18	Hose, A 2000 (254 mm × 6 m)	591 50 82-01	£ 329.00

Husqvarna A 1000.

ACCESSORIES AND SPARE PARTS		RRP	EXC VAT
14	Pre-filter A 1000 (20 pack)	590 43 00-01	£ 80.48
14	Carbon filter A 1000	591 99 41-01	£ 49.72
15	Hepa filter A 1000	590 46 08-01	£ 164.04
16	Transport cover A 1000	591 96 91-01	£ 22.13
17	Inlet Hose Adaptor A 1000	590 43 79-01	£ 44.30
18	Hose, A 1000 (160 mm × 6 m)	591 50 44-01	£ 219.00



HIGHLY VERSATILE WALL SAWING SYSTEMS DESIGNED TO INCREASE YOUR DAILY TURNOVER

A Husqvarna wall saw is ideal for all types of openings in almost all building materials, such as brick and reinforced concrete. In addition to their renowned power and durability, all Husqvarna wall sawing systems share a big advantage: they all have modular design with power units and saw units separated to make your job easier, allowing you to work faster. The saw units are very lightweight with outstanding power-to-weight ratio. Our electric, high frequency wall saws are operated with a wireless, ergonomic remote control that is very easy to manoeuvre, while also providing total control of the operation. Amongst the other smart solutions is the specially designed transport trolley, which helps you take everything you need conveniently around the jobsite.

Range overview.

Husqvarna offers one hydraulic and three high-frequency powered electric wall sawing systems, ranging from 395 mm to 730 mm cutting depth, with 6 kW to 20 kW spindle power and 19 kg to 28 kg saw head weight. For maximum productivity, choose the system/systems optimal for your kind of operation.

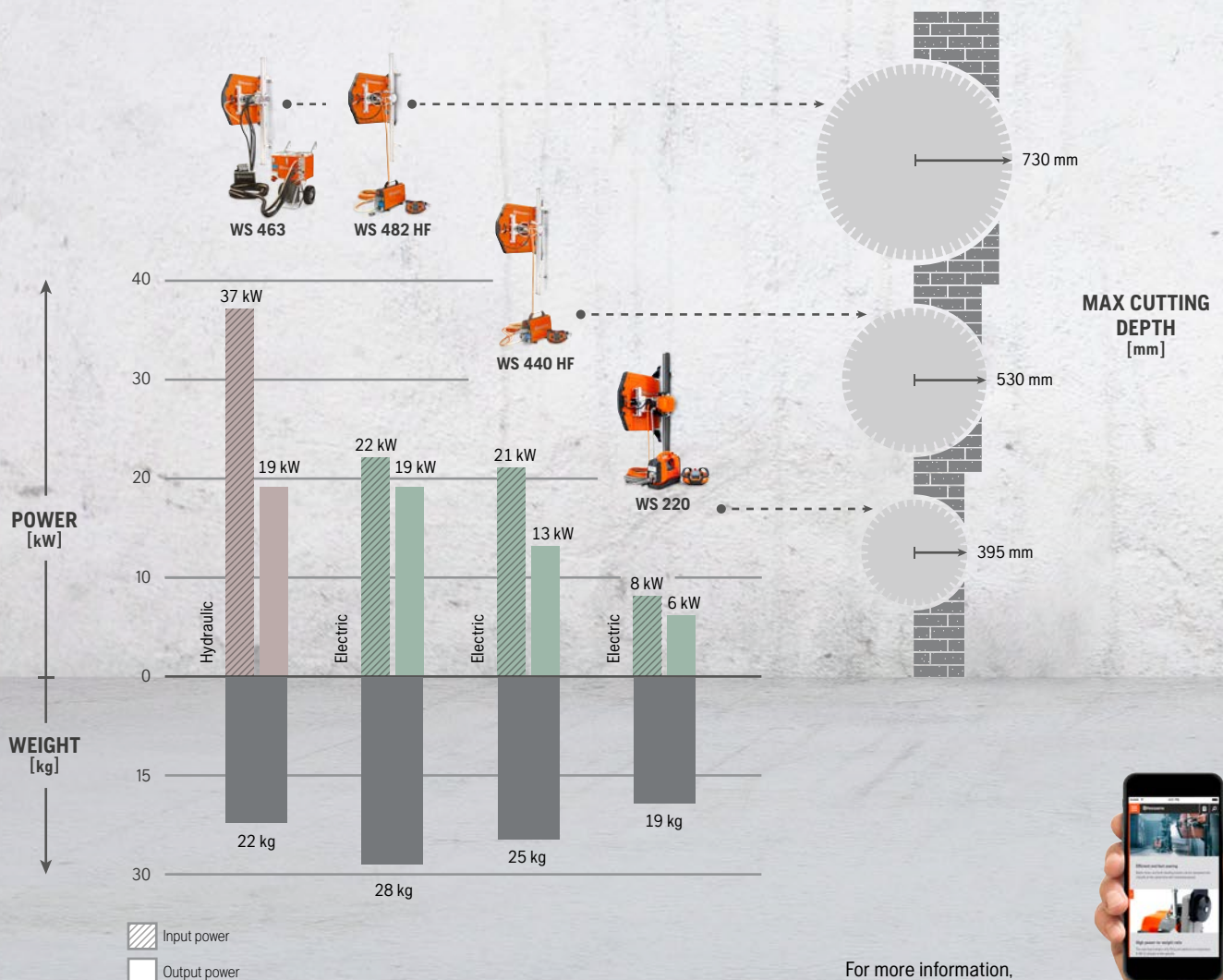

For more information, visit www.husqvarnacp.co.uk



HUSQVARNA PRIME™ PRODUCT RANGE

– LIGHT EQUIPMENT FOR HEAVY JOBS Our range of high-frequency PRIME™ equipment offers outstanding power-to-weight ratio and exceptional usability. Husqvarna WS 220 is compact and can handle most wall sawing jobs. You can also do drilling and handheld cutting using the same power source. In short, more jobs done with smaller and lighter equipment.

WIRELESS All Husqvarna wall saws are operated with a wireless remote control which is designed for an easy and comfortable operation.



FLEXIBLE POWER When you choose Husqvarna PP 490 as a power source for your large wall sawing systems, you can also use it to power your wire saw Husqvarna CS 10 or wall saw chain attachment Husqvarna WSC 40, as well as Husqvarna PRIME™ handheld power cutters and drill motor.

PRECISION Husqvarna WSC 40 wall saw chain attachment enables the user to cut neatly in and around corners without overcutting. Reaches into really tight spots and small openings.



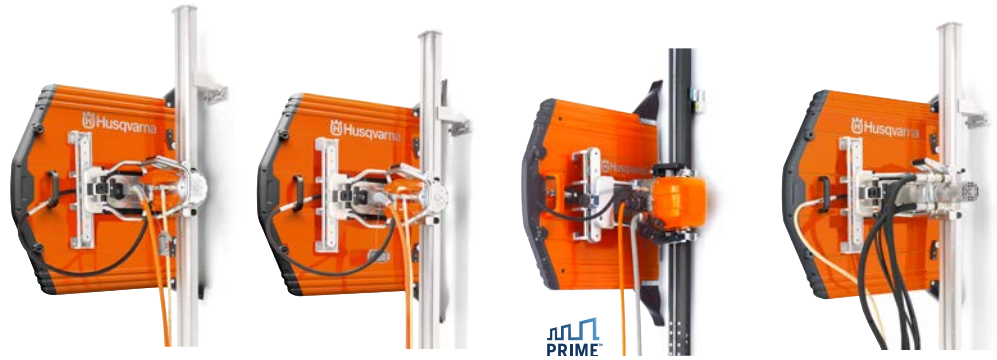

WALL SAWING SYSTEMS	WS 482 HF	WS 440 HF	WS 220	WS 463
TECHNICAL SPECIFICATIONS				
Min blade diameter, mm	600	600	500	600
Max starter blade, mm	1,000	1,000	600	1,000
Max blade diameter, mm	1,600	1,200	900	1,600
Max cutting depth, mm	730	530	395	730
Motor for saw blade	Electric	Electric	Electric	Hydraulic
Power input, kW	22	21	8	37
Max spindle output, kW	19	13	6	19
Output speed, rpm	0-950/0-1,200	0-1,200	0-1,150	630/1,000/1,400
Feeding system /control	Electric /Auto	Electric /Auto	Electric /Auto	Hydraulic /Auto
Weight saw head, kg	28	25	19	22
Long track, m/kg	2.0/18.5	2.0/18.5	2.16/11.0	2.0/18.5
Short track, m/kg	1.2/12.0	1.2/12.0	1.1/5.5	1.2/12.0
RECOMMENDED EQUIPMENT				
	PP 490, W 70 P	PP 440 HF, PP 490, W 70 P	PP 220, W 70 P	PP 455 E, W 70 P
ARTICLE INFORMATION				
	967 64 67-02, 380-400 V, 5 pin, 800 mm*	967 64 66-02, 400-480 V, 5 pin, 800 mm*	967 20 87-01, WS 220**	965 15 60-01, 800 mm***
	967 64 67-03, 380-400 V, 5 pin, 1000 mm*	967 64 66-03, 400-480 V, 5 pin, 1000 mm*		965 15 60-02, 1000 mm***
RRP EXC VAT	£ POA	£ POA	£ POA	£ POA

*Supplied with:
 4 wall mounting brackets
 Track coupling
 Oil
 Blade guard
 Track 1.2 m (Connectable)
 Track 2.0 m (Connectable)
 2 x saw carriage
 Tool kit
 Track holder
 Blade guard guide
 Remote control
 Power cable
 Water hoses
 Transport box containing charger
 CAN cable

**Supplied with:
 2 wall mounting brackets
 600 mm blade guard
 2 x 1.1 m connectable track sections
 Track connection joint
 Transport trolley
 Accessory box
 Remote control
 Power cable
 Water hoses
 Transport box with charger
 CAN cable

***Supplied with:
 4 wall mounting brackets
 Track coupling
 Oil
 Blade guard
 Track 1.2 m (Connectable)
 Track 2.0 m (Connectable)
 2 x saw carriage
 Tool kit
 Track holder
 Blade guard guide

APPLICATION OVERVIEW

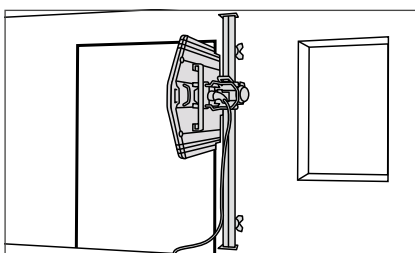

Door and window openings. The undercut is made by flush cutting.

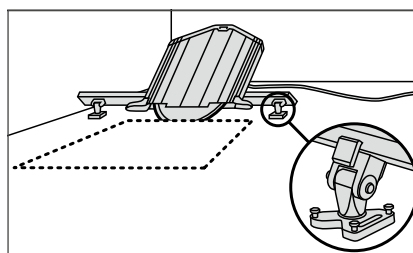

Bevel cutting. Our universal mounting enables you to make cuts at a steplessly adjustable angle.

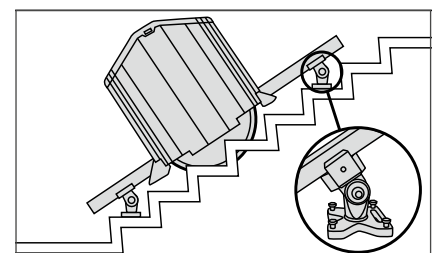

Sawing of steps or other uneven contours.



Husqvarna WSC 40 is a truly unique, heavy-duty attachment that converts your Husqvarna WS 482 HF and WS 440 HF from blade to chain sawing. Enables efficient and precise sawing of corners and small openings without overcutting. Installs easily on the spindle, and fits into the kerf without re-positioning the rail.



1 Reinforced handlebar, mandatory when running WSC 40

WALL SAW CHAIN ATTACHMENT	WSC 40
TECHNICAL SPECIFICATIONS	
Max cutting depth*, mm	400
Max straight cutting depth, mm	300
Weight, standard cutting, incl. bar, chain and guards, kg	19
RECOMMENDED EQUIPMENT	
	WS 482 HF, WS 440 HF
ARTICLE INFORMATION	
	967 25 23-01**
RRP EXC VAT	£ POA

* Display indicate max cutting depth 393-397mm. ** Supplied with: 2 standard guards, 2 flush cutting guards, tool kit and transport box.

ACCESSORIES	RRP EXC VAT
1 Reinforced handlebar kit (WS 482)	592 89 64-01 £ 214.90
1 Reinforced handlebar kit (WS 440)	592 89 63-01 £ 214.90

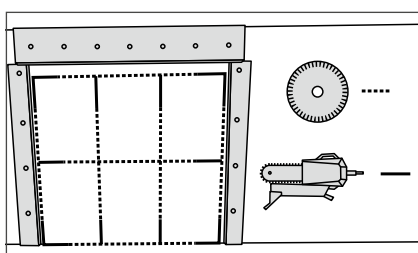

WSC 40 enables efficient and precise sawing of corners without overcutting.

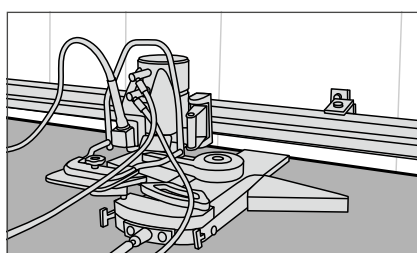

WSC 40 handles flush cutting in tight places, close to the floor, ceiling or wall.

**TAKE CARE OF CONCRETE
DUST AND SLURRY IN A SMART
EASY AND EFFICIENT WAY!**

SEE THE SYSTEMS GUIDE ON PAGE 68



1 Blade guard for WS 482 HF, WS 440 HF and WS 463



2 Blade guard for WS 220



3 Blade guard for flush cutting, for WS 482 HF, WS 440 HF and WS 463



4 Blade guard for flush cutting, for WS 220



5 Blade guard guide



6 Saw carriage



7 Blade flange hub



8 Harness for the remote control, worn over one shoulder



9 Mounting bracket, standard, for WS 482 HF, WS 440 HF and WS 463



10 Kit with 2 mounting brackets, universal and 1 template bracket, universal

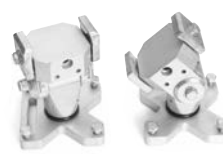

11 Mounting bracket, universal, for WS 482 HF, WS 440 HF and WS 463



12 Template bracket, universal



13 Track in 3 different lengths for WS 482 HF, WS 440 HF and WS 463



14 Track holder for easier track mounting for WS 482 HF, WS 440 HF and WS 463



15 Coupling link for joining tracks together for WS 482 HF, WS 440 HF and WS 463



16 Measure pin to mounting bracket, universal, for WS 482 HF, WS 440 HF and WS 463



17 Additional tracks for WS 220



18 Mounting bracket, universal for WS 220



19 Mounting bracket, standard, for WS 220



20 Anchors

Husqvarna WS 482 HF, WS 440 HF and WS 463.

ACCESSORIES		RRP	EXC VAT
1	Blade guard, 1600 mm (WS 482 HF, WS 463)	577 66 10-01	£ 4,499.43
1	Blade guard, 1200 mm	577 66 04-01	£ 3,487.07
1	Blade guard, 800 mm	577 65 97-01	£ 2,249.70
1	Blade guard, 1000 mm	577 66 01-01	£ 2,812.15
3	Blade guard for flush cutting, 800 mm	577 74 23-01	£ 2,024.72
3	Blade guard for flush cutting, 1000 mm	577 74 24-01	£ 2,530.93
3	Blade guard for flush cutting, 1200 mm	577 74 25-01	£ 3,037.11
3	Blade guard for flush cutting, 1600 mm (WS 482 HF, WS 463)	577 74 26-01	£ 4,049.49
5	Blade guard guide	580 67 77-01	£ 339.67
6	Saw carriage	584 64 21-01	£ 1,502.21
7	Blade flange hub, bore 130 mm	574 82 95-06	£ 1,293.00
7	Blade flange hub, bore 60 mm	574 82 95-05	£ 1,181.73
8	Harness (WS 482 HF and WS 440 HF)	510 28 00-01	£ 689.54
9	Mounting bracket, standard	531 11 32-46	£ 191.20
11	Mounting bracket, universal	531 11 32-00	£ 292.23
12	Template bracket, universal	505 23 12-01	£ 175.52
13	Track, 1.2 m	531 11 30-45	£ 640.19
13	Track, 2.0 m	531 11 30-46	£ 961.02
13	Track, 2.2 m	531 11 30-47	£ 1,057.08
14	Track holder	531 11 32-48	£ 48.85
15	Coupling link	531 11 32-47	£ 87.05
16	Measure pin to universal bracket	531 11 32-65	£ 41.11
20	Anchors, 50 pcs (M12)	502 43 54-01	£ 42.96
21	Water hose, saw head to blade flange	505 21 84-01	£ 65.34
23	Tool kit	501 37 52-01	£ 292.44
24	Cleaning brush	531 11 32-68	£ 18.69
25	Gardena-Tema water adapter	585 56 41-01	£ 37.73
28	Transport trolley	590 87 63-01	£ POA
	Box for remote control (WS 482 HF, WS 440 HF)	587 18 97-01	£ 111.16

EQUIPMENT FOR WIRE SAWING

30	CS 10	966 56 57-01	£ 12,206.04
----	-------	--------------	-------------



21 Water hose, saw head to blade flange for WS 482 HF, WS 440 HF and WS 463



22 Water hose, saw head to blade flange for WS 220



23 Tool kit, complete set of wrenches, allen keys and sockets



24 Cleaning brush



25 Gardena-Tema water adapter



26 Connection joint for WS 220



27 Excentric bolt for WS 220

Husqvarna WS 220.

ACCESSORIES		RRP	EXC VAT
2	Blade guard, 600 mm	579 10 45-01	£ 1,687.28
2	Blade guard, 900 mm	579 10 46-01	£ 2,530.93
4	Blade guard for flush cutting, 600 mm	579 10 47-01	£ 1,518.57
4	Blade guard for flush cutting, 900 mm	579 10 48-01	£ 2,277.82
5	Blade guard guide	579 10 41-01	£ 432.63
8	Harness	510 28 00-01	£ 689.54
10	Kit with 2 mounting brackets, universal and 1 template bracket, universal	501 94 69-01	£ 1,528.22
12	Template bracket, universal	501 59 81-01	£ 115.92
15	Connection joint	583 96 55-01	£ 54.56
17	Track, 1.1 m	587 92 58-03	£ 749.00
17	Track with fixed stop, 1.1 m	588 98 42-01	£ 763.20
18	Mounting bracket, universal	587 01 35-01	£ 879.19
19	Mounting bracket, standard	583 96 57-01	£ 412.28
20	Anchors, 50 pcs (M10)	584 40 94-02	£ POA
22	Water hose, saw head to blade flange	585 60 69-01	£ 47.64
24	Cleaning brush	531 11 32-68	£ 18.69
25	Gardena-Tema water adapter	585 56 41-01	£ 37.73
27	Excentric bolt	575 32 04-01	£ 12.99
29	Transport trolley	579 10 49-03	£ POA
	Blade guard for twin blades, 600 mm*	577 87 74-01	£ 1,896.54
	Box for remote control	587 18 97-01	£ 111.16
	Toolbox	586 45 31-01	£ POA

*max total distance between blades is 50 mm (washer not included)



28 Transport trolley for WS 400 series



29 Transport trolley for WS 220



30 Your wall saw can be combined with the CS 10, transforming it into a perfect wire saw



POWER PACKS	PP 490	PP 440 HF	PP 220	PP 455 E
TECHNICAL SPECIFICATIONS				
Power input, kW	22	21	8	37
Power output, kW	20	15	6.5	25
Rated current, A	32/25/16 reduced	32/25/16 reduced	16/16 (3-phase/1-phase)	63/32 reduced
Voltage, V	400	400	180-400	400
Pressure, bar	—	—	—	230
Flow, l/min	—	—	—	65
Weight, kg	25	18	10	139 (including oil)
RECOMMENDED EQUIPMENT				
	WS 482 HF, WS 440 HF, CS 10 (together with WS 482 HF or WS 440 HF) K 6500, K 6500 Ring, K 6500 Chain, DM 650	WS 440 HF, CS 10 (together with WS 440 HF)	WS 220, K 6500, K 6500 Ring, K 6500 Chain, DM 650	WS 463, CS 2512
ARTICLE INFORMATION				
	967 64 98-01, PP 490, 380-400 V, 5 pin	967 64 97-03, PP 440 HF, 380-480 V, 5 pin	966 56 38-01, incl adapter cable for 1-phase	965 15 66-02, 400 V, 4 pin, with radio*
RRP EXC VAT	£ POA	£ POA	£ POA	£ POA

*Supplied with:
 Remote control incl. CAN cable (6 m)
 Recharging adapter (12 V/230 V)
 Bag for remote control and accessories
 Hose package (8 m)

	WALL SAWING			WIRE SAWING	HANDHELD POWER CUTTING - PRIME™ PRODUCT RANGE			DRILLING - PRIME™ PRODUCT
	WS 482 HF	WS 440 HF	WS 220	CS 10	K 6500	K 6500 RING	K 6500 CHAIN	DM 650
PP 490	●	●	—	With WS 482 HF or WS 440 HF	●	●	●	●
PP 440 HF	—	●	—	With WS 440 HF	—	—	—	—
PP 220	—	—	●	—	●	●	●	●



The modular design, lightweight saw units and specially designed trolleys make Husqvarna wall sawing systems easy for one person to transport and set up.



1 Remote control

2 Harness for the remote control
Worn over one shoulder

3 CAN cable

4 Water valve for flow control of water
to the blade for PP 490 and
PP 440 HF

5 Water hose for PP 490 and PP 440 HF

6 Power cable for connection to saws
for PP 490 and PP 440 HF7 Socket 32 A for PP 490 and
PP 440 HF

8 Power cable for PP 220



9 Power harness adapter for PP 220

10 Water valve for flow control of water
to the blade for PP 220

11 Gardena-Tema water adapter

12 External cooler, to be used where
the need for additional cooling is
increased13 Supplementary cooler, to be used
where the inlet water temperature is
higher than 25°C or the outlet water
flow from the machine is lower than
5 l/min

14 CAN cable for PP 455 E

15 Hose set including couplings for
PP 455 E

16 Hydraulic oil filter



17 Water hose connection for PP 455 E

Husqvarna PP 490 and PP 440 HF.

SPARE PARTS	RRP EXC VAT
1 Remote control incl. extra battery	578 28 48-02 £ 1,282.37
2 Harness	501 79 30-01 £ 498.92
3 CAN cable	577 05 99-02 £ 511.50
4 Water valve	505 42 42-01 £ 40.92
5 Water hose, 8 m	505 11 53-01 £ 29.53
6 Power cable, 8 m	591 47 98-02 £ 565.39
6 Power cable, 15 m	577 41 87-02 £ 1,471.58
7 Socket 32 A	531 11 71-31 £ 22.95
Remote control incl. extra battery, charger, power cable and CAN cable	587 11 35-01 £ 2,263.97

Husqvarna PP 220.

SPARE PARTS	RRP EXC VAT
3 CAN cable	577 05 99-02 £ 511.50
8 Power cable	578 37 23-01 £ 986.59
9 Power harness adapter	579 00 23-01 £ 67.79
10 Water valve	585 02 21-01 £ 12.87
11 Gardena-Tema water adapter	901 03 16-01 £ 36.38
Remote control incl. extra battery	587 11 35-01 £ 1,236.62
Remote control incl. extra battery, charger, power cable and CAN cable	587 11 35-01 £ 2,263.97

Husqvarna PP 455 E.

ACCESSORIES AND SPARE PARTS	RRP EXC VAT
12 External cooler	574 23 73-01 £ 1,783.65
13 Supplementary cooler	504 81 20-01 £ 99.19
14 CAN cable, 6 m	531 11 50-12 £ 311.20
15 Hose set incl. couplings, 8 m	531 11 51-90 £ 1,367.64
16 Hydraulic oil filter	531 11 81-42 £ 44.14
17 Water hose connection	510 20 30-01 £ 30.06

DIAMOND BLADES AND CHAIN FOR WALL SAWING

With their advanced design, Husqvarna's wall saw blades always ensure top performance in terms of product life and cutting properties. The W 1500 series is available with the revolutionary Diagrip™ technology, where the diamonds are specially treated to be distributed optimally and remain in place in the segments longer. Also available is a low-noise version with a three-layer sandwich core which produces 50 % less noise than a standard solid core. Husqvarna PRO 20 and PRO 45 for WSC 40 are diamond chains optimised for use with WSC 40, enabling efficient cutting and long service life with minimal chain stretch.

Revolutionary diamond tool technology for great cutting capacity and durability.

One of the greatest benefits with the Diagrip™ technology is how fast and smooth the diamond tools go through all types of construction materials. Diagrip™ tools means trouble-free sawing, especially in heavily reinforced concrete.

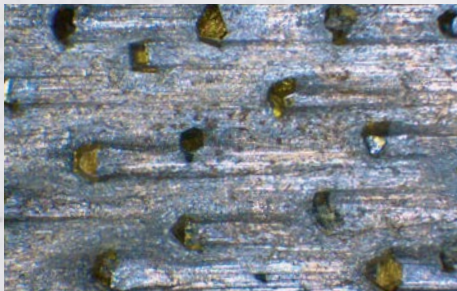

The diamonds are specially treated to remain in place in the segments longer, and be distributed optimally, delivering maximum efficiency to every diamond. With Diagrip™ the diamonds are exposed and expended at an even rate, which makes the edge very even and powerful, even when cutting hard materials like reinforced concrete.



W 1500 DIAGRIP™

- GOLD
- SILVER

See page 16 for more information.

MACHINE POWER	GOLD		
	5-10 KW	10-15 KW	15-20 KW
PRODUCT	W 1505 - NEW!	W 1510	W 1525
SEGMENT SHAPE			
MATERIAL			
Reinforced concrete, hard	●●●	●●●	●●●
Reinforced concrete, medium	●●●	●●●	●●●
Reinforced concrete, soft	●●	●●	●●●
Brick	●●	●●	●●
RECOMMENDED EQUIPMENT			
	WS 220	WS 440	WS 482

●●● = Optimal ●● = Good ● = Acceptable — = Not recommended



DIAMOND CHAINS

MACHINE POWER		
PRODUCT	PRO 20 WSC 40	PRO 45 WSC 40
MATERIAL		
Reinforced concrete, hard	●●●	●●
Reinforced concrete, medium	●●	●●●
Reinforced concrete, soft	●	●●●
Brick	●	●●
RECOMMENDED EQUIPMENT		
	WSC 40	WSC 40

●●● = Optimal ●● = Good ● = Acceptable — = Not recommended

Husqvarna W1505.

Gold level blades for hard concrete, 5–10 kW saws.

PRODUCT NUMBER – MULTI FLUSH CUTTING DRAWING PL3012 FOR WS 440 HF, WS 463, WS 482 HF	DIAMETER, MM	SEGMENT LENGTH, MM	SEGMENT WIDTH, MM	SEGMENT HEIGHT, MM	BORE, MM	RRP EXC VAT
STANDARD WALL SAW BLADES						
593 94 36-06	600	40	4.7	11+3	60	£ 631.25
593 94 40-03	700	40	4.7	11+3	60	£ 796.89
593 94 42-05	800	40	4.7	11+3	60	£ 994.85
593 94 45-04	900	40	4.7	11+3	60	£ 1,186.75
593 94 46-02	1,000	40	4.5	11+3	60	£ 631.25
593 94 47-02	1,200	40	4.5	11+3	60	£ 1,919.00
593 94 48-02	1,500	40	4.5	11+3	60	£ 3,438.04
593 94 49-02	1,600	40	4.5	11+3	60	£ 3,951.12
PRE-CUT BLADES						
593 94 36-07	600	40	5.0	11+3	60	£ 815.04
593 94 42-07	800	40	5.0	11+3	60	£ 1,004.13
593 94 46-04	1,000	40	4.7	11+3	60	£ 1,533.66
593 94 47-04	1,200	40	4.7	11+3	60	£ 1,919.00

PRODUCT NUMBER – FLUSH CUTTING DRAWING PL70061 FOR WS 220	DIAMETER, MM	SEGMENT LENGTH, MM	SEGMENT WIDTH, MM	SEGMENT HEIGHT, MM	BORE, MM	RRP EXC VAT
WALL SAW BLADES FOR WS 220, LOW POWER SAWS						
593 94 36-02	600	40	3.8	11+3	60	£ 631.25
593 94 45-02	900	40	3.8	11+3	60	£ 1,186.75
PRE-CUT BLADES						
593 94 36-04	600	40	4.2	11+3	60	£ 815.04

Husqvarna W1510.

Gold level blades for medium hard concrete, 10–15 kW saws.

PRODUCT NUMBER – MULTI FLUSH CUTTING DRAWING PL3012 FOR WS 440 HF, WS 463, WS 482 HF	DIAMETER, MM	SEGMENT LENGTH, MM	SEGMENT WIDTH, MM	SEGMENT HEIGHT, MM	BORE, MM	RRP EXC VAT
STANDARD WALL SAW BLADES						
592 74 91-02	600	40	4.7	11+3	60	£ 631.25
592 74 94-02	700	40	4.7	11+3	60	£ 796.89
591 35 65-02	800	40	4.7	11+3	60	£ 994.85
592 74 96-02	900	40	4.7	11+3	60	£ 1,186.75
592 74 97-02	1,000	40	4.5	11+3	60	£ 1,363.50
592 74 98-02	1,200	40	4.5	11+3	60	£ 1,919.00
592 74 99-02	1,500	40	4.5	11+3	60	£ 3,438.04
593 33 45-02	1,600	40	4.5	11+3	60	£ 3,951.12
PRE-CUT BLADES						
592 74 91-13	600	40	5.0	11+3	60	£ 815.04
591 35 65-11	800	40	5.0	11+3	60	£ 1,004.13
591 35 65-08	800	40	6.0	11+3	60	
592 74 97-06	1,000	40	4.7	11+3	60	£ 1,533.66
592 74 98-06	1,200	40	4.7	11+3	60	£ 2,007.52
LOW NOISE WALL SAW BLADES						
592 74 91-04	600	40	5.0	11+3	60	£ 889.00
592 74 94-04	700	40	5.0	11+3	60	£ 1,175.00
591 35 65-04	800	40	5.0	11+3	60	£ 1,269.00
592 74 96-04	900	40	5.0	11+3	60	£ 1,598.00
592 74 97-04	1,000	40	4.7	11+3	60	£ 1,749.00
592 74 98-04	1,200	40	4.7	11+3	60	£ 2,099.00



Husqvarna W 1525.

Gold level blades for medium to soft concrete, 15–20 kW saws.

PRODUCT NUMBER - 60 MM CENTRE HOLE	PRODUCT NUMBER - MULTI FLUSH CUTTING DRAWING PL3012 FOR WS 440 HF, WS 463, WS 482 HF	DIAMETER, MM	SEGMENT LENGTH, MM	SEGMENT WIDTH, MM	SEGMENT HEIGHT, MM	BORE, MM	RRP EXC VAT
STANDARD WALL SAW BLADES							
590 77 89-01	590 77 89-04	600	40	4.7	11+3	60	£ 631.25
590 77 90-01	590 77 90-03	700	40	4.7	11+3	60	£ 796.89
590 77 91-01	590 77 91-03	800	40	4.7	11+3	60	£ 994.85
590 77 92-01	590 77 92-03	900	40	4.7	11+3	60	£ 1,186.75
590 77 93-03	590 77 93-04	1,000	40	4.5	11+3	60	£ 1,363.50
590 77 94-03	590 77 94-04	1,200	40	4.5	11+3	60	£ 1,919.00
592 75 06-01	592 75 06-02	1,500	40	4.5	11+3	60	£ 3,438.04
593 06 93-01	593 06 93-02	1,600	40	4.5	11+3	60	£ 3,951.12
PRE-CUT BLADES							
590 67 81-02	590 67 81-03	600	40	5.0	11+3	60	£ 631.25
589 72 73-01	590 77 91-08	800	40	5.0	11+3	60	£ 994.85
590 77 93-01	590 77 93-07	1,000	40	4.7	11+3	60	£ 1,363.50
590 77 94-01	590 77 94-07	1,200	40	4.7	11+3	60	£ 1,919.00





Husqvarna PRO diamond chains for WSC 40.

Gold level diamond chain optimised for use with WSC 40, developed for sawing in reinforced concrete and other construction materials with different hardness.

PRODUCT NUMBER	CHAIN PITCH, INCH	CHAIN/BAR LENGTH, MM / INCH	NUMBER OF SEGMENTS	SEGMENT WIDTH, MM	RRP EXC VAT
PRO 20 WSC 40					
589 55 46-01	0.444"	400/16	37	5.7	£ 1,111.38
PRO 45 WSC 40					
588 15 04-03	0.444"	400/16	37	5.7	£ 1,111.38
GUIDE BAR		PRODUCT NUMBER	RRP EXC VAT		
400 mm/16" (0.444")		589 00 00-01	£ 1,200.00		
CHAIN ACCESSORY		PRODUCT NUMBER	RRP EXC VAT		
Chain segment and link repair kit (0.444")		588 10 68-11	£ POA		
Chain link repair kit (0.444")		588 10 68-12	£ POA		

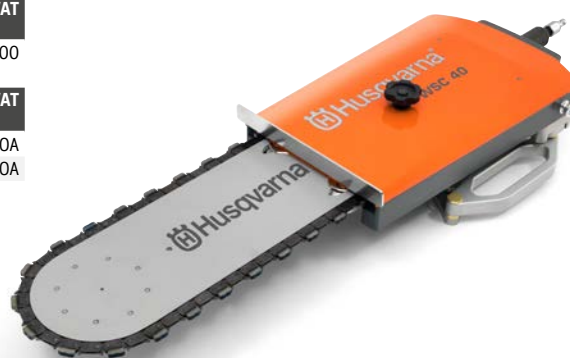

NO LIMITS IN SAWING DEPTH – OR IN BUSINESS POTENTIAL

Our premium quality wire sawing systems are ideally designed for high productivity. They are flexible, powerful and easy to use, which helps getting the job done quickly and profitable– but still with great results. Thanks to clever design that increases the friction between the wire and the drive wheel, your wire sawing becomes effortless and efficient. The modular pulley system can easily be adapted to a wide range of applications, so there is virtually no limit in terms of sawing depth or profile. Also our diamond wires enable you to cut very complex structures, both in steel and heavily reinforced concrete.

Range overview.

Husqvarna offers two wire sawing systems with different setups: Husqvarna CS 2512 is powered by an integrated hydraulic 20 kW motor, weighs 150 kg and has a 12 m wire magazine. Husqvarna CS 10 is powered by the high-frequency electric saw head of the WS 482 HF or WS 440 HF wall sawing system. It weighs 110 kg without saw head and has a 10 m wire magazine.

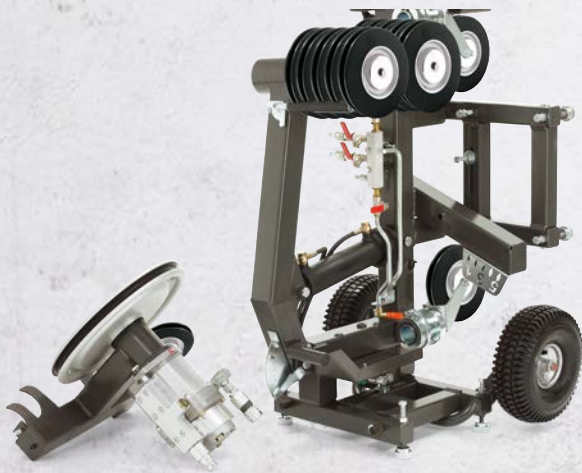

MODULAR CS 2512 is modular, so it is easy to install and handle. It can be positioned both vertically and horizontally. The motor can be detached for easier transport.

CAPACITY Husqvarna's CS 2512 wire saw has a large magazine capacity, so larger cuts can be made without cutting the wire.



ADJUSTABLE CS 2512 is equipped with swivel pulleys. This, combined with the ability to make both vertical and horizontal cuts, ensures superb flexibility.



TWO IN ONE Add a CS 10 to your Husqvarna WS 482 HF or WS 440 HF system and you will practically have two machines in one. An efficient investment that is flexible and easy to use, ideal also for smaller jobs.



DURABLE All Husqvarna diamond wires feature a special rubber bond. This provides increased lifetime through better adhesion to the core and beads, as well as higher resistance to UV radiation. The visibility during underwater cutting operations is also improved.

FLEXIBLE CS 10 can be run by WS 482 HF and WS 440 wall saws, forming a complete and flexible wire and wall cutting system. Suitable power packs is PP 490.

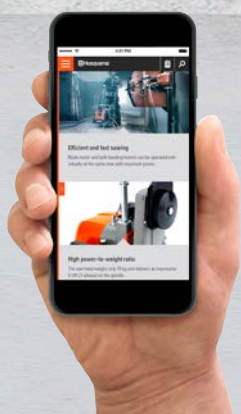

For more information, visit www.husqvarnacp.co.uk



Husqvarna
PP 455 E

Husqvarna CS 2512.

WIRE SAW	CS 2512
TECHNICAL SPECIFICATIONS	
Power kW	20
Motor for wire drive	Hydraulic multiple gear
Max drive torque at drive wheel, Nm	200
Starting torque, Nm	190
Feed system/control	Hydraulic / Auto
Wire speed, m/s	20 or 25
Magazine capacity, m	12 m
Wire length, m	15 m
Flow, l/min	65
Pressure, bar	230
Dimensions (L×W×H), mm	1,100×750×900
Weight, kg	150
RECOMMENDED EQUIPMENT	
	PP 455 E*, W 70 P
ARTICLE INFORMATION	
	965 15 62-01
	965 15 62-02, (incl. 15 m C 1000 wire)
RRP EXC VAT	£ POA £ POA



With CS 10 you can saw both vertically and horizontally. The saw head can be mounted on either side of the track and you can choose the wire's direction of rotation. All of this makes for highly flexible and efficient wire sawing.

* More information about PP 455 E on pages 80–81.

APPLICATION OVERVIEW

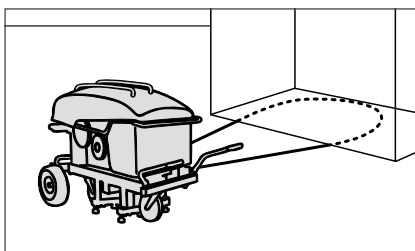

Wire sawing for large jobs such as foundations and bridges.

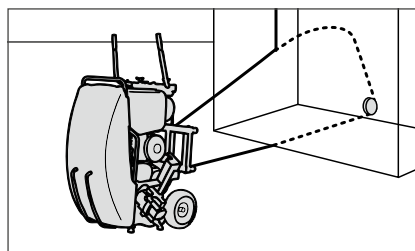

Cutting in thick walls and openings with exact corners.

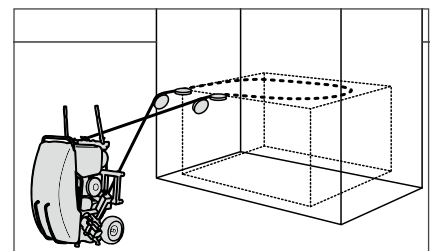

Deep wire sawing in confined spaces.

Husqvarna CS 10.

WIRE SAW	CS 10
TECHNICAL SPECIFICATIONS	
Output power with WS 482 HF and PP 490	19 kW
Speed	0-1,200 rpm
Wire speed at 1,200 rpm	24 m/s
Magazine capacity	10 m
Wire length, max/min	11.7/1.7 m
Column height	1,200 mm
Weight, WS 482 HF	138 kg
RECOMMENDED EQUIPMENT	
	WS 482 HF and PP 490* W 70 P
ARTICLE INFORMATION	
	966 56 57-01, 2 swivel pulleys version
RRP EXC VAT	£ POA

* More information about WS 482 HF and WS 440 HF on page 76. Can also be run with WS 440 HF and PP 440.

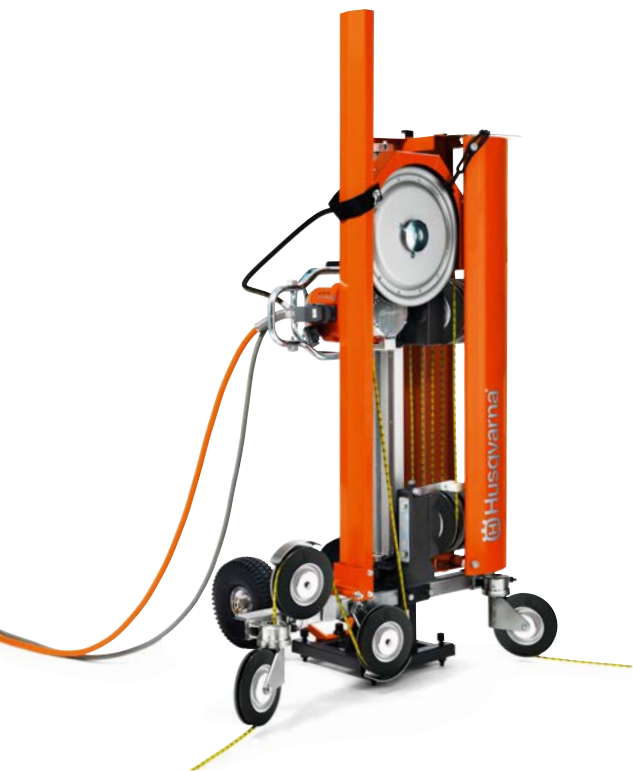

CS 10 can be combined with WS 482 HF wall saw, forming a complete wire and wall cutting system.

TAKE CARE OF CONCRETE DUST AND SLURRY IN A SMART EASY AND EFFICIENT WAY!

SEE THE SYSTEMS GUIDE ON PAGE 68

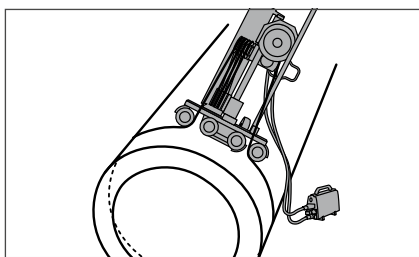

CS 10 has a flexible design and can easily be mounted on objects like pipes.

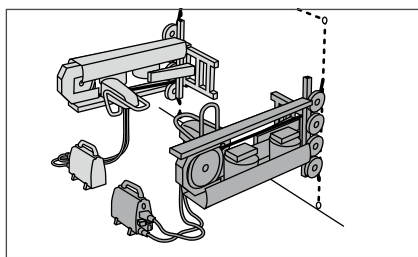

CS 10 can be installed to cut on the right or the left. This gives great flexibility during installation and in selecting the direction of cutting.

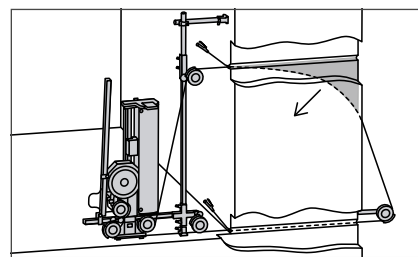

Vertical cutting with CS 10 and external pulleys.

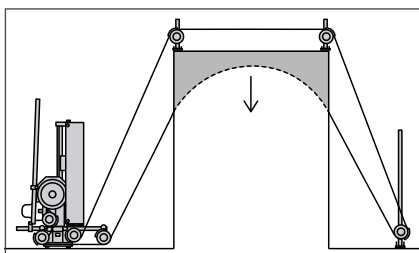

Push cutting with CS 10 and external pulleys.

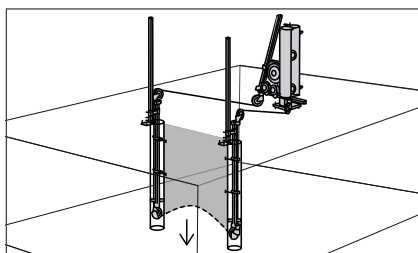

Push cutting with CS 10 and the push cutting kit.

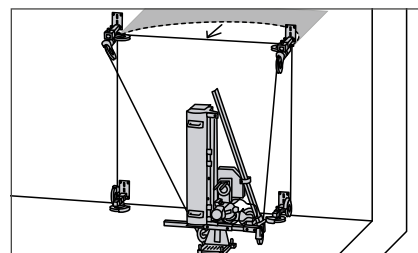

Horizontal cutting with CS 10 and external pulleys.

Husqvarna CS 2512 and CS 10.

ACCESSORIES		RRP	EXC VAT
1	Offset pulley double, slot	588 73 04-01	£ 1,802.58
2	Offset pulley double, slot/bearing	588 73 05-01	£ 1,330.02
3	Offset pulley single	587 44 30-01	£ 735.59
4	Offset pulley kit, round tube	588 53 99-01	£ 1,017.04
5	Push cutting kit	587 46 85-01	£ 3,518.49
6	Support kit	587 46 83-01	£ 429.38
7	Swivel pulley bearing for round tubes	531 11 44-67	£ 273.43
8	Swivel pulley sliding for round tubes	531 11 44-69	£ 219.49
9	Offset pulley, round tube	586 53 87-01	£ 421.62
10	Pivot wheel, bearing	586 53 58-01	£ 613.28
11	Pivot wheel, slot	586 53 84-01	£ 457.11
12	Pulley assy	581 31 59-01	£ 543.70
13	Offset pulley	586 53 67-01	£ 697.21
14	Foot	501 35 76-01	£ 137.48
15	Footplate	585 64 19-01	£ 138.19
16	Jointing sleeve, cross	585 64 05-01	£ 274.97
17	Jointing sleeve	585 64 30-01	£ 179.27
18	Baseplate bracket	586 53 72-01	£ 355.26
19	Baseplate assy	586 54 17-01	£ 317.44
20	Bracket parallel assy	586 53 92-01	£ 296.99
21	Angle bracket single pulley	586 54 21-01	£ 215.85
22	Angle bracket double pulley	587 44 33-01	£ 144.65
23	Round tubes, 3 m	531 11 95-80	£ 161.42
23	Round tubes, 2 m	531 12 06-42	£ 56.42
23	Round tubes, 1 m	531 12 06-41	£ 32.54
23	Round tubes, 0.25 m	531 11 44-72	£ 18.09
24	Column round tube	531 11 44-71	£ 64.38
25	Square tubes, 1.15 m	576 29 35-01	£ 28.00
25	Square tubes, 2 m	587 46 69-01	£ 143.68
26	Anchor plate	586 87 00-01	£ 248.66
27	Stabilisation bracket	584 25 38-01	£ 159.52
28	Stabilisation bracket (CS 10)	584 25 93-01	£ 205.14
29	Double clamp	531 11 44-60	£ 48.49
30	Coupling 90°	531 11 95-71	£ 8.28
31	Coupling, swiveling	522 80 99-01	£ 61.80
32	Support Ø 300 mm	586 54 08-01	£ 298.49
33	Support Ø 250 mm	586 54 05-01	£ 306.78
34	Holder assy	586 54 11-01	£ 251.27
35	Water lance	531 12 15-25	£ 62.93
36	Wrench 18 mm	531 11 90-65	£ 20.52
37	Wrench 22-24 mm	531 11 95-73	£ 6.84

SPARE PARTS		RRP	EXC VAT
38	Wheel cover	586 53 99-01	£ 360.55
39	Pressure control block (PP 455 E)	531 11 44-26	£ 310.01
40	Rubber ring, drive pulley	587 70 15-01	£ 90.62
41	Wear rubber drive wheel, Ø 400 mm (CS 10)	531 12 00-50	£ 27.95



1 Offset pulley double, slot



2 Offset pulley double, slot/bearing



3 Offset pulley single



4 Offset pulley kit, round tube

- 5 Push cutting kit:
- Baseplate assy
 - Bracket parallel assy
 - Pivot wheel, bearing
 - Pivot wheel, slot
 - Wheel cover
 - Support Ø 300 mm
 - Support Ø 250 mm
 - Holder assy



- 6 Support kit:
- Anchor plate
 - Stabilisation bracket
 - Stabilisation bracket for CS 10
 - Coupling, swiveling





7 Swivel pulley bearing for round tubes



8 Swivel pulley sliding for round tubes



9 Offset pulley for round tube



10 Pivot wheel, bearing



11 Pivot wheel, slot



12 Pulley assembly



13 Offset pulley



14 Foot



15 Footplate



16 Joining sleeve, cross



17 Joining sleeve



18 Baseplate bracket



19 Baseplate assembly



20 Bracket parallel assembly



21 Angle bracket single pulley



22 Angle bracket double pulley



23 Round tubes



24 Column round tube



25 Square tubes



26 Anchor plate



27 Stabilisation bracket for CS 2512



28 Stabilisation bracket for CS 10



29 Double clamp



30 Coupling 90°



31 Coupling, swiveling



32 Support Ø 300 mm



33 Support Ø 250 mm



34 Holder assembly



35 Water lance



36 Wrench 18 mm



37 Wrench 22-24 mm



38 Wheel cover



39 Pressure control block



40 Rubber ring, drive pulley



DIAMOND TOOLS FOR WIRE SAWING

Husqvarna offers a complete range of diamond wires, engineered for use with a variety of materials and numerous applications. Husqvarna diamond wires use injected synthetic rubber and springs for the assembly. A synthetic rubber wire is very flexible, making it easy to use, as well as minimising the risk of uneven wear to the wire beads. Husqvarna wires have at least 40 beads per metre. More beads per metre means increased contact between the cutting diamonds and the wire, resulting in higher speed and increased product life. Also, the distance between the beads is smaller, making for a more even cut. Available also in closed loop versions to eliminate the weakest link – the connection.

GOLD

See page 16 for more information.



VACUUM-BRAZED



SINTERED

MACHINE POWER	VACUUM-BRAZED				SINTERED		
	> 20 KW	15 KW		ALLROUND			
PRODUCT	C 1200	C 1000	C 950	C 900	C 777	C 770	C 740
MATERIAL							
Concrete	●	●●	●●●	●●●	●●●	●●●	●●
Reinforced concrete	●●	●●●	●●●	●●●	●●●	●●●	●●
Highly reinforced concrete	●●●	●●●	●●	●●	●	●	●
Metal	●●●	●●●	●●	●●	—	—	—
RECOMMENDED EQUIPMENT	CS 2512	CS 10, CS 2512		CS 10, CS 2512			

●●● = Optimal ●● = Good ● = Acceptable — = Not recommended

Husqvarna vacuum-brazed wires.

Highly efficient vacuum-brazed gold level wires for cutting steel, alloy and heavily reinforced concrete.

PRODUCT NUMBER	NUMBER OF BEADS /m	DIAMETER BEADS, MM	ASSEMBLY	CUTTING SYSTEM	RRP EXC VAT
C 1200					
543 07 77-08	53	10.3	Springs + rubber, vacuum-brazed beads	Dry/wet	£ POA
C 1000					
588 90 96-01	44	10.3	Springs + rubber, vacuum-brazed beads	Dry/wet	£ POA
C 950					
577 67 81-01	40	10.3	Springs + rubber, vacuum-brazed beads	Dry/wet	£ POA
C 900					
521 95 36-01	40	9.8	Springs + rubber, vacuum-brazed beads	Dry/wet	£ POA

Husqvarna closed loop wires.

Gold level wire without connection ideally suited for cutting in steel, sandwich and hollow structures.

PRODUCT NUMBER	NUMBER OF BEADS /m	DIAMETER BEADS, MM	ASSEMBLY	CUTTING SYSTEM	RRP EXC VAT
C 1200 SPL					
521 98 30-01	53	10.3	Springs + rubber, vacuum-brazed beads, closed loop	Dry/wet	£ POA
C 1000 SPL					
521 98 29-01	44	10.3	Springs + rubber, vacuum-brazed beads, closed loop	Dry/wet	£ POA
C 950 SPL					
577 67 82-01	40	10.3	Springs + rubber, vacuum-brazed beads, closed loop	Dry/wet	£ POA
C 900 SPL					
577 05 91-01	40	9.8	Springs + rubber, vacuum-brazed beads, closed loop	Dry/wet	£ POA

Husqvarna connector.

For vacuum-brazed wires.

PRODUCT NUMBER	OUTER DIAMETER, MM	INNER DIAMETER, MM	LENGTH, MM	CABLE DIAMETER, MM	TYPE	PRESS, TONNE	DIES PRESS	USE ON WIRE	RRP EXC VAT
577 32 55-01	8.4 (diamond bead 9.5)	5.1	24	5	SCR	4.5	PC(HT45)H5F-70	C 900	£ POA

Sintered wires.

High performance sintered wire for reinforced concrete.

PRODUCT NUMBER	NUMBER OF BEADS/M	DIAMETER BEADS, MM	ASSEMBLY	CUTTING SYSTEM	RRP EXC VAT
C 770					
543 06 44-04	40	11	Springs + rubber, sintered beads	Wet	£ POA
C 777					
586 60 69-01	40	11	Springs + rubber, sintered beads	Wet	£ POA
C 740					
591 39 63-01	40	11	Springs + rubber, sintered beads	Wet	£ POA

Accessories for diamond wires.

Husqvarna has a complete range of connectors designed for the wires. There are also appropriate hydraulic hand presses and corresponding dies for crimping the connectors.

PRODUCT NUMBER	OUTER DIAMETER, MM	INNER DIAMETER, MM	LENGTH, MM	CABLE DIAMETER, MM	TYPE	PRESS, TONNE	DIES PRESS	RRP EXC VAT
CONNECTOR, CYLINDER 16								
543 08 07-19	9	5.1	16	5	CYL9	4.5	PC(HT45)H5F-66*	£ 6.95
CONNECTOR, CYLINDER 20								
543 02 16-70	9	5.1	20	5	CYL9	4.5	PC(HT45)H5F-66*	£ 0.95
CONNECTOR, SCREWED								
543 02 15-15	9.5	5	24	5	SCR	4.5	PC(HT45)H5F-70*	£ 3.95
CONNECTOR, CARDAN								
543 02 15-84	9.5	5	27	5	CRD	4.5	PC(HT45)H5F-70*	£ 35.95

*Explanation of code: H5F-66/H5F-70 means that the die length is 5 mm and the distance between parallel sides of the hexagon is 6.6/7.0 mm.

Dies, press 66	543 00 28-89
Dies, press 70	543 00 28-78
Press, cembre 4.5 Tonne	543 00 06-70
Spare pin for cardan	543 02 15-90
Wire cooling dry steel cutting	576 37 83-01

WHERE INNOVATIVE ENGINEERING MEETS TOUGH PRODUCTIVITY DEMANDS

In walk-behind floor sawing, maximum productivity can only be achieved by a well thought out and balanced formula of power, ergonomics, torque, manoeuvrability and reliability. All factors must efficiently play together to get the most out of your working day. It's about the interplay between you, the machine and the diamond blade as a whole. This is what makes Husqvarna floor saws the ideal choice for maximum productivity.



LOW MAINTENANCE
Most Husqvarna floor saws feature the IntelliSeal blade shaft system that eliminates the need for daily greasing of the blade shaft bearings.



HIGH EFFICIENCY
The transmission system with right-angle gearbox enables power transfer to the blade shaft with optimum torque and minimal power loss.

Range overview.

The complete range of Husqvarna floor saws consists of 13 models with cutting depths from 122 mm to 625 mm, powered by engines from 4.2 kW petrol to 55.4 kW diesel, weighing from 54 kg to 1,038 kg. All our floor saws provide class-leading power and torque at the bladeshaft which means greater productivity when deep sawing. Here you can easily find the floor saw that provides you with the highest production rate.

Self-propelled floor saws

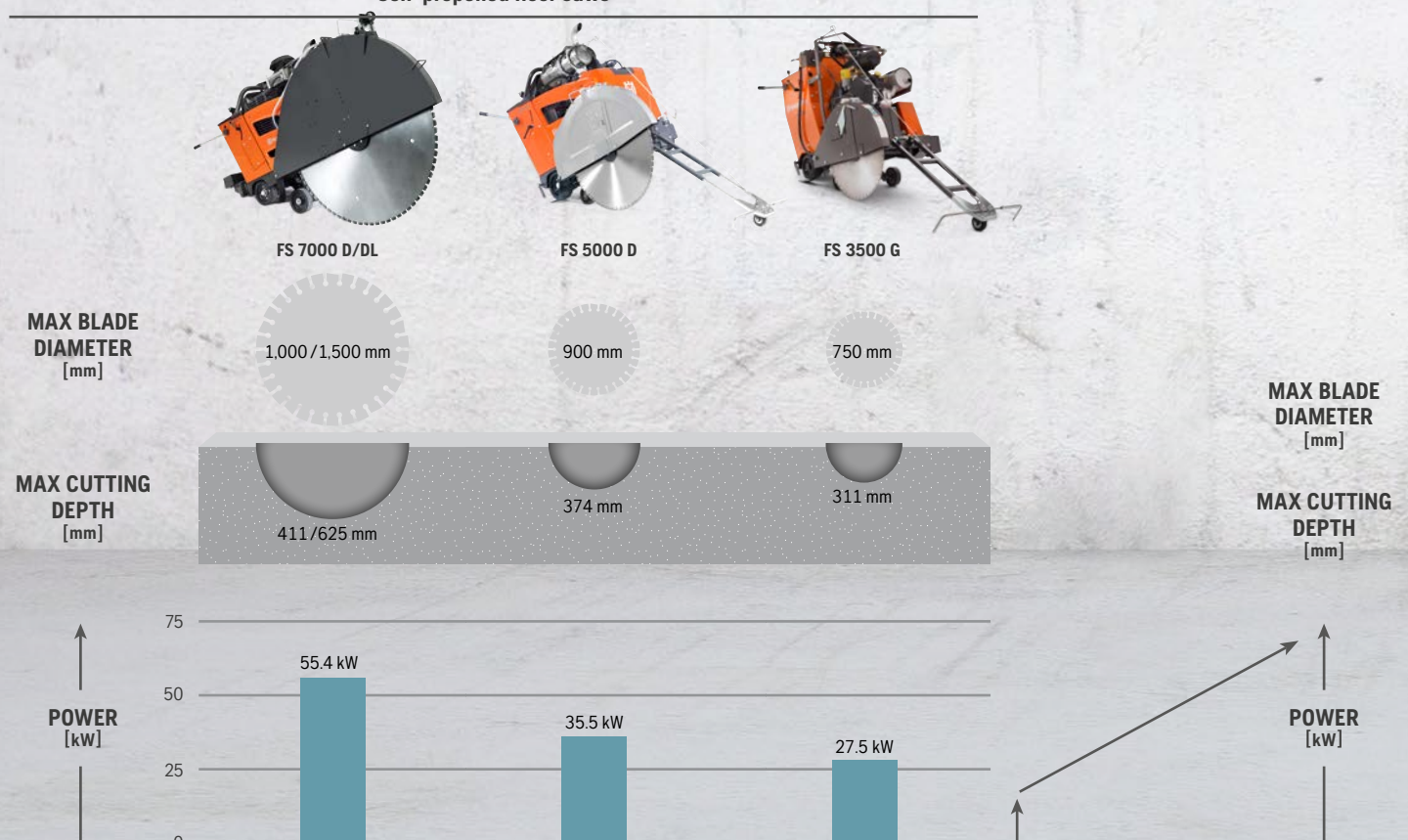

* Available in Australia, Latin America, Africa and parts of Asia.

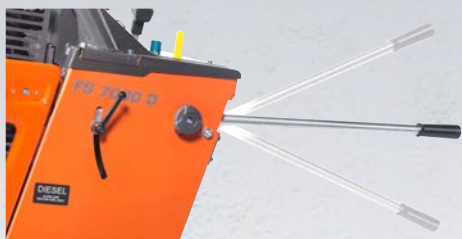

ERGONOMICAL The handlebars are adjustable to suit every operator's preference, while the layout of the controls allow for intuitive operation. All saws are developed to be highly maneuverable with low vibrations—ultimately reducing user fatigue.



STRAIGHT CUTS On FS 5000 D and FS 7000 D, the operator-friendly control panel includes a digital monitor. Pictured above is the Electronic Tracking Assistance mode. Straight cuts are easier to make, for higher productivity without extensive strain on the operator.



Count on productivity. Cut down on emissions.

Husqvarna FS 7000 D and FS 5000 D are faster and cleaner. The powerful modern diesel engines have low emissions compliant with Tier 4/Stage IIIB and provide fast, efficient sawing. The intuitive digital control panel and other convenient features help you work more efficiently.

Self-propelled floor saws

Push saws

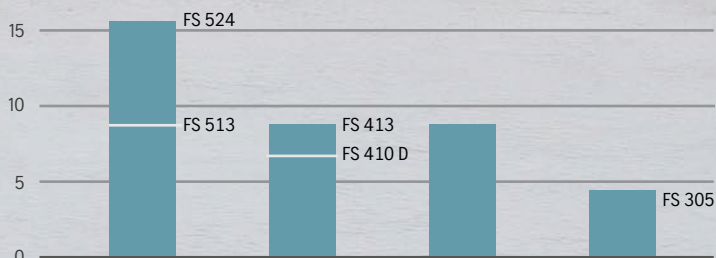
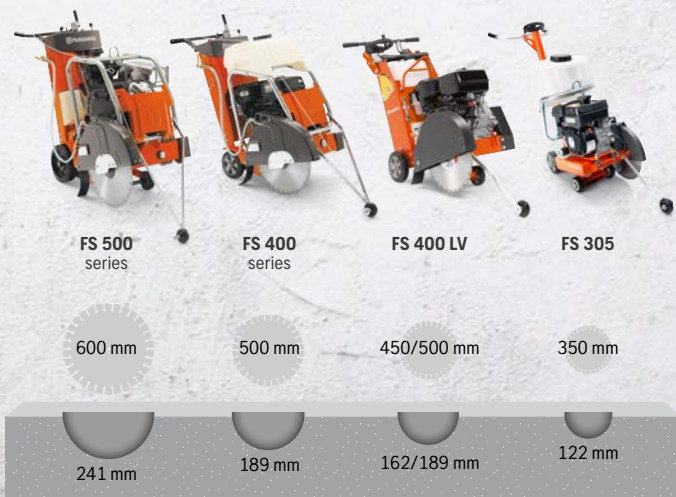

For more information, visit www.husqvarnacp.co.uk

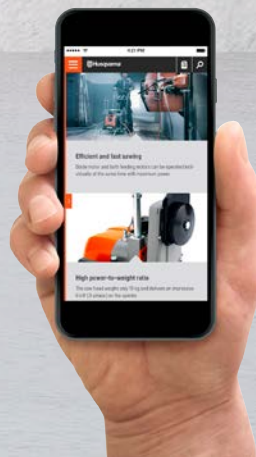



FLOOR SAWS	FS 7000 DL	FS 7000 D	FS 5000 D
TECHNICAL SPECIFICATIONS*			
Max depth of cut, mm	625 (500 without extension kit)	411	374
Blade depth control	Electrohydraulic	Electrohydraulic	Electrohydraulic
Max blade diameter, mm	1,500 (1,200 without extension kit)	1,000	900
Arbor size, mm	25.4	25.4	25.4
Transmission max speed, m/min	76	76	40
Engine manufacturer	Deutz	Deutz	Yanmar
Fuel	Diesel	Diesel	Diesel
Engine cooling	Liquid/Air	Liquid/Air	Liquid/Air
Max power, kW**	55.4	55.4	35.5
Power at blade shaft, kW	50.0	50.0	31.0
Number of ribs on belts	16	16	12
Dimensions, mm (L×W×H)	2,710×974×1,499 (2,370×974×1,499 without extension kit)	1,961×974×1,499	1,753×844×1,313
Weight, kg	1,338 (1,150 without extension kit)	1,032	771
RECOMMENDED EQUIPMENT			
	W 70 P	W 70 P	W 70 P
ARTICLE INFORMATION			
	967 05 60-08, 1,500 mm blade guard, front pivot with 3-speed gearbox, clutch, electrical tracking and fifth wheel	967 20 79-54, 1,000 mm blade guard, front pivot with 3-speed gearbox, clutch and electrical tracking	967 20 73-40, 900 mm blade guard, front pivot with 3-speed gearbox, clutch and electrical tracking
	967 05 60-09, 1,200 mm blade guard, front pivot with 3-speed gearbox, clutch and electrical tracking	967 20 79-45, 900 mm blade guard, front pivot with single speed gearbox, clutch and electrical tracking	967 20 73-38, 750 mm blade guard, front pivot with 3-speed gearbox, clutch and electrical tracking
			967 20 73-45, 900 mm blade guard, front pivot with single speed gearbox, clutch and electrical tracking
			967 20 73-39, 500 mm blade guard, front pivot with single speed gearbox, clutch and electrical tracking
RRP EXC VAT			
	£ POA	£ POA	£ POA

Selection of variants shown in table. Contact salesman for all variants available. *Full technical specifications are available on our web site. **As rated by the engine manufacturer.

Husqvarna FS 7000 DL and FS 7000 D.

ACCESSORIES AND SPARE PARTS	RRP EXC VAT
2 Blade guard slip-on, 500 mm	586 34 32-01 £ 489.23
2 Blade guard slip-on, 600 mm	586 34 33-01 £ 1,331.00
2 Blade guard slip-on, 750 mm	586 34 34-01 £ 1,220.53
2 Blade guard slip-on, 900 mm	586 34 35-01 £ 1,081.73
2 Blade guard slip-on, 1,000 mm	586 34 36-01 £ 1,724.50
3 Dual light kit	585 92 46-01 £ 516.77
4 Water pump kit	586 01 23-01 £ 817.84
5 Weight kit, 30 kg	581 67 89-02 £ 277.42
5 Weight kit, 15 kg	581 67 89-01 £ 155.09
6 Factory installed fifth wheel kit without weight bracket kit (FS 7000 D)	582 55 72-01 £ POA
6 Factory installed fifth wheel kit with weight bracket kit (FS 7000 D)	501 74 47-01 £ POA
6 Field installed fifth wheel kit (FS 7000 D)	582 30 79-01 £ 2,174.59
Unit conversion kit 900-1,000 mm for 3-speed gear box	589 55 36-01 £ POA
Unit conversion kit 1,500 mm for 3-speed gear box	589 55 38-01 £ POA

ACCESSORIES AND SPARE PARTS	RRP EXC VAT
1-speed blade shaft belt, 900 mm	524 19 97-64 £ 46.98
3-speed blade shaft belt, 900 mm	541 20 08-47 £ 63.25
Blade guard bolt-on system 1,200 mm for 3-speed gear box	582 55 35-01 £ 3,774.83
Blade guard bolt-on system 1,500 mm for 3-speed gear box	582 55 36-01 £ 4,718.54
Blade collar (outer flange with drive pin), 114 mm	586 00 92-01 £ 76.22
Blade collar (outer flange with drive pin), 127 mm	586 00 93-01 £ 162.95
Blade collar (outer flange with drive pin), 152 mm	586 00 94-01 £ 109.11
Blade collar (outer flange with drive pin), 178 mm	586 00 95-01 £ 140.54
Blade shaft wrench	504 62 64-03 £ 76.60
Drive pin, 350-750 mm	505 53 19-01 £ 2.32
Drive pin, 900-1,000 mm	539 30 00-10 £ 1.66

900 & 1000 mm slip on blade guards require a fitting kit to be able to fit them to a FS 7000 DL



FS 3500 G

311
Electrohydraulic
750
25.4
45
Kohler
Petrol
Air
27.5
21.5
25
1,410×800×1,135
419

W 70 P

967 67 37-07, 750 mm blade guard

967 67 37-06, 650 mm blade guard

£ POA

Husqvarna FS 5000 D.

ACCESSORIES AND SPARE PARTS	RRP	EXC	VAT
2 Blade guard slip-on, 350 mm	586 34 31-01	£ 1,422.81	
2 Blade guard slip-on, 500 mm	586 34 32-01	£ 489.23	
2 Blade guard slip-on, 600 mm	586 34 33-01	£ 1,331.00	
2 Blade guard slip-on, 750 mm	586 34 34-01	£ 1,220.53	
2 Blade guard slip-on, 900 mm	586 34 35-01	£ 1,081.73	
3 Dual light kit	585 92 46-01	£ 516.77	
4 Water pump kit	586 01 23-01	£ 817.84	
6 Factory installed fifth wheel kit (FS 5000 D)	501 74 46-01	£ 1,876.00	
6 Field installed fifth wheel kit (FS 5000 D)	582 30 78-01	£ 1,876.00	
3-speed blade shaft belt 750 mm	585 51 50-01	£ 45.37	
Blade collar (outer flange with drive pin), 114 mm	586 00 92-01	£ 76.22	
Blade collar (outer flange with drive pin), 127 mm	586 00 93-01	£ 162.95	
Blade collar (outer flange with drive pin), 152 mm	586 00 94-01	£ 109.11	
Blade shaft wrench	504 62 64-03	£ 76.60	
Drive pin, 350-750 mm	505 53 19-01	£ 2.32	
Drive pin, 900-1,000 mm	539 30 00-10	£ 1.66	

1 Blade guard slip-on for FS 4800 D and FS 6800 D



2 Blade guard slip-on for FS 7000 DL / D and FS 5000 D



4 Water pump kit



3 Dual light kit



5 Weight kit for FS 7000 DL / FS 7000 D



6 fifth wheel kit for FS 7000 DL / FS 7000 D and FS 5000 D



Husqvarna FS 3500 G.

ACCESSORIES AND SPARE PARTS	RRP	EXC	VAT
4 Water pump kit (factory installed)	590 86 96-01	£ POA	
4 Water pump kit (field installed)	592 91 67-01	£ POA	
12 V outlet (factory installed)	591 11 75-01	£ POA	
12 V outlet (field installed)	592 91 73-01	£ POA	
Transportation wheel (factory installed)	590 87 98-01	£ POA	
Transportation wheel (field installed)	592 91 69-01	£ POA	
Water safety switch (factory installed)	590 87 13-01	£ POA	
Water safety switch (field installed)	592 91 68-01	£ POA	
Light kit (factory installed)	591 13 96-01	£ POA	
Light kit (field installed)	592 91 75-01	£ POA	
Parking brake (factory installed)	590 89 45-01	£ POA	
Parking brake (field installed)	592 91 72-01	£ POA	
Easy lubrication (factory installed)	590 88 80-01	£ POA	
Easy lubrication (field installed)	592 91 71-01	£ POA	
Weight, 1 piece, max 2	501 74 66-01	£ POA	

For complete list of spare parts see Illustrated Part List (IPL) on our web site.

**TAKE CARE OF CONCRETE
DUST AND SLURRY IN A SMART
EASY AND EFFICIENT WAY!**

SEE THE SYSTEMS GUIDE ON PAGE 68



FLOOR SAWS	FS 524	FS 413
TECHNICAL SPECIFICATIONS*		
Max depth of cut, mm	241	189
Blade depth control	Handwheel	Handwheel
Max blade diameter, mm	600	500
Arbor size, mm	25.4	25.4
Engine manufacturer	Honda	Honda
Engine cooling	Air	Air
Max power, kW**	15.5	8.7
Fuel	Petrol	Petrol
Dimensions, mm (L×W×H)	1,750×660×1,200	1,550×655×1,200
Weight, kg	231	163
RECOMMENDED EQUIPMENT		
	W 70 P	W 70 P
ARTICLE INFORMATION		
	967 04 61-02, incl. water tank	965 15 01-02, incl. water tank
RRP EXC VAT	£ 7,780.56	£ 3,149.76

*Full technical specifications are available on our web site. **As rated by the engine manufacturer.

Husqvarna FS 500 Series.

ACCESSORIES AND SPARE PARTS		RRP	EXC VAT
1	Water tank kit	541 20 82-86	£ 80.59
2	Lifting bail	522 47 87-02	£ 141.62
	Blade flange outer with pin	542 16 79-62	£ 53.95
	Blade nut	542 16 78-46	£ 4.77
	Blade shaft belt (FS 513)	542 20 21-50	£ 30.65
	Blade shaft belt (FS 524)	504 06 83-01	£ 35.03
	Lower transmission belt	505 24 62-01	£ 18.95
	Upper transmission belt	510 23 72-01	£ 23.77
	Wrench 27 mm	542 20 22-92	£ 2.79

Husqvarna FS 400 Series.

ACCESSORIES AND SPARE PARTS		RRP	EXC VAT
2	Lifting bail (FS 410 D, FS 413)	522 47 87-02	£ 141.62
	Blade flange outer with pin	542 16 79-62	£ 53.95
	Blade shaft belt (FS 410 D)	543 04 49-63	£ 31.11
	Blade shaft belt (FS 413)	542 20 21-50	£ 30.65
	Water tank kit	541 20 82-86	£ 80.59
	Wrench 27 mm	542 20 22-92	£ 2.79

Husqvarna FS 400 LV.

ACCESSORIES AND SPARE PARTS		RRP	EXC VAT
	Blade flange kit (inner and outer flange)	595 28 08-01	£ 93.95
	Blade shaft belt	543 04 49-64	£ 29.74
	Wrench 16/18 mm	543 04 59-04	£ 18.63

Husqvarna FS 300 Series.

ACCESSORIES AND SPARE PARTS		RRP	EXC VAT
	Blade flange outer	504 06 40-01	£ 30.35
	Blade screw	725 25 34-71	£ 3.49
	Blade shaft belt (FS 305)	543 85 03-68	£ 18.81
	Blade shaft belt (FS 309)	502 08 31-01	£ 20.24
	Wrench 16/18 mm	543 04 59-04	£ 18.63
	Wrench 13 mm	543 04 58-91	£ 3.37

For complete list of spare parts see Illustrated Part List (IPL) on our web site.



1 Water tank kit for FS 400 series



2 Lifting bail for FS 400 series



FS 410 D



FS 400 LV



FS 305

189
Handwheel
500
25.4
Yanmar
Air
6.6
Diesel
1,550×655×1,200
163

162
Handwheel
450/500
25.4
Honda
Air
8.7
Petrol
1,150×590×940
99/120

125
Handwheel
350
25.4
Honda
Air
3.6
Petrol
915×381×990
54

W 70 P

W 70 P

W 70 P

965 15 01-01, incl. water tank

965 14 82-01, 450 mm
967 79 65-01, 500 mm

965 15 00-26, incl. water tank

£ 3,994.32

450 mm - £ 2,266.00
500 mm - £ 2,544.90

£ 1,787.04

**TAKE CARE OF CONCRETE
DUST AND SLURRY IN A SMART
EASY AND EFFICIENT WAY!**

SEE THE SYSTEMS GUIDE ON PAGE 68



Blades for high- and mid-powered floor saws.

MACHINE POWER

PRODUCT

SEGMENT SHAPE

MATERIAL

Cured concrete, hard
 Cured concrete, medium
 Cured concrete, soft
 Green concrete, hard
 Green concrete, soft
 Asphalt, hard
 Asphalt, soft

RECOMMENDED EQUIPMENT

Blades for low-powered floor saws.

DIAMOND BLADES FOR FLOOR SAWING

Husqvarna floor sawing diamond blades cover most applications, ranging from sawing asphalt to sawing in heavily reinforced concrete, with equipment ranging from small electric units to large diesel-powered machines. Husqvarna also offers blades developed for slot cutting for electric and electronic cables as installation of traffic loops. The slot cutting blades can also be used in other joint widening applications.

MACHINE POWER

PRODUCT

SEGMENT SHAPE

MATERIAL

Natural stone
 Reinforced concrete
 Abrasive material
 Green concrete
 Asphalt

RECOMMENDED EQUIPMENT

Revolutionary diamond tool technology for great cutting capacity and durability.

One of the greatest benefits with the Diagrip™ technology is how fast and smooth the diamond tools go through all types of construction materials. Diagrip™ tools mean trouble-free sawing, especially in heavily reinforced concrete.

The diamonds are specially treated to remain in place in the segments longer, and are distributed optimally, delivering maximum efficiency to every diamond. With Diagrip™ the diamonds are exposed and expended at an even rate, which makes the edge very even and powerful, even when cutting hard materials like reinforced concrete.

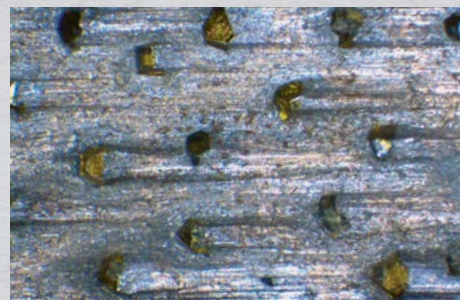



F1500 DIAGRIP™



F1570

F1100



L600



F500 DIAGRIP™

35 KW		→ 35 KW			→ 35 KW	35 → KW		25 - 35 KW	
F1510	F1520	F1530	F1540	F1570	F1170	L630	L680	F525	
●●●	●●	●●	—	—	—	●●	—	●●●	
●●	●●●	●●●	●●	—	—	●●●	—	●●	
—	—	—	●●●	—	—	—	—	—	
—	—	—	—	—	—	—	—	—	
—	—	—	—	●●●	●●●	—	●●●	—	
—	—	—	—	●●●	●●	—	●●●	—	
FS 4800, FS 5000 D		FS 7000 D, FS 8400 D			FS 7000 D	FS 5000 D	FS 5000 D, FS 4800 D		Electric and FS 3500 G

●●● = Optimal ●● = Good ● = Acceptable — = Not recommended



ELITE-CUT

VARI-CUT

TACTI-CUT

3.5-25 KW				3.5-25 KW			3.5-25 KW		
S35	S45	S65	S85	S45	S65 PLUS	S85	S50 PLUS	S65	S85
●●●	—	—	—	—	—	—	—	—	—
●●●	●●●	●●●	—	●●●	●●	—	●●	●●●	—
●	●●	●●●	●	●●	●●●	●	●●	●●●	●
—	●	●●	●●	—	●●	●●	—	●●	●●
—	—	●	●●●	—	●	●●●	—	●	●●●
FS 524/513, FS 413/410 D, FS 400 LV, FS 309/305									

●●● = Optimal ●● = Good ● = Acceptable — = Not recommended



- GOLD
- SILVER
- BRONZE

See page 16 for more information.

SPEED BRIDGE The Elite-Cut S 35 blade feature a specially designed Speed Bridge between the segments. This design improves the cutting speed and smoothness even further through reduced lateral friction, better cooling and improved dust evacuation.

Husqvarna F 1510/ F 1520/ F 1530/ F 1540 Diagrip™.

Gold level blades for high-powered floor saws. Wide range of blades to deliver optimal performance in every application.

PRODUCT NUMBER	DIAMETER, MM	WATER SLOTS	SEGMENT LENGTH, MM	SEGMENT WIDTH, MM	BORE, MM	BOLT PATTERN	RRP, EXC. VAT
HUSQVARNA F 1510							
597 15 43-01	600	Narrow	40	4.2	25.4	PL70132	£ 594.18
597 15 43-03	600	Narrow	40	5.0	25.4	PL70132	£ 594.18
597 15 45-01	750	Narrow	40	4.7	25.4	PL70132	£ 987.69
597 15 45-02	750	Narrow	40	4.7	25.4	PL70132	£ 987.69
597 15 46-02	900	Narrow	40	4.7	25.4	PL70135	£ 1,180.14
597 15 47-01	1,000	Narrow	40	4.5	25.4	PL70135	£ 1,312.43
592 75 23-14	1,200	Narrow	40	4.5	25.4	PL70135	£ 1,926.29
592 75 23-15	1,500	Narrow	40	4.5	25.4	PL70135	£ 3,024.95
HUSQVARNA F 1520							
597 15 48-01	600	Narrow	40	4.2	25.4	PL70132	£ 594.18
597 15 48-03	600	Narrow	40	5.0	25.4	PL70132	£ 594.18
597 15 50-01	750	Narrow	40	4.2	25.4	PL70132	£ 987.69
597 15 50-03	750	Narrow	40	4.7	25.4	PL70132	£ 987.69
591 09 86-21	900	Narrow	40	4.2	25.4	PL70135	£ 1,180.14
597 15 51-02	900	Narrow	40	4.7	25.4	PL70135	£ 1,180.14
597 15 52-01	1,000	Wide	40	4.5	25.4	PL70135	£ 1,312.43
591 09 86-19	1,200	Wide	40	4.5	25.4	PL70135	£ 1,926.29
591 09 86-20	1,000	Wide	40	4.5	25.4	PL70135	£ 3,024.95
HUSQVARNA F 1530							
597 15 56-01	600	Narrow	40	4.2	25.4	PL70132	£ 594.18
597 15 56-04	600	Narrow	40	5.0	25.4	PL70132	£ 594.18
597 15 59-01	750	Narrow	40	4.2	25.4	PL70132	£ 987.69
597 15 59-03	750	Narrow	40	4.7	25.4	PL70132	£ 987.69
591 09 87-26	900	Narrow	40	4.2	25.4	PL70135	£ 1,180.14
597 15 60-02	900	Narrow	40	4.7	25.4	PL70135	£ 1,180.14
597 15 61-01	1,000	Wide	40	4.5	25.4	PL70135	£ 1,312.43
591 09 87-16	1,200	Wide	40	4.5	25.4	PL70135	£ 1,577.76
591 09 87-17	1,500	Wide	40	4.5	25.4	PL70135	£ 3,024.95
HUSQVARNA F 1540							
597 15 62-01	600	Narrow	40	4.2	25.4	PL70132	£ 594.18
597 15 62-02	600	Narrow	40	4.7	25.4	PL70132	£ 594.18
597 15 62-04	600	Narrow	40	5.0	25.4	PL70132	£ 594.18
597 15 64-01	750	Narrow	40	4.2	25.4	PL70132	£ 987.69
597 15 64-03	750	Narrow	40	4.7	25.4	PL70132	£ 987.69
597 15 65-01	900	Narrow	40	4.2	25.4	PL70135	£ 1,180.14
597 15 65-03	900	Narrow	40	4.7	25.4	PL70135	£ 1,180.14
597 15 66-01	1,000	Wide	40	4.5	25.4	PL70135	£ 1,312.43
591 12 40-14	1,200	Wide	40	4.5	25.4	PL70135	£ 1,577.76

1,200 and 1,500 mm F 1500 series concrete blades are delivered with PL70135 hole pattern as standard.

Husqvarna F 1570 Diagrip™.

Gold level asphalt blades with recessed or lowered segments as undercut protection.

PRODUCT NUMBER	UNDERCUT PROTECTION	DIAMETER, MM	WATER SLOTS	SEGMENT LENGTH, MM	SEGMENT WIDTH, MM	BORE, MM	RRP EXC VAT
592 74 62-01	Recessed	500	Narrow	40	4.5	25.4	£ 837.09
592 74 62-02	Recessed	600	Narrow	40	4.5	25.4	£ 1,020.20
592 74 62-05	Recessed	750	Narrow	40	4.5	25.4	£ 1,344.95

Husqvarna F 1170.

Silver level asphalt blades with recessed or lowered segments as undercut protection.

PRODUCT NUMBER	UNDERCUT PROTECTION	DIAMETER, MM	WATER SLOTS	SEGMENT LENGTH, MM	SEGMENT WIDTH, MM	BORE, MM	RRP EXC VAT
589 55 42-01	Recessed	500	Wide	40	4.5	25.4	£ 726.85
583 81 17-02	Recessed	600	Wide	40	4.5	25.4	£ 820.65
589 55 44-01	Recessed	750	Wide	40	4.5	25.4	£ 1,018.33
589 35 44-02	Recessed	900	Wide	40	4.5	25.4	£ 1,334.86
589 55 45-01	Recessed	1,000	Wide	40	4.5	25.4	£ 1,756.39
589 35 66-02	Recessed	1,200	Wide	40	4.5	25.4	£ 1,824.03

Other dimensions available on request.



SR 31

Husqvarna L 630 / L 680.

Gold level blades for slot cutting and traffic loops with sandwich design that helps them retain their shape.

PRODUCT NUMBER	DIAMETER, MM	WATER SLOTS	SEGMENT LENGTH, MM	SEGMENT WIDTH, MM	BORE, MM	SEGMENT HEIGHT, MM	RRP EXC VAT
HUSQVARNA L 630							
531 16 15-65	350	Wide	40	6	25.4	11.0	£ 498.54
531 16 15-66	350	Wide	40	8	25.4	11.0	£ 604.28
531 16 15-59	350	Wide	40	10	25.4	11.0	£ 672.66
531 15 92-13	450	Wide	40	6	25.4	11.0	£ 627.82
531 16 15-25	450	Wide	40	8	25.4	11.0	£ 616.61
531 16 15-24	450	Wide	40	10	25.4	11.0	£ 829.61
531 16 16-59	450	Wide	40	12	25.5	11.0	£ 997.78
531 16 16-34	450	Wide	40	15	25.6	11.0	£ 1,233.21
522 75 79-01	450	Wide	40	20	25.7	11.0	£ 1,648.02
HUSQVARNA L 680							
531 16 15-03	350	Wide	40	6	25.4	11.0	£ 498.54
531 10 18-79	350	Wide	40	8	25.4	11.0	£ 604.28
531 16 15-02	350	Wide	40	10	25.4	11.0	£ 672.66
579 24 10-01	350	Wide	40	15	25.4	11.0	£ 1,113.63
575 85 48-05	400	Wide	40	15	25.4	11.0	£ 1,233.21
531 16 05-02	450	Wide	40	6	25.4	11.0	£ 627.82
531 16 05-03	450	Wide	40	8	25.4	11.0	£ 616.61
531 16 05-06	450	Narrow	40	8	25.4	11.0	£ 691.35
531 16 05-04	450	Wide	40	10	25.4	11.0	£ 829.61
531 16 05-07	450	Narrow	40	10	25.4	11.0	£ 829.61
522 75 80-04	450	Wide	40	15	25.4	11.0	£ 1,289.27
522 75 80-01	450	Wide	40	20	25.4	11.0	£ 1,648.02

Other dimensions available on request.

Husqvarna Elite-Cut floor saw blades.

Gold level blades for easy operation even in heavily reinforced concrete. Innovative segment design for efficient cutting, cooling and slurry evacuation, which increases both cutting speed and service life. Diagrip™ technology featured in S 35, S 45, S 65 and S 85.

PRODUCT NUMBER	DIAMETER, MM	BLADE GEOMETRY	SEGMENT SHAPE	SEGMENT HEIGHT, MM	BORE, MM	RRP EXC VAT
S 35						
579 81 15-10	300	Segmented	Bridge	15	25.4 / 20	£ 166.60
579 81 15-20	350	Segmented	Bridge	15	25.4 / 20	£ 208.25
579 81 15-30	400	Segmented	Bridge	15	25.4 / 20	£ 255.11
579 82 06-50	450	Segmented	Bridge	15	25.4	£ 312.37
S 45						
579 81 16-20	350	Segmented	Double notch	12	25.4 / 20	£ 208.25
579 81 16-30	400	Segmented	Double notch	12	25.4 / 20	£ 255.11
579 82 07-50	450	Segmented	Double notch	12	25.4	£ 312.37
579 82 07-60	500	Segmented	Double notch	12	25.4	£ 385.25
579 82 07-70	600	Segmented	Double notch	12	25.4	£ 426.91
S 65						
579 81 19-20	350	Segmented	Double notch	12	25.4 / 20	£ 208.25
579 81 19-30	400	Segmented	Double notch	12	25.4 / 20	£ 255.11
579 82 08-50	450	Segmented	Double notch	12	25.4	£ 312.37
579 82 08-60	500	Segmented	Double notch	12	25.4	£ 385.25
579 82 08-70	600	Segmented	Double notch	12	25.4	£ 426.91
S 85						
579 81 20-20	350	Segmented	Flat / Flat +	12	25.4 / 20	£ 208.25
579 81 20-30	400	Segmented	Flat / Flat +	12	25.4 / 20	£ 255.11
579 80 95-50	450	Segmented	Flat / Flat +	12	25.4	£ 312.37
579 80 95-60	500	Segmented	Flat / Flat +	12	25.4	£ 385.25
579 80 95-70	600	Segmented	Flat / Flat +	12	25.4	£ 426.91

Husqvarna Vari-Cut floor saw blades.

Silver level blades with high cutting speed and wear resistance, providing excellent performance and low tool cost per cut square metre.

PRODUCT NUMBER	DIAMETER, MM	BLADE GEOMETRY	SEGMENT SHAPE	SEGMENT HEIGHT, MM	BORE, MM	RRP EXC VAT
S 45						
579 81 74-20	350	Segmented	Turbo/Flat	10	25.4 /20	£ 153.52
579 81 74-30	400	Segmented	Turbo/Flat	10	25.4 /20	£ 181.80
579 82 09-50	450	Segmented	Turbo/Flat	10	25.4	£ 235.33
579 82 09-60	500	Segmented	Turbo/Flat	10	25.4	£ 287.85
S 65 PLUS						
587 90 45-01	350	Segmented	Turbo/Flat /Flat +	10	25.4 /20	£ 153.52
587 90 53-01	400	Segmented	Turbo/Flat /Flat +	10	25.4 /20	£ 181.80
587 90 54-01	450	Segmented	Turbo/Flat /Flat +	10	25.4	£ 235.33
579 82 10-60	500	Segmented	Turbo/Flat /Flat +	10	25.4	£ 287.85
S 85						
579 81 77-20	350	Segmented	Flat +	10	25.4 /20	£ 153.52
579 81 77-30	400	Segmented	Flat +	10	25.4 /20	£ 181.80
579 80 96-50	450	Segmented	Flat +	10	25.4	£ 235.33
579 80 96-60	500	Segmented	Flat +	10	25.4	£ 287.85

Husqvarna Tacti-Cut floor saw blades.

Bronze level blades optimised for less intensive professional cutting in most materials, providing a good balance between performance and price.

PRODUCT NUMBER	DIAMETER, MM	BLADE GEOMETRY	SEGMENT SHAPE	SEGMENT HEIGHT, MM	BORE, MM	RRP EXC VAT
S 50 PLUS						
579 81 56-20	350	Segmented	Flat	13	25.4 /20	£ 80.79
579 81 56-30	400	Segmented	Flat	13	25.4 /20	£ 150.49
S 65						
579 81 65-10	300	Jointed segments	Turbo/Flat +	10	25.4 /20	£ 97.30
579 81 65-20	350	Jointed segments	Turbo/Flat +	10	25.4 /20	£ 126.83
579 81 65-30	400	Jointed segments	Turbo/Flat +	10	25.4 /20	£ 150.49
S 85						
579 81 66-10	300	Segmented	Flat +	10	25.4 /20	£ 97.30
579 81 66-20	350	Segmented	Flat +	10	25.4 /20	£ 126.83
579 81 66-30	400	Segmented	Flat +	10	25.4 /20	£ 150.49

HERE'S WHAT MAKES DRILLING SPECIALISTS MORE EFFICIENT

When developing and improving our drill motors, drill stands and diamond bits we look at the whole system, turning every bit and piece to find out how we can make skilled drilling operators work even more efficiently and effortlessly. More holes drilled per working hour. More turnover per operator. That's what a Husqvarna core drilling system is designed for.

Range overview.

Husqvarna drill systems consist of powerful drill motors and sturdy stands. Power options available from the electric handheld 1.9 kW DM 220 to the hydraulic 9.3 kW DM 406 H. Recommended maximum drilling diameters range from 150 mm to 650 mm. For highest production rate, choose the system/systems optimal for your kind of operation.



REC. MAX DRILLING DIAMETER [mm]

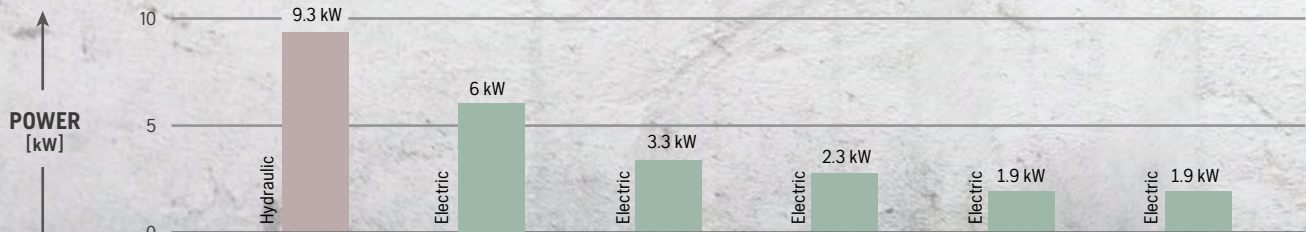



**HUSQVARNA PRIME™ PRODUCT RANGE
- LIGHT EQUIPMENT FOR HEAVY JOBS**

Our range of high frequency PRIME™ equipment offers outstanding power-to-weight ratio and exceptional usability. You can do wall sawing, drilling and handheld cutting using the same power source. In short, more jobs done with smaller and lighter equipment



FLEXIBLE POWER You can use Husqvarna DM 650/PP 65 with both 3-phase and 1-phase power. With 1-phase power the system delivers 3 kW on the spindle, making DM 650 one of the most powerful 1-phase drill motors on the market.

HUSQVARNA DM 650 is a very powerful and versatile electric drill motor equipped with high frequency PRIME™ technology. The high power output, low weight, user-friendly setup and intelligent design makes Husqvarna DM 650 suitable for most drilling applications. The drill speed can be optimised in 9 steps while running.

DS 50 GYRO STAND makes it possible to drill many holes from one position, in various directions and angles. Ideal for efficient stitch drilling! Installs very quickly without need for anchoring bolts.



HUSQVARNA AD 10, our automatic drill system, communicates with the drill motor to optimise the feed rate. This results in faster drilling and less wear on the diamond tool. Best of all, you can work more efficiently when you do not have to crank the feed by hand.

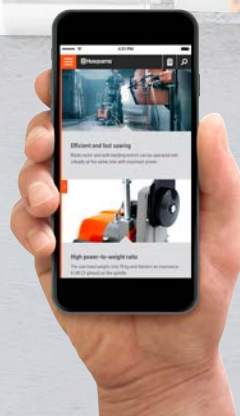

For more information, visit www.husqvarnacp.co.uk



DRILL MOTORS	DM 650	DM 340	DM 280
TECHNICAL SPECIFICATIONS			
Power, W	6,000/3,000	3,300	2,700
Motor	3-phase/1-phase, electric	1-phase, electric	1-phase, electric
Voltage, V	400/230, connected to PP 65, PP 220	230	230/110
Motor, Amps	16	30	24
Plug size, Amps	16	32	32
Speeds	18 (2 mechanical, 9 electrical)	3	3
Spindle speed unloaded, rpm	126-242* (1 speed)/ 273-502* (2 speed)	310/690/1,190	450/1,000/1,730** 310/690/1,190***
Spindle speed loaded, rpm	113-218* (1 speed)/ 246-452* (2 speed)	240/530/915	360/800/1,380** 250/550/950***
Rec drill diameter, mm	112-600	50-400	High speed 25-250 Low speed 50-350
Rec drill diameter handheld, mm	—	—	—
Mounting collar, mm	—	—	—
Spindle thread, outer	1 1/4" 7 UNC	1 1/4" 7 UNC	1 1/4" 7 UNC
Spindle thread, inner	—	—	—
UNC water coupling	G 1/4"	G 1/4"	G 1/4"
Sound pressure level, dB (A)	98	88	88
Sound power level, dB (A)	113	97	97
Weight, kg	14.0	14.0	13.0
Flow, max l/min	—	—	—
Pressure, max bar	—	—	—
RECOMMENDED EQUIPMENT			
Power pack	PP 490, PP 65, PP 220		
Drill stand	DS 900	DS 450, DS 50 Gyro	DS 450, DS 50 Gyro
Dust extractors	W70 P	W70 P, S36	W70 P
GENERATOR AND TRANSFORMER INFORMATION			
Minimum transformer size, VA	—	4,125 (4,225 with AD 10)	3,000
Transformer Continuous or Intermittent	—	Continuous	Continuous
Minimum generator requirement, k VA	10	10	6.6
ARTICLE INFORMATION			
	966 56 36-01, DM 650	965 98 72-07, 230 V 965 98 72-05, 110 V	966 55 41-06, 230 V, high speed 966 55 41-01, 230 V, low speed 966 55 41-10, 110 V high speed 966 55 41-05, 110 V low speed
RRP EXC VAT	£ 3,992.28	110 V - £ 1,860.18 230 V - £ 2,172.27	110 V - £ 1,695.38 230 V - £ 1,749.97

*9 electronic gears **High speed version. ***Low speed version.

APPLICATION OVERVIEW

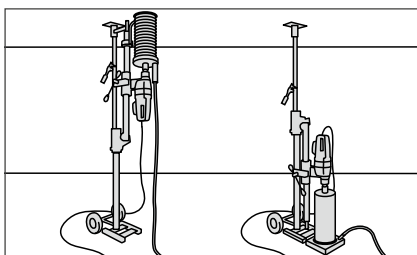

Vertical drilling, upwards and downwards.

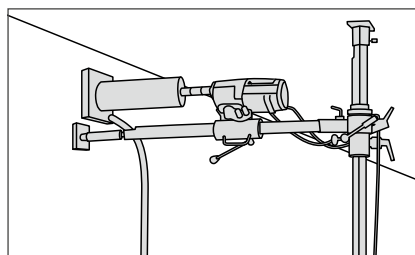

Horizontal drilling.

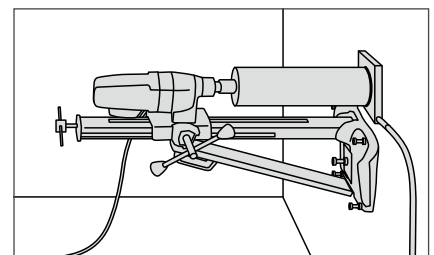

Drilling for channels, pipes and cables.

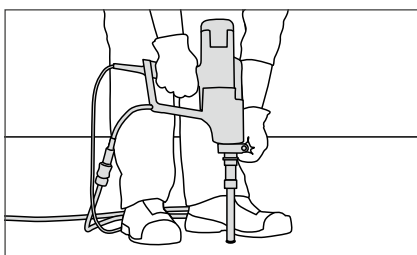

Drilling for barriers.

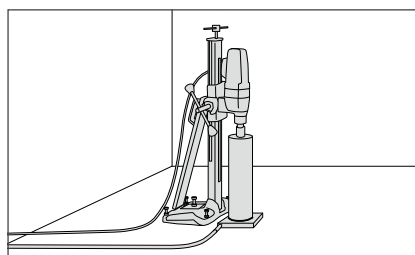

Vertical drilling.

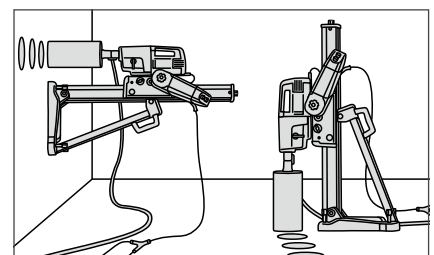

Automatic drilling in all applications.



DM 230



DM 220



DM 406 H

1,850

1-phase, electric

230/110

16

16

3

730/1,700/3,600

580/1,400/2,900

150

80

60

1 1/4" 7 UNC

G 1/2" or 5/8" 11 UNC

G 1/4"

90

94

7.0

—

—

DS 150, DS 250

W 70 P, S 26, S 13 Dry

2,500

Continuous

5.7

968 41 10-01, 1/2" inner thread, 230 V

968 41 11-01, 1/2" inner thread, 110 V

110 V – £ 1,215.40

230 V – £ 1,266.90

1,850

1-phase electric

230/110

16

16

3

730/1,700/3,600

580/1,400/2,900

150

80

—

1 1/4" 7 UNC

G 1/2" or 5/8" 11 UNC

G 1/4"

90

94

7.5

—

—

DS 250

W 70 P, S 13 Dry

2,500

Continuous

5.7

966 56 35-01, 1 1/4" outer thread 1/2" inner thread, 230 V

966 56 35-02, 1 1/4" outer thread 1/2" inner thread, 110 V

110 V – £ 1,215.40

230 V – £ 1,266.90

9.3 kW at 40 l/min

Hydraulic

—

—

—

6

120/230/340/580/980/1,400

Not applicable

0-650

—

—

1 1/4" 7 UNC/CR 128

—

R 1/2"

—

—

16.0

40

140

PP 325 E,

DS 900

W 70 P

—

—

—

965 15 82-07, 1 1/4" 7 UNC spindle

£ 4,170.47

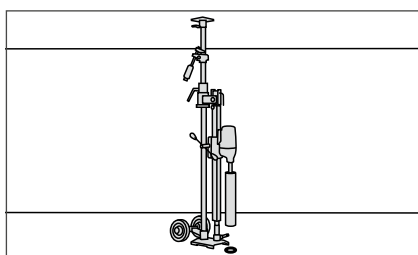

Drilling for water evacuation.

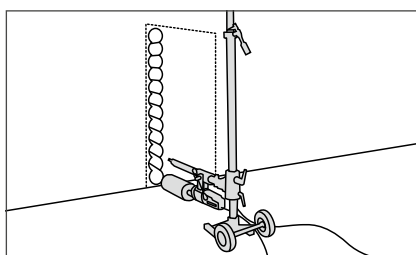

Stitch drilling.

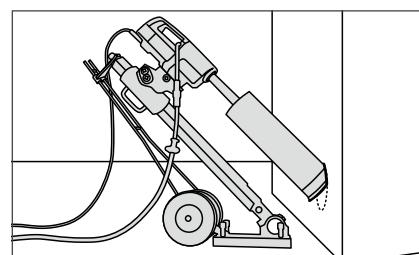

Angle drilling.

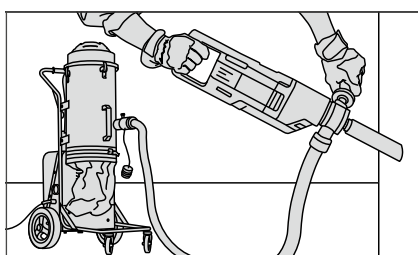

Dry drilling handheld.

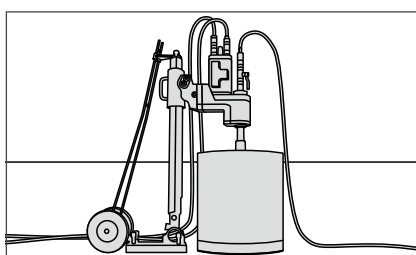

Large diameters and deep holes.

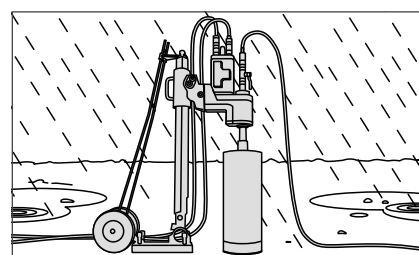

Drilling in difficult locations.



1 Anchoring kit, incl large nut, holding screw, pointer and 5 anchors



2 Anchoring systems, for anchoring in abrasive materials



3 Large selection of adapter drill bits to suit various threads



4 Washer quick release, to release the drill motor thread from the drill bit



5 Extension drill bits, for deep drilling with standard drill bits



6 Drill snap makes it easy to knock the drill out of the hole



7 Quick spacer



8 Ring adapter



9 WT 15- battery-powered water tank



10 Pressurised water tank holds 13.3 litres and comes with a 3-meter hose



11 Dust extraction adapter



12 Telescopic start help device, for an easy and safe start For DM 230



13 Telescopic start help device, for an easy and safe start For DM 220



14 Spare front handle for DM 230, designed for a good user comfort



15 Spare front handle for DM 220, designed for a good user comfort



16 Drill motor keys

Husqvarna DM 650.

ACCESSORIES		RRP	EXC	VAT
1	Anchoring kit, incl. 5 expanders	502 43 48-01	£ 73.08	
2	Anchoring system, 1 m	502 43 49-01	£ 91.39	
2	Anchoring system, 1.5 m	502 43 50-01	£ 115.95	
3	Adapter drill bit, 1 1/4" F - 1/2" G F	543 04 64-26	£ 27.06	
4	Washer quick release	543 05 28-78	£ 70.95	
5	Extension drill bit, 300 mm, 1 1/4" F - 1 1/4" M, steel	543 04 65-02	£ 57.27	
5	Extension drill bit, 500 mm, 1 1/4" F - 1 1/4" M, steel	543 04 65-04	£ 45.45	
5	Extension drill bit, 1,000 mm, 1 1/4" F - 1 1/4" M, steel	543 04 65-05	£ 144.76	
6	Drill snap, 1 1/4"	531 07 46-74	£ 76.15	
7	Quick spacer	579 50 10-01	£ 200.03	
9	Water pump, WT 15, 230 V	966 70 83-04	£ 306.90	
10	Pressurised water tank	506 32 63-02	£ 53.31	
	Expanders for anchoring, 50 pcs	502 43 54-01	£ 42.96	
	Spacer, 200 mm	586 87 99-01	£ 389.00	

SPARE PARTS		RRP	EXC	VAT
16	Drill motor keys, 32 mm	531 14 09-52	£ 24.16	

Husqvarna DM 340 and DM 280.

ACCESSORIES		RRP	EXC	VAT
1	Anchoring kit, incl. 5 expanders	502 43 48-01	£ 73.08	
2	Anchoring system, 1 m	502 43 49-01	£ 91.39	
2	Anchoring system, 1.5 m	502 43 50-01	£ 115.95	
3	Adapter drill bit, 1 1/4" F - 1/2" G F	543 04 64-26	£ 27.06	
4	Washer quick release	543 05 28-78	£ 70.95	
5	Extension drill bit, 1,000 mm, 1 1/4" F - 1 1/4" M, steel	543 04 65-05	£ 144.76	
5	Extension drill bit, 500 mm, 1 1/4" F - 1 1/4" M, steel	543 04 65-04	£ 45.45	
5	Extension drill bit, 300 mm, 1 1/4" F - 1 1/4" M, steel	543 04 65-02	£ 57.27	
6	Drill snap, 1 1/4"	531 07 46-74	£ 76.15	
7	Quick spacer	579 50 10-01	£ 200.03	
9	Water pump, WT 15, 230 V	966 70 83-04	£ 306.90	
10	Pressurised water tank	506 32 63-02	£ 53.31	
	AD 10	966 66 66-02	£ 1,432.44	
	Expanders for anchoring, 50 pcs	502 43 54-01	£ 42.96	

Husqvarna DM 230.

ACCESSORIES		RRP	EXC	VAT
1	Anchoring kit, incl. 5 expanders	502 43 48-01	£ 73.08	
2	Anchoring system, 1.5 m	502 43 50-01	£ 115.95	
2	Anchoring system, 1 m	502 43 49-01	£ 91.39	
3	Adapter drill bit, 1/2" G M - 1/2" G M	586 17 17-01	£ 11.95	
4	Washer quick release	543 05 28-78	£ 70.95	
5	Extension drill bit, 100 mm, 1/2" G M - 1/2" G F	543 04 62-99	£ 33.63	
5	Extension drill bit, 500 mm, 1/2" G M - 1/2" G F	543 04 65-00	£ 68.83	
6	Drill snap, 1 1/4"	531 07 46-74	£ 76.15	
8	Ring adapter	581 25 71-01	£ 60.66	
9	Water pump, WT 15, 230 V	966 70 83-04	£ 306.90	
10	Pressurised water tank	506 32 63-02	£ 53.31	
11	Dust extraction adapter, 1/2" G M - 1 1/4" M	543 07 70-61	£ 151.07	
12	Telescopic start help device	522 93 50-01	£ 56.34	
	Expanders for anchoring, 50 pcs	502 43 54-01	£ 42.96	

SPARE PARTS		RRP	EXC	VAT
14	Front handle	504 04 47-01	£ 99.46	
16	Drill motor keys, 32 mm	531 14 09-52	£ 24.16	
16	Drill motor keys, 24 mm	531 14 09-51	£ 3.71	
	Transport box	502 29 45-01	£ 209.46	

Husqvarna DM 220.

ACCESSORIES		RRP	EXC	VAT
1	Anchoring kit, incl. 5 expanders	502 43 48-01	£ 73.08	
2	Anchoring system, 1.5 m	502 43 50-01	£ 115.95	
2	Anchoring system, 1 m	502 43 49-01	£ 91.39	
3	Adapter drill bit, 1/2" G M - 1/2" G M	586 17 17-01	£ 11.95	
4	Washer quick release	543 05 28-78	£ 70.95	
5	Extension drill bit, 100 mm, 1/2" G M - 1/2" G F	543 04 62-99	£ 33.63	
5	Extension drill bit, 500 mm, 1/2" G M - 1/2" G F	543 04 65-00	£ 68.83	
6	Drill snap, 1 1/4"	531 07 46-74	£ 76.15	
9	Water pump, WT 15, 230 V	966 70 83-04	£ 306.90	
10	Pressurised water tank	506 32 63-02	£ 53.31	
13	Telescopic start help device	522 93 50-01	£ 56.34	
	Expanders for anchoring, 50 pcs	502 43 54-01	£ 42.96	

SPARE PARTS		RRP	EXC	VAT
15	Front handle	504 04 47-01	£ 99.46	
	Transport box	502 29 45-01	£ 209.46	

Husqvarna DM 406 H.

ACCESSORIES		RRP	EXC	VAT
1	Anchoring kit, incl. 5 expanders	502 43 48-01	£ 73.08	
2	Anchoring system, 1 m	502 43 49-01	£ 91.39	
2	Anchoring system, 1.5 m	502 43 50-01	£ 115.95	
3	Adapter drill bit, 1 1/4" F - 1/2" G F	543 04 64-26	£ 27.06	
4	Washer quick release	543 05 28-78	£ 70.95	
5	Extension drill bit, 300 mm, 1 1/4" F - 1 1/4" M, steel	543 04 65-02	£ 57.27	
5	Extension drill bit, 500 mm, 1 1/4" F - 1 1/4" M, steel	543 04 65-04	£ 45.45	
5	Extension drill bit, 1,000 mm, 1 1/4" F - 1 1/4" M, steel	543 04 65-05	£ 144.76	
6	Drill snap, 1 1/4"	531 07 46-74	£ 76.15	
7	Quick spacer	579 50 10-01	£ 200.03	
9	Water pump, WT 15, 230 V	966 70 83-04	£ 306.90	
10	Pressurised water tank	506 32 63-02	£ 53.31	
	Expanders for anchoring, 50 pcs	502 43 54-01	£ 42.96	
	Spacer, 200 mm	586 87 99-01	£ 389.00	

**TAKE CARE OF CONCRETE
DUST AND SLURRY IN A SMART
EASY AND EFFICIENT WAY!**

SEE THE SYSTEMS GUIDE ON PAGE 68



DRILL STANDS	DS 900	DS 450
TECHNICAL SPECIFICATIONS		
Recommended max drill diameter, mm	900	450
Travel, max mm	950	648
Length, telescopic stanchion, m	—	—
Pivoting	—	—
Angling	0–60°	0–60°
Weight, incl. carriage, kg	24.0	24.0
RECOMMENDED EQUIPMENT		
Drill motor	DM 650, DM 406 H	DM 340, DM 280
ARTICLE INFORMATION		
	967 30 16-02	966 82 98-07
RRP EXC VAT		
	£ 3,502.00	£ 1,557.36



AUTOMATIC DRILLING	AD 10
TECHNICAL SPECIFICATIONS	
Speed, m /min	0–3.2 in both directions
Weight, kg	3.6
RECOMMENDED EQUIPMENT	
Drill motors	DM 340, DM 280
Drill stands	DS 450, DS 50 Gyro
ARTICLE INFORMATION	
	966 66 66-01, 230 V
	967 66 66-02, 110 V
RRP EXC VAT	
	230 V - £ P0A
	110V - £ 1 432,44





DS 50 GYRO	DS 250	DS 150
350	250	150
670	685	495
3.1	—	—
Continuously adjustable	—	—
+/- 90°	0-60°	0-60°
56.0	16.0	15.5
DM 340, DM 280	DM 280, DM 230, DM 220	DM 230
965 15 78-20, incl. baseplate 50 AT 965 15 78-21, excl. baseplate 50 AT 965 15 78-22, extended, excl. baseplate 50 AT	966 82 73-01, EU-RoW	966 82 72-01
£ 4,400.32 £ POA £ POA	£ 733.36	£ 504.70



Slurry rings.

VARIANT DESCRIPTION, MM	ARTICLE DESCRIPTION	PRODUCT NUMBER	RRP EXC VAT
WSR 100	Water retention ring	593 56 30-01	£ 155.00
WSR 150	Water retention ring	593 56 30-02	£ 165.00
WSR 200	Water retention ring	593 56 30-03	£ 215.00
WSR 250	Water retention ring	593 56 30-04	£ 229.00
WSR 300	Water retention ring	593 56 30-05	£ 322.00
WSR 350	Water retention ring	593 56 30-06	£ 359.00
DS 100	Sealing disc with scale for WSR 100	593 56 34-01	£ 33.00
DS 150	Sealing disc with scale for WSR 150	593 56 34-02	£ 36.00
DS 200	Sealing disc with scale for WSR 200	593 56 34-03	£ 42.00
DS 250	Sealing disc with scale for WSR 250	593 56 34-04	£ 50.00
DS 300	Sealing disc with scale for WSR 300	593 56 34-05	£ 59.00
DS 350	Sealing disc with scale for WSR 350	593 56 34-06	£ 68.00

The AD 10 makes drilling faster and easier, so the operator can produce more in a shorter time, and with less strain. This outstanding automatic drill system optimizes the feed rate to the drill motor being used, for highly efficient and precise operation. With a single control, the operator can easily adjust speed, direction and power.



1 Stand kit excl column for DS 900



2 2-meter column for DS 900



3 2-meter column for DS 450



4 Vacuum pump with powerful electric motor and tubular-shaped tank



5 Anchoring kit, incl large nut, holding screw, pointer and 5 anchors



6 Vacuum plate



7 Vacuum gasket



8 Anchoring systems for anchoring in abrasive materials



9 Quick spacer

The automatic drill system AD 10 makes drilling more effective and less strenuous



12 Wheel kit



11 Ring adapter



13 Long back support

Husqvarna DS 900 and DS 450.

ACCESSORIES		RRP	EXC VAT
1	Stand kit excl. column (DS 900)	586 90 51-01	£ 2,925.00
2	2-meter column (DS 900)	531 11 30-46	£ 961.02
3	2-meter column (DS 450)	525 85 76-02	£ 428.66
4	Vacuum pump, VP 200	544 92 90-01	£ 561.35
5	Anchoring kit, incl. 5 expanders	502 43 48-01	£ 73.08
6	Vacuum plate	541 40 50-93	£ 144.27
8	Anchoring system, 1.5 m	502 43 50-01	£ 115.95
8	Anchoring system, 1 m	502 43 49-01	£ 91.39
9	Quick spacer	579 50 10-01	£ 200.03
10	AD 10 adapter (DS 900/DM 340)	586 74 84-01	£ 152.62
11	Ring adapter	581 25 71-01	£ 60.66
12	Wheel kit (DS 900)	587 08 81-01	£ 340.53
12	Wheel kit (DS 450)	541 40 50-83	£ 120.20
13	Long back support (DS 900)	582 87 29-01	£ 789.02
14	AD 10	966 66 66-02	£ 1,432.44
	Expanders for anchoring, 50 pcs	502 43 54-01	£ 42.96

SPARE PARTS		RRP	EXC VAT
18	3 spoke handle	541 40 50-39	£ 50.69

Husqvarna DS 250 and DS 150.

ACCESSORIES		RRP	EXC VAT
4	Vacuum pump, VP 200	544 92 90-01	
5	Anchoring kit, incl. 5 expanders	502 43 48-01	
8	Anchoring system, 1 m	502 43 49-01	
8	Anchoring system, 1.5 m	502 43 50-01	
11	Ring adapter for DS 250	581 25 71-01	
	Expanders for anchoring, 50 pcs	502 43 54-01	
	Male fitting	541 40 40-71	
	Wheelbase	541 40 50-89	

SPARE PARTS		RRP	EXC VAT
7	Vacuum gasket	578 93 21-01	
	Vacuum cap	541 40 49-04	



Husqvarna DS 50 Gyro.

ACCESSORIES		RRP	EXC VAT
9	Spacer for quick mounting	579 50 10-01	£ 200.03
11	Ring adapter	581 25 71-01	£ 60.66
14	AD 10	966 66 66-01	£ 1.432.44
15	Anchor support	544 96 60-01	£ 124.39
16	Extension pole, inner	506 40 05-03	£ 110.91
16	Extension pole, outer	506 40 85-05	£ 110.91
17	Offset arm	544 96 96-01	£ 1.093.98
18	Stop ring	544 14 02-01	£ 46.61
18	Stop rubber foot	544 96 69-01	£ 72.54
	Back support	506 40 76-10	£ 601.41
	Top support	506 40 84-01	£ 160.95

SPARE PARTS		RRP	EXC VAT
19	3 spoke handle	541 40 50-39	£ 50.69
20	Tool kit, incl. in standard package	506 40 86-01	£ 215.95

14 Automatic drill system AD 10



15 Angled anchor support



16 Extension pole, to increase the capacity of drill rig



17 Offset arm, for drilling in confined spaces



18 To facilitate angle drilling and for measuring drill depth: stop rubber foot and stop ring



19 3 spoke handle



20 Tool kit



Husqvarna DMS 240.

DRILL MOTORS WITH STAND	DMS 240
TECHNICAL SPECIFICATIONS	
Power, W	2.400
Motor	1-phase, electric
Voltage, V	230/110
Spindle speed unloaded, rpm	390/890
Spindle speed loaded, rpm	280/640
Drill connection	1 1/4" 7 UNC
Drill diameter, max mm	250
Travel, max mm	685
Column height, mm	1.000
Total weight, kg	20.4
Sound pressure level, dB (A)	99
Sound power level, dB (A)	106
Sound pressure level, dB (A)	98
Sound power level, dB (A)	113
Weight, kg	14.0
TRANSFORMER AND GENERATOR INFORMATION	
Minimum transformer size, VA	3.000, 3.690 with VP 200
Transformer Continuous or Intermittent	Continuous
Minimum generator required, k VA	7.2, 9.0 with VP 200
ARTICLE INFORMATION	
	965 17 36-03, 230 V
	965 17 36-02, 110 V
RRP EXC VAT	110 V - £ 1,915.80 230 V - £ 1,967.30

ACCESSORIES		RRP EXC VAT
1	Adapter drill bit, 1 1/4" F - 1/2" G F	543 04 64-26 £ 27.06
2	Extension drill bit, 300 mm, 1 1/4" F - 1 1/4" M, steel	543 04 65-02 £ 57.27
2	Extension drill bit, 500 mm, 1 1/4" F - 1 1/4" M, steel	543 04 65-04 £ 45.45
2	Extension drill bit, 1.000 mm, 1 1/4" F - 1 1/4" M, steel	543 04 65-05 £ 144.76
3	Dust extraction adapter, 1/2" G M - 1 1/4" M	543 07 70-61 £ 151.07
4	Washer quick release	543 05 28-78 £ 119.00
5	Drill snap 1 1/4"	531 07 46-74 £ 76.15
6	Anchoring kit, incl. 5 expanders	502 43 48-01 £ 73.08
7	Anchoring system 1 m	502 43 49-01 £ 91.39
7	Anchoring system 1.5 m	502 43 50-01 £ 115.95
10	Water pump, WT 15, 230 V	966 70 83-01 £ 306.90
11	Pressurised water tank	506 32 63-02 £ 53.31
12	Vacuum pump, VP 200	544 92 90-01 £ 561.35
	Expanders for anchoring, 50 pcs	502 43 54-01 £ 42.96



PRIME



POWER UNITS	PP 490	PP 65	PP 325 E	PP 518
TECHNICAL SPECIFICATIONS				
Power output, kW	20	7/4	9.3	10.4
Rated current, A	32/25/16 reduced	16/16 (3-phase/1-phase)	16	—
Voltage, V	400	200-240	400	Petrol-powered
Pressure, bar	—	—	140	140
Flow, l/min	—	—	40	20, 30, 40
Weight incl. oil, kg	25	9.5	95.0	145.0 incl. oil and hoses
RECOMMENDED EQUIPMENT				
	WS 482 HF, WS 440 HF, CS 10 (together with WS 482 HF or WS 440 HF) K 6500, K 6500 Ring, K 6500 Chain, DM 650	DM 650, K 6500, K 6500 Ring	DM 406 H, K 3600 MK II, K 2500	DM 406 H, K 3600 MK II, K 2500
ARTICLE INFORMATION				
	967 64 98-01, PP 490, 380-400 V, 5 pin For accessories see page 81	966 56 37-01	965 15 64-04, 400 V, 4 pin SoftStart™	967 15 36-02, incl. hydraulic hose set, 1/2"×7.6 m
RRP EXC VAT	£ POA	£ 3,502.00	£ 4,964.18	£ 4,987.26



1 Large selection of adapters to suit various threads



2 Extensions for deep drilling with standard drill bits



3 Dust extraction adapter



4 Washer quick release



5 Drill snap



6 Anchoring kit, incl large nut, holding screw, pointer and 5 anchors



7 Anchoring systems for DMS 240



8 Anchoring systems for DMS 160 AT and DMS 160 A



9 Small-diameter vacuum plate for DMS 160 AT and DMS 160 A



10 WT 15 battery-powered water tank



11 Pressurised water tank holds 13.3 litres and comes with a 3-meter hose



12 Vacuum pump with powerful electric motor and tubular-shaped tank



14 Tool kit for DMS 160 AT and DMS 160 A



15 Gardena-Tema water adapter



16 Power cable



17 Power harness adapter



18 Hydraulic oil filter



19 Water hose connection



20 Hydraulic hose set

Husqvarna PP 65.

SPARE PARTS	RRP	EXC	VAT
15 Gardena-Tema water adapter	585 56 41-01	£ 37.73	
16 Main power cable	578 37 23-01	£ 986.59	
17 Power harness adapter	579 00 23-01	£ 55.00	

Husqvarna PP 325 E.

SPARE PARTS	RRP	EXC	VAT
18 Hydraulic oil filter	531 11 82-49	£ 71.90	
19 Water hose connection	510 20 30-01	£ 30.06	

Husqvarna PP 518.

SPARE PARTS	RRP	EXC	VAT
20 Hydraulic hose set, 1/2" x 7.6 m	510 20 23-06	£ 534.14	
20 Hydraulic hose set, 5/8" x 7.6 m	510 20 23-08	£ 825.14	
20 Hydraulic hose, 5/8" x 15.2 m	510 20 23-10	£ 1.058.01	
Replacement battery, 12 V	522 95 02-01	£ 98.00	

Slurry rings.

Explore our range of slurry rings and information on the right machine/ring combinations on page 115

DIAMOND TOOLS FOR DRILLING

With more than 70 years of experience, Husqvarna continues to develop state-of-the-art diamond drill bits for professionals and frequent users. Our drill bit range consists of four series. The D 1400 Elite-Drill is available with the revolutionary Diagrip™ technology, where the diamonds are specially treated to be distributed optimally and remain in place in the segments longer.

The Vari-Drill series are laser-welded, high performance tools, which provides durability and a free cutting performance whereas the D 600 series is designed for drilling in tiles. Tacti-Drill series are reliable, laser-welded bits with a high purchasing value for non-intensive use in heavier applications.

Revolutionary diamond tool technology for great cutting capacity and durability.

One of the greatest benefits with the Diagrip™ technology is how fast and smooth the diamond tools go through all types of construction materials. Diagrip™ tools means trouble-free drilling, especially in heavily reinforced concrete.

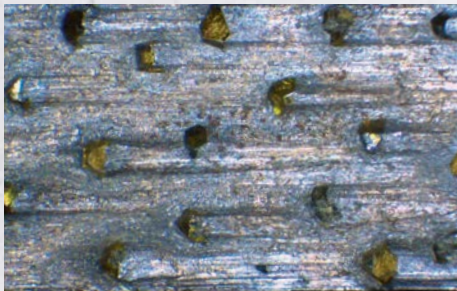

The diamonds are specially treated to remain in place in the segments longer, and be distributed optimally, delivering maximum efficiency to every diamond. With Diagrip™ the diamonds are exposed and expended at an even rate, which makes the edge very even and powerful, even when cutting hard materials like reinforced concrete.



See page 16 for more information.



ELITE-DRILL

PRODUCT	ELITE-DRILL			
	D 1405	D 1410	D 1420	D 1425
SEGMENT SHAPE				
MATERIAL				
Tiles	—	—	—	—
Natural stone, granite	●●●	●●	●	—
Concrete, hard	●●●	●●●	●●	—
Concrete, medium	●●	●●	●●●	●●●
Concrete, soft	—	—	●●	●●●
Concrete, abrasive	—	—	—	●●
Asphalt	—	—	—	—
Brick	—	—	—	—
Cement blocks	—	—	—	—
RECOMMENDED EQUIPMENT				
Drill motor	DM 650, DM 406 H, DM 340, DM 280, DMS 240			

●●● = Optimal ●● = Good ● = Acceptable — = Not recommended



VARI-DRILL



TACTI-DRILL



D 810



D 05



D 25

VARI-DRILL	TACTI-DRILL	D 810	D 05	D 25
D 20	D 20	D 810	D 05	D 25
-	-	-	•••	-
•••	••	•••	•••	•
•••	•••	••	•	•••
••	•••	••	•	•••
•	••	••	•	•••
-	•	•	•	••
-	•	•	•	•
-	•	••	•	•••
-	•	••	•	•••
DM 650, DM 406 H, DM 340, DM 280, DMS 240			DM 280, DM 230, DM 220, DMS 240, DMS 160 AT/A	DM 230, DM 220, DMS 160 AT/A

Husqvarna Elite-Drill D 1405.

Gold level drill bit with Diagrip™ technology for easy drilling in hard concrete.
For motors from 2.4 kW and up. 500 mm core length as standard.

DIAMETER. MM	SEGMENT DIMENSIONS. MM (L×W×H)	NUMBER OF SEGMENTS	PRODUCT NUMBER CONNECTOR 1 1/4"	RRP EXC VAT
52	24.0×3.5×9.0+2	5	582 06 29-03	£ 103.89
62	24.0×3.5×9.0+2	6	582 06 30-03	£ 140.88
72	24.0×3.5×9.0+2	6	582 06 31-03	£ 147.99
77	24.0×3.5×9.0+2	6	590 49 46-02	£ 181.62
82	24.0×3.5×9.0+2	7	582 18 62-03	£ 147.99
87	24.0×3.5×9.0+2	7	582 18 63-03	£ 159.58
102	24.0×3.5×9.0+2	8	582 18 93-03	£ 162.61
107	24.0×3.5×9.0+2	9	582 18 94-03	£ 153.52
112	24.0×3.5×9.0+2	9	582 18 95-03	£ 194.93
122	24.0×3.5×9.0+2	10	582 18 96-03	£ 211.09
127	24.0×3.5×9.0+2	10	582 18 97-03	£ 216.00
132	24.0×3.5×9.0+2	11	582 06 32-03	£ 234.32
142	24.0×3.5×9.0+2	11	582 18 98-03	£ 243.41
152	24.0×4.0×9.0+2	12	582 19 51-03	£ 218.16
162	24.0×4.0×9.0+2	12	582 19 52-03	£ 269.67
172	24.0×4.0×9.0+2	13	582 19 53-03	£ 289.87
182	24.0×4.0×9.0+2	13	582 19 54-03	£ 312.09
200	24.0×4.0×9.0+2	14	582 19 55-03	£ 333.34
225	24.0×4.0×9.0+2	15	582 19 56-03	£ 439.35
250	24.0×4.5×9.0+2	16	582 19 57-03	£ 459.55
300	24.0×4.5×9.0+2	18	582 19 58-03	£ 530.25
350	24.0×4.5×9.0+2	21	582 19 59-03	£ 570.27

Other diameters available on request.

Husqvarna Elite-Drill D 1410.

Gold level drill bit with Diagrip™ technology for easy drilling at high speeds.
For motors from 2.4 kW and up. 500 mm core length as standard.

DIAMETER. MM	SEGMENT DIMENSIONS. MM (L×W×H)	NUMBER OF SEGMENTS	PRODUCT NUMBER CONNECTOR 1 1/4"	RRP EXC VAT
82	24.0×4.0×9.0+4	8	585 20 98-02	£ 147.99
87	24.0×4.0×9.0+4	9	585 21 01-02	£ 159.58
102	24.0×4.0×9.0+4	9	585 21 02-02	£ 162.61
107	24.0×4.0×9.0+4	10	585 21 04-02	£ 153.52
112	24.0×4.0×9.0+4	10	585 21 05-02	£ 194.93
122	24.0×4.0×9.0+4	11	585 21 06-02	£ 211.09
127	24.0×4.0×9.0+4	12	585 21 08-02	£ 191.90
132	24.0×4.0×9.0+4	12	585 21 10-02	£ 234.32
142	24.0×4.0×9.0+4	12	585 21 12-02	£ 243.41
152	24.0×4.5×9.0+4	13	585 21 13-02	£ 218.16
162	24.0×4.5×9.0+4	13	585 21 14-02	£ 269.67
172	24.0×4.5×9.0+4	14	585 21 16-02	£ 289.87
182	24.0×4.5×9.0+4	14	585 21 18-02	£ 312.09
192	24.0×4.5×9.0+4	15	585 21 20-02	£ 312.12
200	24.0×4.5×9.0+4	15	585 21 21-02	£ 325.22
225	24.0×4.5×9.0+4	16	585 21 24-02	£ 439.35
250	24.0×4.5×9.0+4	17	585 21 28-02	£ 459.55
275	24.0×4.5×9.0+4	19	585 27 88-02	£ 494.90
300	24.0×4.5×9.0+4	19	585 21 32-02	£ 530.25
350	24.0×4.5×9.0+4	22	585 21 34-02	£ 563.58
400	24.0×4.5×9.0+4	26	586 07 78-01	£ 671.91
650	24.0×4.5×9.0+4	40	586 50 15-02	£ 1,131.68

Other diameters available on request.

Husqvarna Elite-Drill D 1420.

Gold level drill bit with Diagrip™ technology for durability in tough conditions.
For motors from 2.4 kW and up. 500 mm core length as standard.

DIAMETER. MM	SEGMENT DIMENSIONS. MM (L×W×H)	NUMBER OF SEGMENTS	PRODUCT NUMBER CONNECTOR 1 1/4"	RRP EXC VAT
52	24.0×3.5×9.0+2	5	586 08 35-02	£ 103.89
62	24.0×3.5×9.0+2	6	586 08 37-02	£ 140.88
72	24.0×3.5×9.0+2	6	586 08 41-02	£ 147.99
82	24.0×4.0×9.0+2	7	586 08 45-02	£ 147.99
87	24.0×4.0×9.0+2	7	586 08 46-01	£ 158.00
92	24.0×4.0×9.0+2	8	586 08 48-02	£ 159.58
102	24.0×4.0×9.0+2	8	586 08 50-02	£ 162.61
107	24.0×4.0×9.0+2	9	586 08 51-02	£ 153.52
112	24.0×4.0×9.0+2	9	586 08 52-02	£ 194.93
122	24.0×4.0×9.0+2	10	586 08 55-02	£ 211.09
127	24.0×4.0×9.0+2	10	586 08 57-02	£ 191.90
132	24.0×4.0×9.0+2	11	586 08 59-02	£ 234.32
142	24.0×4.0×9.0+2	11	586 08 61-02	£ 243.41
152	24.0×4.5×9.0+2	12	586 08 63-02	£ 218.16
162	24.0×4.5×9.0+2	12	586 08 64-02	£ 269.67
172	24.0×4.5×9.0+2	13	586 08 67-02	£ 289.87
182	24.0×4.5×9.0+2	13	586 08 70-02	£ 312.09
200	24.0×4.5×9.0+2	14	586 08 75-02	£ 325.22
225	24.0×4.5×9.0+2	15	586 08 81-02	£ 439.35
250	24.0×4.5×9.0+2	16	586 08 84-02	£ 459.55
275	24.0×4.5×9.0+2	18	586 08 88-02	£ 494.90
300	24.0×4.5×9.0+2	18	586 08 90-02	£ 530.25
350	24.0×4.5×9.0+2	21	586 08 95-02	£ 563.58
400	24.0×4.5×9.0+2	24	586 08 99-01	£ 650.44
425	24.0×4.5×9.0+2	26	586 09 00-01	£ 719.12
450	24.0×4.5×9.0+2	26	586 09 01-01	£ 787.80
500	24.0×4.5×9.0+2	30	586 09 02-01	£ 893.85
550	24.0×4.5×9.0+2	32	586 09 04-01	£ 969.60
600	24.0×4.5×9.0+2	32	586 09 06-01	£ 1,035.25
650	24.0×4.5×9.0+2	36	586 09 07-01	£ 1,181.70
700	24.0×4.5×9.0+2	38	586 09 08-01	£ 1,414.00
800	24.0×4.5×9.0+2	40	586 09 09-01	£ 1,504.90
900	24.0×4.5×9.0+2	40	586 80 22-01	£ 1,660.44

Other diameters available on request.

Husqvarna Elite-Drill D 1425.

Gold level Diagrip™ drill bit with high durability in high reinforced concrete. 500 mm core length as standard.

DIAMETER. MM	SEGMENT DIMENSIONS. MM (L×W×H)	NUMBER OF SEGMENTS	PRODUCT NUMBER CONNECTOR 1 1/4"	RRP EXC VAT
52	24.0×3.5×9.0+2	5	591 14 07-02	£ 103.89
62	24.0×3.5×9.0+2	6	591 14 09-02	£ 140.88
72	24.0×3.5×9.0+2	6	591 14 11-02	£ 147.99
82	24.0×3.5×9.0+2	7	591 14 13-02	£ 147.99
92	24.0×3.5×9.0+2	7	592 88 11-01	£ 159.58
102	24.0×3.5×9.0+2	8	591 14 15-02	£ 162.61
107	24.0×3.5×9.0+2	9	591 14 16-02	£ 153.52
112	24.0×3.5×9.0+2	9	591 14 17-02	£ 194.93
122	24.0×3.5×9.0+2	10	591 14 18-02	£ 211.09
127	24.0×3.5×9.0+2	10	591 14 19-02	£ 211.14
132	24.0×3.5×9.0+2	11	591 14 20-02	£ 234.32
142	24.0×3.5×9.0+2	11	591 1421-02	£ 243.41
152	24.0×3.5×9.0+2	12	591 14 22-02	£ 218.16
162	24.0×4.0×9.0+2	12	591 14 23-02	£ 269.67
172	24.0×4.0×9.0+2	13	591 14 24-02	£ 289.87
182	24.0×4.0×9.0+2	13	591 14 25-02	£ 312.09
200	24.0×4.0×9.0+2	14	591 14 26-02	£ 370.34
225	24.0×4.0×9.0+2	15	591 14 28-02	£ 439.35
250	24.0×4.0×9.0+2	16	591 14 29-02	£ 459.55
300	24.0×4.0×9.0+2	18	591 14 30-02	£ 530.25
350	24.0×4.0×9.0+2	21	591 14 31-02	£ 640.90

Other diameters available on request.

Husqvarna Vari-Drill D 20.

Silver level drill bit for heavy-duty applications when working with medium to hard concrete. For 1.5–4 kW motors.

DIAMETER, MM	CONNECTOR	TUBE LENGTH, MM	SEGMENT DIMENSIONS, MM (L×W×H)	NUMBER OF SEGMENTS	PRODUCT NUMBER	RRP EXC VAT
52	1 1/4"	450	24.0×3.5×9.0+2	5	582 00 51-01	£ 77.36
57	1 1/4"	450	24.0×3.5×9.0+2	5	582 00 52-01	£ 83.71
62	1 1/4"	450	24.0×3.5×9.0+2	6	582 00 53-01	£ 85.20
72	1 1/4"	450	24.0×3.5×9.0+2	6	582 00 54-01	£ 96.41
82	1 1/4"	450	24.0×3.5×9.0+2	7	582 00 55-01	£ 107.63
87	1 1/4"	450	24.0×3.5×9.0+2	7	582 00 56-01	£ 112.48
102	1 1/4"	450	24.0×3.5×9.0+2	8	582 00 57-01	£ 123.69
107	1 1/4"	450	24.0×3.5×9.0+2	9	582 00 58-01	£ 140.51
112	1 1/4"	450	24.0×3.5×9.0+2	9	582 00 59-01	£ 148.36
122	1 1/4"	450	24.0×3.7×9.0+2	10	582 00 60-01	£ 156.58
132	1 1/4"	450	24.0×3.7×9.0+2	11	582 00 61-01	£ 167.79
152	1 1/4"	450	24.0×3.7×9.0+2	12	582 00 62-01	£ 179.38
162	1 1/4"	450	24.0×4.0×9.0+2	12	582 00 63-01	£ 186.85
172	1 1/4"	450	24.0×4.0×9.0+2	13	582 00 64-01	£ 200.68
182	1 1/4"	450	24.0×4.0×9.0+2	13	582 00 65-01	£ 214.50
200	1 1/4"	450	24.0×4.0×9.0+2	14	582 00 66-01	£ 239.17
225	1 1/4"	450	24.0×4.3×9.0+2	16	582 00 67-01	£ 302.70
250	1 1/4"	450	24.0×4.3×9.0+2	17	582 00 68-01	£ 330.35
300	1 1/4"	450	24.0×4.3×9.0+2	21	582 00 69-01	£ 412.56

Husqvarna Tacti-Drill D 20.

Bronze level drill bit for high speed and free cutting. For 1.5–4 kW motors.

DIAMETER, MM	CONNECTOR	TUBE LENGTH, MM	SEGMENT DIMENSIONS, MM (L×W×H)	NUMBER OF SEGMENTS	PRODUCT NUMBER	RRP EXC VAT
52	1 1/4"	450	24.0×3.5×7.0+2	5	582 07 69-01	£ 63.90
57	1 1/4"	450	24.0×3.5×7.0+2	5	582 07 70-01	£ 65.02
62	1 1/4"	450	24.0×3.5×7.0+2	5	582 07 71-01	£ 70.26
72	1 1/4"	450	24.0×3.5×7.0+2	6	582 07 73-01	£ 81.84
82	1 1/4"	450	24.0×3.5×7.0+2	7	582 07 74-01	£ 90.44
87	1 1/4"	450	24.0×3.5×7.0+2	7	582 07 75-01	£ 96.04
102	1 1/4"	450	24.0×3.5×7.0+2	8	582 07 76-01	£ 104.64
107	1 1/4"	450	24.0×3.5×7.0+2	9	582 07 77-01	£ 115.10
112	1 1/4"	450	24.0×3.5×7.0+2	9	582 07 80-01	£ 125.56
122	1 1/4"	450	24.0×3.7×7.0+2	10	582 07 81-01	£ 131.17
132	1 1/4"	450	24.0×3.7×7.0+2	11	582 07 82-01	£ 140.14
152	1 1/4"	450	24.0×3.7×7.0+2	12	582 07 83-01	£ 151.35
162	1 1/4"	450	24.0×3.7×7.0+2	12	582 07 84-01	£ 157.33
182	1 1/4"	450	24.0×4.0×7.0+2	13	582 07 85-01	£ 180.50
200	1 1/4"	450	24.0×4.0×7.0+2	13	582 07 86-01	£ 201.42
225	1 1/4"	450	24.0×4.0×7.0+2	14	582 07 87-01	£ 256.73
250	1 1/4"	450	24.0×4.3×7.0+2	17	582 07 88-01	£ 279.90
300	1 1/4"	450	24.0×4.3×7.0+2	21	582 07 89-01	£ 392.01



Husqvarna Thin-walled D 810.

Silver level drill bit with great versatility for handheld wet cutting. For 1.5–2.5 kW motors.

DIAMETER, MM	CONNECTOR	TUBE LENGTH, MM	SEGMENT DIMENSIONS, MM (L×W×H)	NUMBER OF SEGMENTS	PRODUCT NUMBER	RRP EXC VAT
10	1/2" G	150	10.0×2.3×7.5+2	Crown	522 88 30-01	£ 58.31
12	1/2" G	150	12.0×2.3×7.5+2	Crown	522 88 31-01	£ 60.39
14	1/2" G	250	14.0×2.3×7.5+2	Crown	522 88 32-01	£ 66.64
16	1/2" G	250	16.0×2.3×7.5+2	Crown	522 88 33-01	£ 67.15
18	1/2" G	250	18.0×2.3×7.5+2	Crown	522 88 34-01	£ 67.68
20	1/2" G	350	20.0×2.3×7.5+2	Crown	522 88 35-01	£ 68.21
22	1/2" G	350	22.0×2.3×7.5+2	Crown	522 88 36-01	£ 68.72
25	1/2" G	350	25.0×2.3×7.5+2	Crown	522 88 37-01	£ 69.76
28	1/2" G	350	28.0×2.3×7.5+2	Crown	522 88 38-01	£ 70.80
30	1/2" G	350	30.0×2.3×7.5+2	Crown	522 88 39-01	£ 71.84
32	1/2" G	350	32.0×2.3×7.5+2	Crown	522 88 40-01	£ 73.93
35	1/2" G	350	35.0×2.3×7.5+2	Crown	522 88 41-01	£ 74.97
40	1/2" G	350	40.0×2.3×7.5+2	Crown	522 88 42-01	£ 83.29
42	1/2" G	350	42.0×2.3×7.5+2	Crown	574 52 67-01	£ 86.43
45	1/2" G	350	45.0×2.3×7.5+2	Crown	522 88 43-01	£ 88.51
50	1/2" G	350	50.0×2.3×7.5+2	Crown	522 88 44-01	£ 94.75



Husqvarna Vari-Drill D 25.

Silver level drill bit for dry drilling with high speed handheld drill motors. From 1 kW.

DIAMETER, MM	TUBE LENGTH, MM	SEGMENT DIMENSIONS, MM (L×W×H)	NUMBER OF SEGMENTS	PRODUCT NUMBER	RRP EXC VAT
VARI-DRILL D 25 WITH M 16 CONNECTOR AND TUBE LENGTH 150 MM					
37	150	16.0×3.0×9.0	4	586 09 96-01	£ 42.77
52	150	24.0×3.5×9.0	4	586 09 97-01	£ 45.22
57	150	24.0×3.5×9.0	4	586 09 98-01	£ 56.43
68	150	24.0×3.5×9.0	4	586 09 99-01	£ 63.90
85	150	24.0×3.5×9.0	4	586 10 00-01	£ 67.64
107	150	24.0×4.0×9.0	5	586 10 01-01	£ 71.38
VARI-DRILL D 25 WITH 1/2" GF CONNECTOR AND TUBE LENGTH 150 MM					
37	150	16.0×3.0×9.0	4	586 10 08-01	£ 44.10
52	150	24.0×3.5×9.0	4	586 10 09-01	£ 55.00
65	150	24.0×3.5×9.0	4	586 10 10-01	£ 59.79
107	150	24.0×4.0×9.0	5	586 10 11-01	£ 75.86
117	150	24.0×4.0×9.0	5	586 10 12-01	£ 79.97
127	150	24.0×4.0×9.0	6	586 10 13-01	£ 77.73
152	150	24.0×4.0×9.0	7	586 10 14-01	£ 114.20
VARI-DRILL D 25 WITH M 16 CONNECTOR AND TUBE LENGTH 62 MM					
68	62	24.0×3.5×9.0	4	586 10 16-01	£ 48.95
82	62	24.0×3.5×9.0	4	586 10 17-01	£ 52.69

Accessories Vari-Drill D 25.

TYPE	PRODUCT NUMBER	RRP EXC VAT
Adapter drill bit, conical 10 mm*, HEX - 1/2" G M	586 17 15-01	£ 5.66
Adapter drill bit, conical 10 mm*, SDS + - 1/2" G M	586 17 16-01	£ 8.64
Adapter drill bit, conical 10 mm*, 1/2" G M - 1/2" G M	586 17 17-01	£ 11.95
Adapter drill bit, conical 10 mm*, M 16 F - 1/2" G M	586 17 18-01	£ 13.04
Adapter drill bit, conical 8 mm*, HEX - M 16 M	586 17 19-01	£ 10.03
Adapter drill bit, conical 8 mm*, SDS + - M 16 M	586 17 20-01	£ 10.03
Adapter drill bit, conical 8 mm*, 1/2" G M - M 16 M	586 17 21-01	£ 14.80
Centering device + centering remover, conical 8 mm*, for M 16 length 150 mm	586 17 22-01	£ 9.20
Centering device + centering remover, conical 10 mm*, for 1/2" G M length 150 mm	586 17 23-01	£ 9.20
Centering device + centering remover, conical 8 mm*, for M 16 length 62 mm	586 17 24-01	£ 10.34
Extension drill bit, length 250 mm, M 16 F - M 16 M	586 17 25-01	£ 23.50
Extension drill bit, length 250 mm, 1/2" GF - 1/2" GM	586 17 26-01	£ 21.54

*Centering type.



Air conditioning kit Vari-Drill D 25 M 16.

Complete solutions package. Weight 6 kg.

PRODUCT NUMBER	DESCRIPTION	PIECES	PRODUCT NUMBER, KIT	RRP EXC VAT
586 09 97-01	Vari-Drill D 25 drill bit, Ø 52 mm, 150 mm, connector M 16	1	586 10 07-01	£ 248.51
586 09 98-01	Vari-Drill D 25 drill bit, Ø 57 mm, 150 mm, connector M 16	1		
586 09 99-01	Vari-Drill D 25 drill bit, Ø 68 mm, 150 mm, connector M 16	1		
586 10 00-01	Vari-Drill D 25 drill bit, Ø 85 mm, 150 mm, connector M 16	1		
586 10 01-01	Vari-Drill D 25 drill bit, Ø 107 mm, 150 mm, connector M 16	1		
586 17 22-01	Centering device	1		
586 17 19-01	Adapter drill bit, HEX - M 16 M	1		
586 17 20-01	Adapter drill bit, SDS + - M 16 M	1		
586 17 21-01	Adapter drill bit, 1/2" GM - M 16 M	1		
586 17 25-01	Extension drill bit, 250 mm, M 16 F - M 16 M	1		



Air conditioning kit Vari-Drill D 25 1/2" GF.

Complete solutions package. Weight 6 kg

PRODUCT NUMBER	DESCRIPTION	PIECES	PRODUCT NUMBER, KIT	RRP EXC VAT
586 10 08-01	Vari-Drill D 25 drill bit, Ø 37 mm, 150 mm, connector 1/2" GF	1	586 10 15-01	£ 363.60
586 10 09-01	Vari-Drill D 25 drill bit, Ø 52 mm, 150 mm, connector 1/2" GF	1		
586 10 11-01	Vari-Drill D 25 drill bit, Ø 107 mm, 150 mm, connector 1/2" GF	1		
586 10 12-01	Vari-Drill D 25 drill bit, Ø 117 mm, 150 mm, connector 1/2" GF	1		
586 10 13-01	Vari-Drill D 25 drill bit, Ø 127 mm, 150 mm, connector 1/2" GF	1		
586 17 23-01	Centering device	1		
586 17 15-01	Adapter drill bit, HEX - 1/2" G M	1		
586 17 16-01	Adapter drill bit, SDS + - 1/2" G M	1		
586 17 17-01	Adapter drill bit, 1/2" G M - 1/2" G M	1		
586 17 26-01	Extension drill bit, 250 mm, 1/2" G F - 1/2" G M	1		

Husqvarna Vari-Drill D 05.

Easy-to-use professional drill bit for ceramic and stone tiles. For motors from 650 W and angle grinders.

DIAMETER, MM	CONNECTOR	TUBE LENGTH, MM	SEGMENT DIMENSIONS, MM (L×W×H)	PRODUCT NUMBER	RRP EXC VAT
6	HEX	25	1.5×1.5	522 97 05-01	£ 18.58
8	HEX	25	1.5×1.5	522 97 07-01	£ 22.12
10	HEX	25	1.5×1.5	522 97 08-01	£ 22.42
12	HEX	25	1.5×1.5	522 97 09-01	£ 22.96
20	M 14	35	2.0×2.5	522 97 11-01	£ 38.16
27	M 14	35	2.0×2.5	522 97 12-01	£ 46.34
35	M 14	35	2.0×2.5	522 97 13-01	£ 56.80
45	M 14	35	2.0×2.5	522 97 14-01	£ 63.90
50	M 14	35	2.0×2.5	522 97 15-01	£ 71.38
55	M 14	35	2.0×2.5	522 97 16-01	£ 78.10
60	M 14	35	2.0×2.5	522 97 17-01	£ 88.57
65	M 14	35	2.0×2.5	522 97 18-01	£ 96.04

Accessories Vari-Drill D 05.

TYPE	PRODUCT NUMBER	RRP EXC VAT
Adapter drill bit M 14-HEX	575 31 73-01	£ 22.57
Centering device for diameter 5-12 mm	522 97 51-01	£ 18.35
Centering device for diameters 20-65 mm	522 97 52-01	£ 27.81



Small diameters tile kit.

Complete solutions package. For motors up to 1 kW.

PRODUCT NUMBER	DESCRIPTION	PIECES	PRODUCT NUMBER, KIT	RRP EXC VAT
522 97 04-01	Vari-Drill D05 drill bit, Ø 5 mm, 25 mm, connector HEX	1	522 97 61-01	£ 100.95
522 97 05-01	Vari-Drill D05 drill bit, Ø 6 mm, 25 mm, connector HEX	1		
522 97 06-01	Vari-Drill D05 drill bit, Ø 7 mm, 25 mm, connector HEX	1		
522 97 07-01	Vari-Drill D05 drill bit, Ø 8 mm, 25 mm, connector HEX	1		
522 97 08-01	Vari-Drill D05 drill bit, Ø 10 mm, 25 mm, connector HEX	1		
522 97 09-01	Vari-Drill D05 drill bit, Ø 12 mm, 25 mm, connector HEX	1		
522 97 51-01	Centering device for diameter 5-12 mm	1		
575 31 73-01	Adapter drill bit, HEX- M 16 M	1		



Big diameters tile kit.

Complete solutions package. For motors up to 1 kW.

PRODUCT NUMBER	DESCRIPTION	PIECES	PRODUCT NUMBER, KIT	RRP EXC VAT
522 97 11-01	Vari-Drill D05 drill bit, Ø 20 mm, 35 mm, connector M 14	1	522 97 62-01	£ 319.11
522 97 12-01	Vari-Drill D05 drill bit, Ø 27 mm, 35 mm, connector M 14	1		
522 97 13-01	Vari-Drill D05 drill bit, Ø 35 mm, 35 mm, connector M 14	1		
522 97 14-01	Vari-Drill D05 drill bit, Ø 45 mm, 35 mm, connector M 14	1		
522 97 16-01	Vari-Drill D05 drill bit, Ø 55 mm, 35 mm, connector M 14	1		
522 97 18-01	Vari-Drill D05 drill bit, Ø 65 mm, 35 mm, connector M 14	1		
522 97 52-01	Centering device for diameters 20-65 mm	1		
575 31 73-01	Adapter drill bit, HEX- M 16 M	1		



General adapters.

Large selection of adapters to suit various threads used for both dry and wet drill bits. Most threads commonly used in the drilling industry are available.

DESCRIPTION	PRODUCT NUMBER	RRP EXC VAT
FOR M 16 F BITS		
HEX Rapido – M 16 M	586 17 19-01	£ 10.03
SDS + – M 16 M	586 17 20-01	£ 10.03
1/2" G M – M 16 M	586 17 21-01	£ 14.80
FOR 1/2" G M BITS		
1 1/4" F – 1/2" G F	543 04 64-26	£ 27.06
1/2" G F – 1/2" G F	543 05 80-35	£ 29.69
Hilti L – 1 1/4" M/1/2" G F	543 08 16-29	£ 155.80
Hilti U – 1 1/4" M/1/2" G F	543 05 85-57	£ 148.18
SDS +- 1/2" G F	531 07 71-08	£ 109.72
FOR 1/2" G F BITS		
HEX – 1/2" G M	586 17 15-01	£ 5.66
SDS + – 1/2" G M	586 17 16-01	£ 8.64
1/2" G M – 1/2" G M	586 17 17-01	£ 11.95
M 16 F – 1/2" G M	586 17 18-01	£ 13.04
FOR 1 1/4" F BITS		
1/2" G M – 1 1/4" M	543 04 64-98	£ 22.33
Hilti L – 1 1/4" M/1/2" G F	543 08 16-29	£ 155.80
Hilti U – 1 1/4" M/1/2" G F	543 05 85-57	£ 148.18
FOR DUST EXTRACTION		
1/2" G M – 1 1/4" M	543 07 70-61	£ 151.07



Extensions.

These extension rods are used when deeper holes need to be drilled using standard drill bits. Available in both steel, and also aluminum for a lighter alternative.

PRODUCT NUMBER	DESCRIPTION	LENGTH, MM	MATERIAL	RRP EXC VAT
FOR 1/2" G M BITS				
543 04 62-99	1/2" G M – 1/2" G F	100	Steel	£ 33.63
543 05 73-68	1/2" G M – 1/2" G F	200	Steel	£ 16.81
543 03 71-25	1/2" G M – 1/2" G F	300	Steel	£ 39.19
543 05 73-83	1/2" G M – 1/2" G F	400	Steel	£ 46.24
543 04 65-00	1/2" G M – 1/2" G F	500	Steel	£ 68.83
FOR 1/2" G F BITS				
586 17 26-01	1/2" G M – 1/2" G M	250	Steel	£ 21.54
FOR 1 1/4" F BITS				
543 05 97-78	1 1/4" F – 1 1/4" M	100	Steel	£ 46.24
543 04 65-01	1 1/4" F – 1 1/4" M	200	Steel	£ 21.28
543 04 65-02	1 1/4" F – 1 1/4" M	300	Steel	£ 57.27
543 04 65-03	1 1/4" F – 1 1/4" M	400	Steel	£ 43.61
543 04 65-04	1 1/4" F – 1 1/4" M	500	Steel	£ 45.45
543 04 65-05	1 1/4" F – 1 1/4" M	1,000	Steel	£ 144.76
FOR DUST EXTRACTION				
543 08 08-32	1 1/4" F – 1 1/4" M	300	Steel	£ 47.82

IMAGINE YOUR FAVORITE POWER CUTTER – THEN IMAGINE IT ALWAYS GETTING BETTER

No matter how good our power cutters and diamond tools get, we never stop improving. What drives us to do this is our commitment to you, the user. We also design our products around the user, you get perfectly balanced, easy to use and lightweight machines. And we add outstanding reliability and power, so you can stay focused on getting the job done – with great results every time. To put it simply, you can always expect more from a Husqvarna.

Range overview.

Husqvarna has the widest range of handheld power cutters on the market, containing more than 20 different models, with cutting depths up to 450 mm. Regardless of your preferred power source – petrol, electric, hydraulic, pneumatic or battery – you will find the power cutter for your job here.

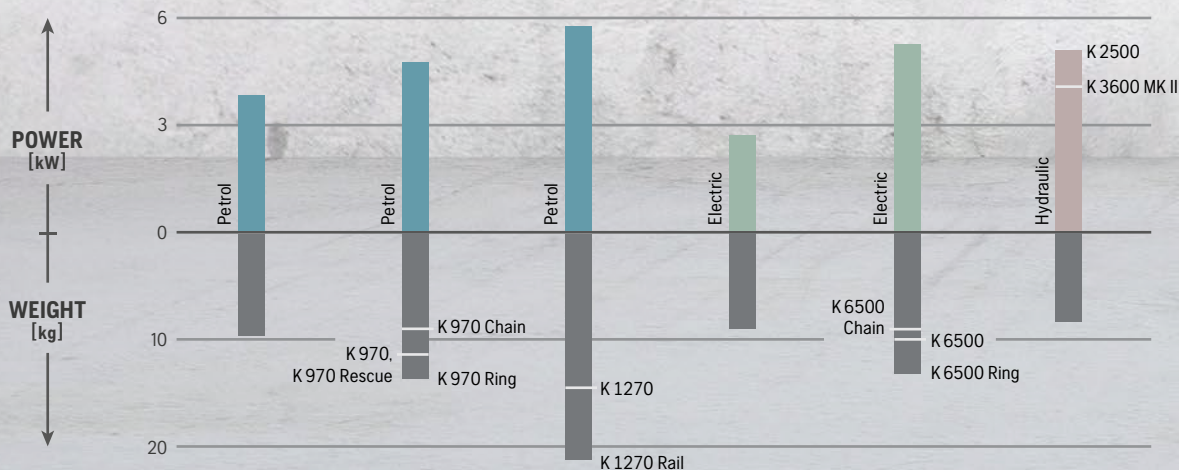
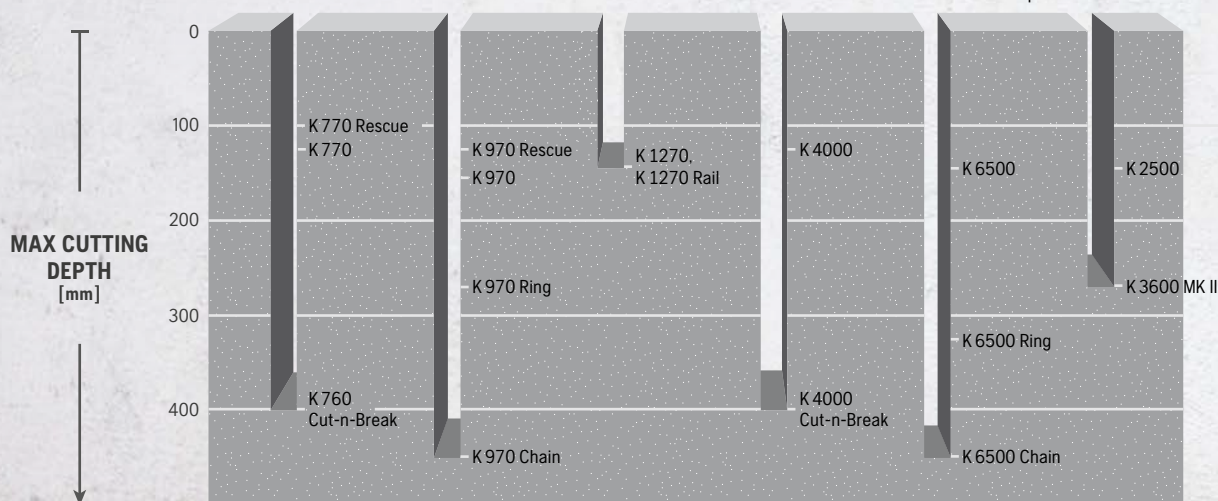



HUSQVARNA PRIME™ PRODUCT RANGE
- LIGHT EQUIPMENT FOR HEAVY JOBS

Our range of high frequency PRIME™ equipment offers outstanding power-to-weight ratio and exceptional usability. You can do wall sawing, drilling and handheld cutting using the same power source. In short, more jobs done with smaller and lighter equipment

HUSQVARNA K 6500 Our most powerful electric handheld cutter ever. The power output, well-balanced body and low vibration levels make it very efficient and easy to use. K 6500 can be powered by PP 65, PP 220 and PP 490.

HUSQVARNA K 6500 RING Our first and most powerful electric ring cutter ever. The 270 mm cutting depth makes this machine a great complement to our wall saws. K 6500 Ring can be powered by PP 65, PP 220 and PP 490.

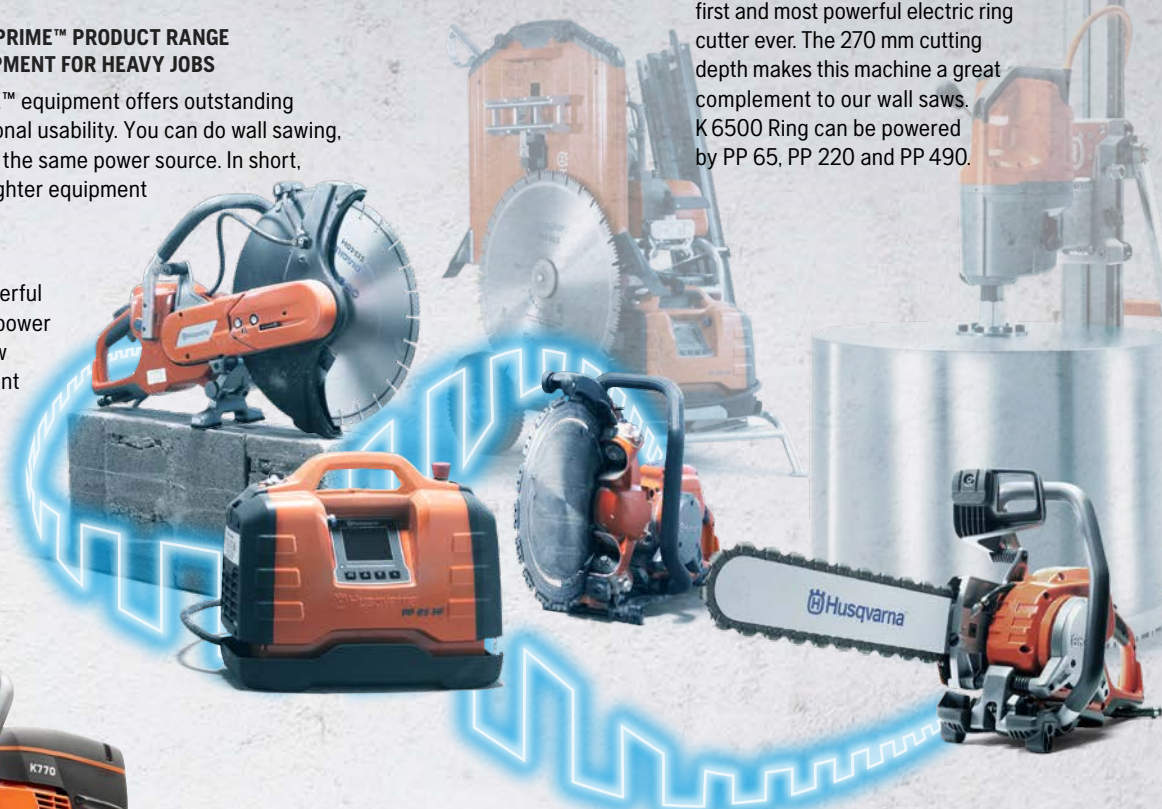

SMARTTENSION™ Husqvarna K770 and K970 are equipped with the semi-automatic, spring-loaded SmartTension™ system which ensures optimal belt tensioning for maximum belt life.

HUSQVARNA K 6500 CHAIN Our first electric chain cutter. Lightweight and powerful. Capable of cutting from 110 × 110 mm wide openings, up to 450 mm deep. Powered by PP 65, PP 220 and PP 490.

THE TRULY GLOBAL POWER CUTTER Husqvarna K770 is our tenth generation of petrol power cutters since it all started in 1960. Designed with nearly 60 years of work experience, K770 is built to deliver unobstructed productivity in any working conditions, anywhere in the world. K770 is undoubtedly the Husqvarna machine that best of all embodies the tradition, heritage, identity and global know-how of our brand.

PROPERTIES BY CUTTING TECHNIQUE

Standard cutting

Deep cutting

RELATIVE CUTTING SPEED

300 MM BLADE	350 MM BLADE	400 MM BLADE	RING	CUT-N-BREAK	CHAIN
High	High	High	Medium	Low	Low

MAX CUTTING DEPTH [mm]

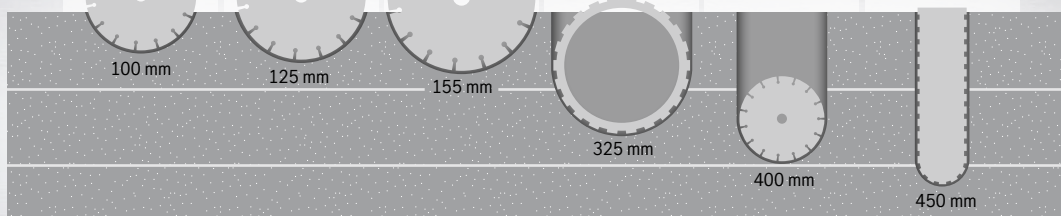

PIPE CUTTING WITH POWER AND EFFICIENCY

Do you need to cut pipe with speed and precision? Look no further than to Husqvarna equipment. With Husqvarna's handheld deep cutting equipment you can cut all the way through the pipe – from one side. This radically reduces the complexity of the job, saving time, effort and money. With Husqvarna's pipe cutting clamp you add even more precision, safety and ergonomics to your bottom line. And all the equipment you need is conveniently available from one single supplier.



HUSQVARNA RING POWER CUTTER WITH PIPE CUTTING CLAMP

- + Cutting depth up to 325 mm
- + Able to cut pipe sections up to outer \varnothing 300 mm in one single cut
- + Higher cutting speed
- + Lower tool cost per cut
- + Unique Husqvarna solution

HUSQVARNA CHAIN POWER CUTTER WITH PIPE CUTTING CLAMP

- + Cutting depth up to 450 mm
- + Able to cut pipe sections up to outer \varnothing 330 mm in one single cut
- + Easy to handle and service
- + Sturdy and flexible
- + Plunge cuts without overcutting

NEW



PRIME



PRIME

HUSQVARNA K 6500 RING Powerful and well-balanced 5.5 kW electric power cutter with high frequency PRIME™ technology, enabling high cutting speed. The 425 mm ring blade produces a cutting depth of 325 mm.

HUSQVARNA K 970 RING Fast-cutting 4.8 kW petrol power cutter with 370 mm ring blade, producing a cutting depth of 270 mm. Sturdy and reliable saw with good cutting capacity and high power-to-weight ratio.

HUSQVARNA K 6500 CHAIN Powerful and well-balanced 5.5 kW electric power cutter with high frequency PRIME™ technology, producing a cutting depth of maximum 450 mm. The same bar also fits the new version of K 970 Chain.

Clamp it on the pipe. Attach a Husqvarna ring or chain power cutter. Cut off pipes up to 14.2"/360 mm outer diameter straight and precise from one position

Husqvarna's pipe cutting clamp is easy to fix securely on the pipe

Flexible design with several fixing points to attach the power cutter. Available for both Ring and Chain power cutters from Husqvarna

Making the whole cut from above means less need for digging around the pipe, which saves you a lot of working time and effort



HUSQVARNA K 970 CHAIN Powerful and reliable 4.8 kW petrol power cutter, producing a cutting depth of maximum 450 mm. New features include the sturdy two-bolt guide bar mount with traditional chain tensioning screw, identical to K 6500 Chain.

PIPE CUTTING CLAMP Enables fast and steady pipe cutting with less strain for the operator. Makes it easy to cut off concrete pipes up to 14"/360 mm diameter from one side straight and precise, using a Husqvarna ring or chain power cutter.

HOW-TO VIDEOS ONLINE Watch instructive videos about pipe cutting and more in our Power Cutter User Guide, available for free in the UpServices section on our website.



PETROL POWER CUTTERS	K 770	K 770 WITH OILGUARD	K 770 VAC	K 970	K 1270
TECHNICAL SPECIFICATIONS					
Air-cooled 2-cycle engine	●	●	●	●	●
Displacement, cc	74	74	74	94	119
Power, kW	3.7	3.7	3.7	4.8	5.8
Power /weight ratio	0.37	0.37	0.30	0.44/0.41	0.43/0.42
Weight, without fuel and cutting equipment, kg	10	10.1	11.3	11.0/11.6	13.3/13.7
Blade/bar, mm	300/350	300/350	300	350/400	350/400
Max cutting depth, mm	100/125	100/125	125	125/155	118/145
Active Air Filtration™	●	●	●	●	●
X-Torq	●	●	●	●	●
SmartCarb™	●	●	●	●	●
DuraStarter™	●	●	●	●	—
EasyStart decompression valve	●	●	●	●	●
Air Purge	●	●	●	●	—
Poly-V belt	●	●	●	●	●
Sealed transmission	●	●	●	●	●
Reversible cutting arm	●	●	●	●	●
Fuel indicator in the tank	●	●	●	●	—
Easy-adjust blade guard	●	●	●	●	●
Wet cutting kit	●	●	—	●	●
Replaceable arbor bushing	●	●	●	●	●
SmartTension™	●	●	—	●	—
Sound power level Lwa, dB (A)	115	115	115	115	117
Sound pressure level, dB (A)	101	101	101	104	104
Vibrations front handle equivalent, m/s ²	2.4/2.4	2.4/2.4	4.0	3.8/3.5	6.9/4.9
Vibrations rear handle equivalent, m/s ²	2.4/2.4	2.4/2.4	2.8	4.2/4.0	6.3/5.3
RECOMMENDED EQUIPMENT					
	KV 7, WT 15	KV 7, WT 15	S26	KV 9/12, WT 15	KV 9/12, WT 15
ARTICLE INFORMATION					
	12", 967 80 86-01, blade guard 300 mm, bore 20 mm*	12" with Oilguard, 967 80 88-01, blade guard 300 mm, bore 20 mm*	967 86 07-01, blade guard 300 mm, bore 20 mm	967 34 80-01, blade guard 350 mm, bore 20/25.4 mm*	967 04 62-01, blade guard 350 mm, bore 20/25.4 mm*
	14", 967 68 21-01, blade guard 350 mm, bore 20/25.4 mm*	14" with Oilguard, 967 69 11-01, blade guard 350 mm, bore 20/25.4 mm*		967 34 81-01, blade guard 400 mm, bore 20/25.4 mm*	967 05 42-01, blade guard 400 mm, bore 20/25.4 mm*
RRP EXC VAT					
	300 MM - £ 815.00	300 MM OILGUARD - £ 850.00	£ 1,299.00	350 MM - £ 1,277.89	350 MM - £ 1,501.19
	350 MM - £ 855.00	350 MM OILGUARD - £ 890.00		400 MM - £ 1,369.24	400 MM - £ 1,501.19

*Includes wet cutting kit as standard.



K 760 CUT-N-BREAK

K 970 RING

K 970 CHAIN

K 970 RESCUE

K 770 RESCUE

K 1270 RAIL

●	●	●	●	●	●
74	94	94	94	74	119
3.7	4.8	4.8	4.8	3.7	5.8
0.33	0.35	0.49	0.44	0.39	0.28/0.27
11.1 (incl. cutting equipment)	13.8	9.6	11.0	9.6	20.5/21.2
230	370	300/350/400	350	300	350/400
400	270	450	125	100	118/145
●	—	—	●	●	●
●	●	●	●	●	—
●	●	●	●	●	●
●	●	●	●	●	—
●	●	●	●	●	●
●	●	●	●	●	—
—	●	—	●	●	●
—	—	—	●	●	●
●	●	●	●	●	—
—	—	—	●	●	●
●	●	●	—	—	—
—	—	—	●	●	●
—	—	—	—	—	—
115	115	115	115	115	117
101	104	104	104	101	104
1.9	2.7	3.6	3.8	2.1	6.1/5.3
2.8	3.4	4.7	4.2	2.3	5.8/5.4

WT 15	Pipe clamp	Pipe clamp			RA 10, RA 10 S
-------	------------	------------	--	--	----------------

967 19 57-01, blade EL 35*	967 27 23-01*	967 66 05-01*	967 63 56-01, blade guard 350 mm, bore 25.4 mm	967 80 91-01, blade guard 300 mm, bore 20.0/25.4 mm	967 04 63-01, incl. RA 10, blade guard 350 mm, bore 25.4 mm
----------------------------	---------------	---------------	--	---	---

967 07 09-01, incl. RA 10LUL, blade guard 350 mm, bore 25.4 mm

967 07 12-01, incl. RA 10, blade guard 400 mm, bore 25.4 mm

£1,649.00	£ 3,749.41	£ 2,510.00	£ 1,454.00	£ 1,085.75	£ 2,422.99
					£ 2,523.99
					£ 2,515.91

**TAKE CARE OF CONCRETE
DUST AND SLURRY IN A SMART
EASY AND EFFICIENT WAY!**

SEE THE SYSTEMS GUIDE ON PAGE 68



NEW



ELECTRIC POWER CUTTERS

K 6500

K 6500 RING

TECHNICAL SPECIFICATIONS

Electric motor, V	230/400	230/400
Power, W	5.5 kW (3-phase)/ 3.0 kW (1-phase)	5.5 kW (3-phase)/ 3.0 kW (1-phase)
Rated current, A	16/10	16/10
Weight excl. cable and cutting equipment, kg	9.8	13.1
Blade, mm	400	425
Cutting depth, mm	155	325
Elgard, overload protection	●	●
"Pulling" rotation	●	●
Simple blade change	●	●
Replaceable arbor bushing	●	—
Wet cutting kit	●	●
Sound power level Lwa, dB (A)	104	111
Sound pressure level, dB (A)	93	99
Vibrations front handle equivalent, m/s ²	< 2.5	< 2.5
Vibrations rear handle equivalent, m/s ²	< 2.5	< 2.5

RECOMMENDED EQUIPMENT

PP 490*, PP 65, PP 220*,
WT 15, W 70 PPP 490*, PP 65, PP 220*,
WA 20, pipe clamp

ARTICLE INFORMATION

967 08 29-01

17"/430 mm, 967 65 99-01

RRP EXC VAT

£ 3,727.08

430 MM – £ 7,064.95

* Read more about PP 220 on pages 80–81.



HYDRAULIC POWER CUTTERS

K 3600 MK II

K 2500

TECHNICAL SPECIFICATIONS

Hydraulic gear motor	●	●
Max. pressure/flow, bar/l/min	150/40	150/40
Power, kW	4.3	5.2
Weight, without cutting equipment, kg	8.3	8.3
Blade, mm	370	400
Cutting depth, mm	270	145
Peripheral drive	●	—
Adjustable front handle	●	—
Automatic start for water flow	●	—
Blade brake	—	●
Servo for rpm control	—	●
Reversible cutting arm	—	●
Wet cutting kit	Integrated	●
Relplaceable arbor bushing	—	●
Sound power level Lwa, dB (A)	111	107
Sound pressure level, dB (A)	99	85
Vibrations front handle equivalent, m/s ²	4.3	7.5
Vibrations rear handle equivalent, m/s ²	6.0	5.2

RECOMMENDED EQUIPMENT

PP 518, PP 325 E, FC 40,
WA 20PP 518, PP 325 E,
FC 40, WA 20

ARTICLE INFORMATION

968 42 41-01

968 36 54-01, blade
guard 400 mm, bore
25.4 mm*

RRP EXC VAT

£ 4,118.97

£ 1,644.91

*Includes wet cutting kit as standard.



NEW



BATTERY POWER CUTTER

K 535i

TECHNICAL SPECIFICATIONS

Battery type	Li-ion
Voltage, V	36
Motor type	BLDC (brushless)
Weight (excl. battery and cutting equipment), kg	3.5
Blade, mm	230
Cutting depth, mm	76
Wet cutting kit	Integrated
savE™	●
Electric retarder	●
Rope eyelet	●
Sound pressure level at operators ear, dB(A)	98.5
Sound power level guaranteed (LWA) dB(A)	109.5
Equivalent vibration level (ahv, eq) front/rear handle, m/s ² *	2.1 / 2.5

RECOMMENDED EQUIPMENT

WT 15, VAC attachment,
dust extractor S 13, S 26

ARTICLE INFORMATION

967 79 59-01

RRP EXC VAT

£ 429.00 **

* with BLI300 ** price does not include battery or charger



K 6500 CHAIN



K 4000



K 4000 CUT-N-BREAK

230/400
5.5 kW (3-phase)/
3.0 kW (1-phase)
16/10
9.1
400
450
●
●
—
—
—
122
99
2.7
2.1

230/120/110
2,700/1,800/2,200
12/15/20
8.5
350
125
●
●
●
●
●
105
95
3.5
3.5

230/120/110
2,700/1,800/2,200
12/15/20
8.9
230
400
●
●
●
—
●
109
95
3.2
3.4

PP 490*, PP 65, PP 220*,
WT 15, pipe clamp

K 3000 / K 4000 Vac attachment,
WT 15, S 13, W 70 P

WT 15

967 10 85-01

967 07 98-01, 230 V, blade guard 350 mm, bore 25.4 mm
967 08 42-01, 110 V, blade guard 350 mm, bore 25.4 mm

967 07 97-01, 230 V, blade EL 10 CNB
967 08 35-01, 110 V, blade EL 10 CNB

£ 4,654.79

110 V - £ 799.00
230 V - £ P0A

110 V - £ 1,554.00
230 V - £ P0A



PP 490



PP 65



PP 325 E



PP 518

POWER UNITS

TECHNICAL SPECIFICATIONS

	PP 490	PP 65	PP 325 E	PP 518
Power output, kW	20	7/4	9.3	10.4
Rated current, A	32/25/16 reduced	16/16 (3-phase/1-phase)	16	—
Voltage, V	400	200-240	400	Petrol-powered
Pressure, bar	—	—	140	140
Flow, l/min	—	—	40	20, 30, 40
Weight incl. oil, kg	25	9.5	95.0	145.0 incl. oil and hoses

RECOMMENDED EQUIPMENT

	PP 490	PP 65	PP 325 E	PP 518
	WS 482 HF, WS 440 HF, CS 10 (together with WS 482 HF or WS 440 HF) K 6500, K 6500 Ring, K 6500 Chain, DM 650	DM 650, K 6500, K 6500 Ring	DM 406 H, K 3600 MK II, K 2500	DM 406 H, K 3600 MK II, K 2500

ARTICLE INFORMATION

	PP 490	PP 65	PP 325 E	PP 518
	967 64 98-01, PP 490, 380-400 V, 5 pin For accessories see page 81	966 56 37-01	965 15 64-04, 400 V, 4 pin SoftStart™	967 15 36-02, incl. hydraulic hose set, 1/2" x 7.6 m

RRP EXC VAT

£ P0A

£ 3,502.00

£ 4,964.18

£ 4,987.26



A Husqvarna KV 9/12 and KV 7.

Husqvarna cutting trolleys with quick connections and easily adjusted cutting depth.

		RRP	EXC VAT
KV 9/ 12, water tank 13.3 litres	587 76 84-02	£ 600.37	
KV 7, water tank 13.3 litres	587 76 84-01	£ 600.37	

B Husqvarna WT 15.

Compact and easy-to-use water tank with electric pump. Battery-powered, 18.5 V Gardena Li-Ion accumulator system. 15 litres

		RRP	EXC VAT
WT 15, 220 V	966 70 83-04	£ 306.90	

C Pressurised water tank.

The tank holds 13.3 litres and comes complete with a 3-metre hose.

		RRP	EXC VAT
Pressurised water tank with hose	506 32 63-02	£ 53.31	
Water hose	506 32 89-34	£ 14.42	

D Vac attachment.

Leading dust collection enables you to cut without water. Quick connection.

		RRP	EXC VAT
K 3000 / K 4000 Vac attachment	523 09 50-01	£ 76.17	

E Husqvarna FC 40.

Flow control allowing use of various hydraulic sources.

		RRP	EXC VAT
FC 40	506 19 75-01	£ 1,460.78	

F Wall cutting attachment.

Supplied complete with carriage, brackets and two 1-metre rails. The cutter fastens easily onto the carriage by way of a swivel screw. Suitable for use with the K 6500 Ring, K 3600 MK II and K 2500.

		RRP	EXC VAT
WA 20, two 1-metre rails and carriage	506 31 93-02	£ 490.02	
Extra rail	506 33 87-03	£ 128.92	
Adapter K 2500	506 32 35-01	£ 100.10	
Adapter K 3600 Ring	506 32 33-01	£ 45.62	
Adapter K 6500 Ring	590 70 88-01	£ 260.09	

G Pipe clamp.

For use with Husqvarna K 970 Ring and Chain and K 6500 Ring and Chain. A convenient accessory for producing straight, precise cuts in concrete pipes.

		RRP	EXC VAT
Pipe clamp	593 35 10-01	£ 1,516.81	
Adaptor for K 6500 Chain	593 36 87-02	£ 170.33	
Adaptor for K 6500 Ring	590 70 88-02	£ 236.05	
Adaptor for K 970 Chain	593 36 87-01	£ 152.40	
Adaptor for K 970 Ring	590 70 88-03	£ 434.25	

APPLICATION OVERVIEW

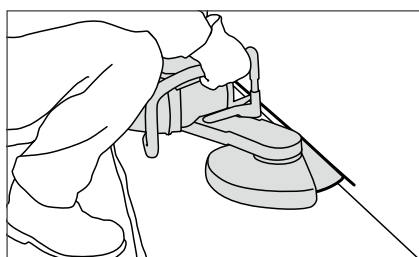

Floor and wall cutting.

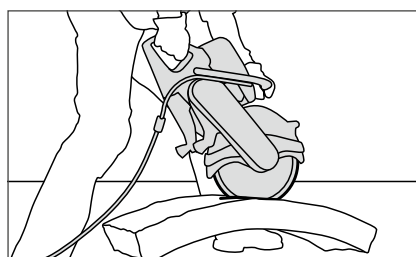

Cutting building blocks, curbstones and garden pavers.

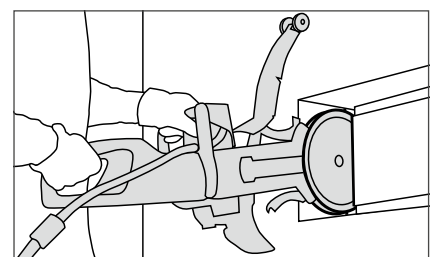

Minor adjustments of window and door openings.

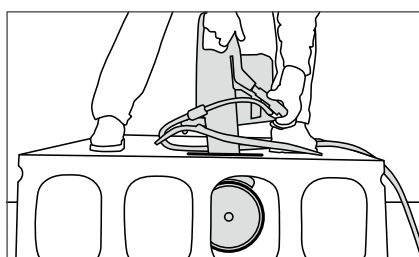

Cutting cast concrete.

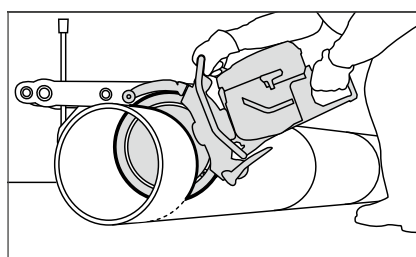

Pipe cutting.

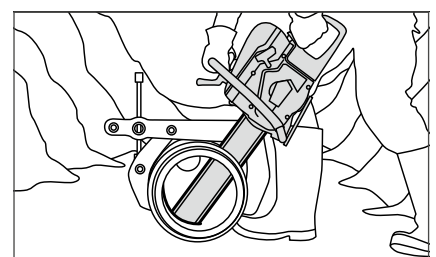

Deep cutting in pipe trenches.



I Wheel kit.

For use with Husqvarna K 760, K 770, K 970 and K 1270. Relieves the operator from strain and protects the underside of the machine when cutting in walls and floors.

	RRP	EXC	VAT
Wheel kit	589 33 43-01		£ 75.49

L Rail cutting attachment.

With zero-play needle and ball bearings. Fits quickly to the rail, up to 135 mm, and provides right-angle cuts on all levels.

	RRP	EXC	VAT
RA 10	506 22 66-11		£ 432.60
RA 10 S	506 22 66-12		£ 515.00

J Cut-n-Break tool.

	RRP	EXC	VAT
Cut-n-Break tool	544 17 80-03		£ 34.49

K Transport boxes.

Made of plywood, with metal reinforcement at edges and corners.

	RRP	EXC	VAT
K 970, K 6500	506 31 08-02		£ 87.92
K 1270	575 46 53-01		£ 92.32
K 970 Ring, K 3600 MK II, K 6500 Ring	575 42 28-01		£ 85.35
K 970 Chain	575 46 51-01		£ 84.04
K 1270 Rail	575 46 53-01		£ 92.32

L Fuel can with non-spill filler.

Made of durable plastic. Approved according to UN regulations. 6 litres.

	RRP	EXC	VAT
Fuel can with non-spill filler	505 69 80-01		£ 22.97

M Two-stroke oil.

Our selection of two-stroke oils is made of the highest quality components. It meets all the high demands that you put on your product.

	RRP	EXC	VAT
Husqvarna Two-stroke oil, HP, 1 litre	587 80 85-10		£ 6.67
Husqvarna Two-stroke oil, HP, 1 litre dosage bottle	587 80 85-11		£ 6.88
Oilguard oil, 1 litre dosage bottle	544 97 65-01		£ 9.59
Oilguard oil, 0.1 litre	544 97 65-02		£ 1.52

N Motor kit.

A complete crankcase with assembled crankshaft, piston and cylinder.

	RRP	EXC	VAT
K 1260	576 22 39-07		£ 316.74
K 970 Engine short block	588 48 71-02		£ 200.19
K 970 Cylinder	586 35 10-02		£ 201.68
K 970 Cylinder*	588 48 71-01		£ 287.34
K 760 Cut-n-Break	585 06 14-04		£ 202.56

*Production from 2014.

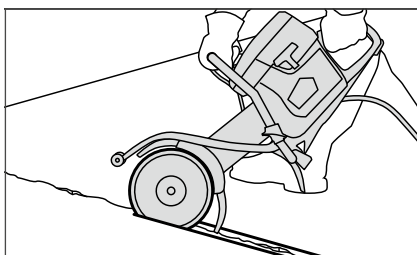

Cutting grooves for expansion joints and crack repair.

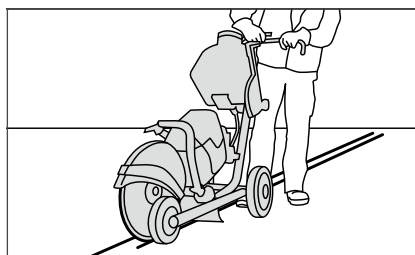

Burying of signal cables.

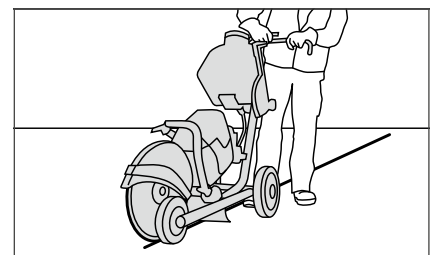

Asphalt cutting in roadworks.

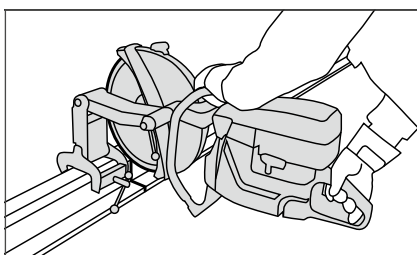

Rail cutting.

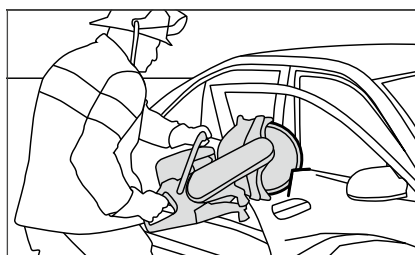

Rescue cutting.

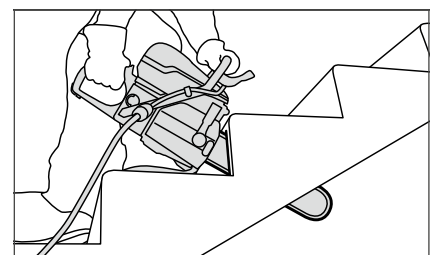

Irregular deep cutting.

DIAMOND TOOLS FOR HANDHELD CUTTING

Husqvarna offers diamond tools for cutting in all types of construction material with all types of handheld equipment, from tools for specialist equipment like ring cutters and chain cutters, to standard diamond blades for more occasional cutting jobs. A diamond blade's properties are determined by the application, the material to be cut and the machine to be used. Therefore, our range of diamond blades are divided in different levels and clearly labelled to make it even easier for you to choose the optimal blade for your type of cutting job.

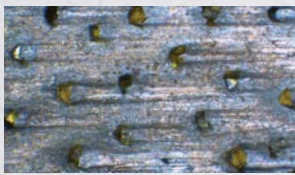

Revolutionary diamond tool technology for great cutting capacity and durability.

With Diagrip™ technology, the diamonds are specially treated to be positioned optimally in the segment, making every diamond work with maximum efficiency. When cutting, the diamonds are exposed and expended at an even rate which makes the edge very even and powerful, especially when working in hard materials like reinforced concrete. This means faster and smoother cutting in all types of construction materials.

SPEED BRIDGE The Elite-Cut blades now feature a specially designed Speed Bridge between the segments. This design further improves cutting speed and smoothness, through reduced lateral friction, better cooling and improved dust evacuation. The colour of the bridge indicates which material the blade is optimised for.

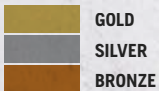

See page 16 for more information.



ELITE-CUT

PRODUCT	S 25	S 35*	S 45	S 50	S 65	S 85
SEGMENT SHAPE						
MATERIAL						
Hard tiles, porcellanato	●	●	—	—	—	—
Ceramic tiles	●●	●●	—	—	—	—
Natural stone	●●●	●●●	—	●	—	—
Cured concrete	●●●	●●●	●●●	●●●	—	—
Reinforced concrete	●●	●●	●●●	●●●	●●●	—
Brick	●●	●●	●●	●●	●●●	—
Roof tile	●●	●●	●●	●●	●●●	—
Abrasive material	—	—	●	●	●●●	●●
Green concrete	—	—	—	—	●●	●●
Asphalt	—	—	—	—	●	●●●
Iron	—	—	—	—	—	—
Ductile iron	—	—	—	—	—	—

K 770, K 970, K 1270, K 6500, K 4000, K 40

●●● = Optimal ●● = Good ● = Acceptable — = Not recommended * Also fits K 770 VAC.



- GOLD
- SILVER
- BRONZE

See page 16 for more information.



DIAGRIP



DIAGRIP

BLADES FOR K 6500 AND HYDRAULIC CUTTERS

PRODUCT	S 1410	S 1420
SEGMENT SHAPE		
MATERIAL		
Stone	● ● ●	—
Concrete, hard	● ● ●	●
Concrete, medium	● ●	● ● ●
Concrete, soft	●	● ● ● ●
Building brick	—	● ● ●
Abrasive building block	—	●
RECOMMENDED EQUIPMENT	K 6500, K 2500	

● ● ● = Optimal ● ● = Good ● = Acceptable — = Not recommended

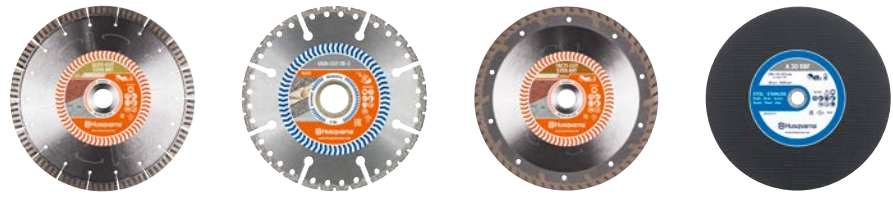

BLADES FOR K 535i, BATTERY POWER CUTTER

PRODUCT	ELITE-CUT S 35 S BAT	VARI-CUT FR3	TACTI-CUT S 35 S BAT	ABRASIVE DISC
SEGMENT SHAPE				
MATERIAL				
Hard tiles, porcellanato	●	●	●	—
Ceramic tiles	●●	●	●●	—
Natural stone	●●●	●	●●●	—
Cured concrete	●●●	●	●●●	—
Reinforced concrete	●●	●	●●	—
Brick	●●	●	●●	—
Roof tile	●●	●	●●	—
Metal	●	●●	●	●●●
Ductile iron	—	●●	—	●●●
RECOMMENDED EQUIPMENT	K 535i			

●●● = Optimal ●● = Good ● = Acceptable — = Not recommended

Husqvarna Elite-Cut power cutter blades.

Gold level blades for easy operation even in heavily reinforced concrete. Innovative segment design for efficient cutting, cooling and slurry evacuation, which increases both cutting speed and service life. S 25 with turbo jointed segments for applications requiring high-quality finishing of cut.

PRODUCT NUMBER	DIAMETER, MM	BLADE GEOMETRY	SEGMENT SHAPE	SEGMENT HEIGHT, MM	BORE, MM	RRP EXC VAT
S 25						
579 81 14-10	300	Jointed segments	Turbo	12	25.4 / 20	£ 111.10
579 81 14-20	350	Jointed segments	Turbo	12	25.4 / 20	£ 181.80
579 81 14-30	400	Jointed segments - silence core	Turbo	12	25.4 / 20	£ 179.73
S 35						
579 81 15-11	300	Segmented	Bridge	15	20	£ 166.60
579 81 15-20	350	Segmented	Bridge	15	25.4 / 20	£ 208.25
579 81 15-30	400	Segmented	Bridge	15	25.4 / 20	£ 255.11
S 45						
579 81 16-11	300	Segmented	Double notch	12	20	£ 166.60
579 81 16-20	350	Segmented	Double notch	12	25.4 / 20	£ 208.25
579 81 16-30	400	Segmented	Double notch	12	25.4 / 20	£ 255.11
579 81 16-40	415	Segmented	Double notch	12	25.4	£ 179.73
S 50						
579 81 18-11	300	Segmented	Bridge	15	20	£ 166.60
579 81 18-20	350	Segmented	Bridge	15	25.4 / 20	£ 208.25
579 81 18-30	400	Segmented	Bridge	15	25.4 / 20	£ 255.11
S 50 P						
582 29 80-01	415	Segmented	Bridge	12	25.4	£ 193.95
S 65						
579 81 19-11	300	Segmented	Double notch	12	20	£ 166.60
579 81 19-20	350	Segmented	Double notch	12	25.4 / 20	£ 208.25
579 81 19-30	400	Segmented	Double notch	12	25.4 / 20	£ 255.11
S 85						
579 81 20-11	300	Segmented	Flat	12	20	£ 166.60
579 81 20-20	350	Segmented	Flat	12	25.4 / 20	£ 208.25
579 81 20-30	400	Segmented	Flat	12	25.4 / 20	£ 255.11

Husqvarna Vari-Cut power cutter blades.

Silver level blades with high cutting speed and wear resistance, providing excellent performance and low tool cost per cut square metre.

PRODUCT NUMBER	DIAMETER, MM	BLADE GEOMETRY	SEGMENT SHAPE	SEGMENT HEIGHT, MM	BORE, MM	RRP EXC VAT
S 35 TURBO						
587 90 57-01	300	Segmented	Turbo	10	25.4/20	£ 124.23
587 90 58-01	350	Segmented	Turbo	10	25.4/20	£ 153.52
587 90 59-01	400	Segmented	Turbo	10	25.4/20	£ 181.80
S 45						
579 81 74-10	300	Segmented	Turbo/Flat	10	25.4/20	£ 124.23
579 81 74-20	350	Segmented	Turbo/Flat	10	25.4/20	£ 153.52
579 81 74-30	400	Segmented	Turbo/Flat	10	25.4/20	£ 181.80
S 50						
586 59 55-11	300	Segmented	Turbo/Flat	10	20.0	£ 124.23
586 59 55-02	350	Segmented	Turbo/Flat	10	25.4/20	£ 153.52
586 59 55-03	400	Segmented	Turbo/Flat	10	25.4/20	£ 181.80
S 65 PLUS						
587 90 44-11	300	Segmented	Turbo/Flat/Flat +	10	20	£ 124.23
587 90 45-01	350	Segmented	Turbo/Flat/Flat +	10	25.4/20	£ 153.52
587 90 53-01	400	Segmented	Turbo/Flat/Flat +	10	25.4/20	£ 181.80
S 85						
579 81 77-11	300	Segmented	Flat/Flat +	10	20	£ 124.23
579 81 77-20	350	Segmented	Flat/Flat +	10	25.4/20	£ 153.52
579 81 77-30	400	Segmented	Flat/Flat +	10	25.4/20	£ 181.80

Husqvarna Tacti-Cut power cutter blades.

Bronze level blades optimised for less intensive professional cutting in most materials, providing a good balance between performance and price.

PRODUCT NUMBER	DIAMETER, MM	BLADE GEOMETRY	SEGMENT SHAPE	SEGMENT HEIGHT, MM	BORE, MM	RRP EXC VAT
S 35						
579 81 57-10	300	Continuous	Turbo	10	25.4/20	£ 46.34
579 81 57-20	350	Continuous	Turbo	10	25.4/20	£ 66.52
S 50 PLUS						
579 81 56-11	300	Segmented	Flat	13	20.0	£ 49.20
579 81 56-20	350	Segmented	Flat	13	25.4/20	£ 80.79
579 81 56-30	400	Segmented	Flat	13	25.4/20	£ 119.00
S 50						
579 81 64-11	300	Segmented	Flat	10	20.0	£ 35.34
579 81 64-20	350	Segmented	Flat	10	25.4/20	£ 45.00
S 65						
579 81 65-11	300	Jointed segments	Turbo/ Flat +	10	20	£ 97.30
579 81 65-20	350	Jointed segments	Turbo/ Flat +	10	25.4/20	£ 126.83
S 85						
579 81 66-10	300	Segmented	Flat +	10	25.4/20	£ 97.30
579 81 66-20	350	Segmented	Flat +	10	25.4/20	£ 126.83

Husqvarna diamond blades for K 6500 and hydraulic cutters.

Gold level blades providing optimal cutting speed in hard and heavily reinforced concrete.
Also available in Pre-Cut versions.

PRODUCT NUMBER	DIAMETER, MM	WATER SLOTS	SEGMENT LENGTH, MM	SEGMENT WIDTH, MM	SEGMENT HEIGHT, MM	BORE, MM	RRP EXC VAT
S 1410 DIAGRIP™							
583 80 06-01	415	Narrow	40	3.0	10+2	25.4	£ 281.40
S 1420 DIAGRIP™							
589 29 75-01	415	Narrow	40	3.0	10+2	25.4	£ 281.40
S 1410 PRE-CUT DIAGRIP™							
583 80 06-02	415	Narrow	40	4.2	10+2	25.4	£ 297.47
583 80 06-03	415	Narrow	40	6.0	10+2	25.4	£ 322.73
S 1420 PRE-CUT DIAGRIP™							
589 29 75-02	415	Narrow	40	4.2	10+2	25.4	£ 280.65

Husqvarna Elite-Cut battery-powered power cutter blades.

Gold level blade with high cutting speed, wear resistance, low vibration and silence core, optimal for intensive professional use

PRODUCT NUMBER	DIAMETER, MM	BLADE GEOMETRY	SEGMENT HEIGHT, MM	BORE, MM	FEATURE	RRP EXC VAT
S 35 S BAT 230 12 22.2						
596 82 66-01	230	Jointed Segments	Turbo	22.2	Silence	£ 89.89

Husqvarna Vari-Cut FR3 battery-powered power cutter blades.

Rescue blade with vacuum-brazed diamond edge specially designed for cutting through all construction and vehicle materials at the highest speed.

PRODUCT NUMBER	DIAMETER, MM	BLADE GEOMETRY	SEGMENT HEIGHT, MM	BORE, MM	FEATURE	RRP EXC VAT
VARI-CUT FR3						
574 85 38-01	230			22.2	Multi Purpose	£ 88.94

Husqvarna Tacti-Cut battery-powered power cutter blades.

Bronze level blade offers optimal balance between cutting speed, wear resistance and price for the occasional user. Low vibration and silent core.

PRODUCT NUMBER	DIAMETER, MM	BLADE GEOMETRY	SEGMENT HEIGHT, MM	BORE, MM	FEATURE	RRP EXC VAT
S 35 S BAT 230 10 22.2						
596 52 03-01	230	Continuous	Turbo	22.2	Silence	£ 59.59

Husqvarna abrasive discs.

Top-grade abrasive discs, developed specifically for use with handheld power cutters. Can cut practically any material. A good choice for use on steel and other metals.

PRODUCT NUMBER	DIAMETER, MM	BORE, MM	MATERIAL	RRP EXC VAT
504 00 08-03	350	25.4	Railway rail	£ 11.96
504 00 10-03	400	25.4	Railway rail	£ 21.55



DIAMOND TOOLS FOR SPECIAL APPLICATIONS

Husqvarna has a long tradition of developing diamond tools for special cutting applications that require operators with special skills. Our innovations in the area of handheld cutting include our ring saws, chainsaw and Cut-n-Break tool, with cutting depths up to 400 mm. R1400 series of ring saw blades has the Diagrip™ technology giving this ring blade a very high cutting speed, long life and a smooth cut.



See page 16 for more information.

PRODUCT	ELITE-RING			VARI-RING			RING BLADE		BLADES FOR CUT-N-BREAK		
	R 10	R 20	R 45	R 20	R 45	R 70	PRE-CUT	FR3	EL 10 CNB	EL 35 CNB	EL 70 CNB
SEGMENT SHAPE											
MATERIAL											
Stone	●●●	●●	●	●●	●	—	●●	●	●●●	●	—
Concrete, hard	●●●	●●	●●	●●●	●●	—	●●	●	●●●	●●	—
Concrete, medium	●●●	●●●	●●●	●●●	●●●	—	●●●	●	●	●●●	—
Concrete, soft	●●	●●	●●●	●●	●●●	●	●●	●	—	●●●	●
Building brick	●	●	●	●	●	●●●	●●	●	—	●	●●●
Abrasive building block	—	—	—	—	—	●●●	●●	●	—	—	●●●
Iron	—	—	—	—	—	—	—	●●●	—	—	—
Ductile iron	—	—	—	—	—	—	—	●●●	—	—	—
RECOMMENDED EQUIPMENT	K 970 Ring, K 6500 Ring, K 3600 MK II									K 4000 Cut-n-Break	



DIAMOND CHAINS

PRODUCT	PRO 45		PXC 45		ELC 45		ELC 70		SLC 45	
	PRO 45		PXC 45		ELC 45		ELC 70		SLC 45	
SEGMENT SHAPE										
MATERIAL										
Stone	●●	●●	●●	●●	●●	●●	—	—	●	●
Concrete, hard	●●●	●●●	●●●	●●●	●●●	●●●	—	—	●●●	●●●
Concrete, medium	●●●	●●●	●●●	●●●	●●●	●●●	●	●	●●●	●●●
Concrete, soft	●●●	●●●	●●●	●●●	●●●	●●●	●●	●●	●●	●●
Building brick	●●	●●	●●	●●	●	●	●●●	●●●	●	●
Abrasive building block	●	—	—	—	—	—	●●●	●●●	●	●

K 6500 Chain, K 970 Chain

●●● = Optimal ●● = Good ● = Acceptable — = Not recommended

Husqvarna diamond blades for ring cutters.

A range of gold and silver level blades with self sharpen segments, designed to give a free-cutting tool regardless of direction of blade rotation.

PRODUCT NUMBER	DIAMETER, MM	SEGMENT LENGTH, MM	SEGMENT WIDTH, MM	SEGMENT HEIGHT, MM	RRP EXC VAT
ELITE-RING R 10					
583 80 23-01	370	33	4.2	9	£ 323.20
593 72 77-01	430	33	4.2	13	£ 420.16
ELITE-RING R 20					
587 02 42-01	370	33	4.2	9	£ 323.20
593 72 79-01	430	33	4.2	13	£ 420.16
ELITE-RING R 45					
587 02 43-01	370	33	4.2	9	£ 323.20
VARI-RING R 20					
574 83 63-01	370	33	4.2	9	£ 188.72
596 80 79-01	430	33	4.2	13	£ 349.00
VARI-RING R 45					
574 83 63-02	370	33	4.2	9	£ 188.72
VARI-RING R 70					
574 83 63-03	370	33	4.2	9	£ 188.72
PRE-CUT RING BLADE					
583 80 23-02	370	33	6.0	9	£ 354.27
593 72 77-02	430	33	6.0	13	£ 460.56
VARI RING FR 3					
574 47 87-02	370	33	4.2	9	£ 332.59
593 72 76-01	430	33	4.2	13	£ 420.16

Husqvarna diamond blades for Cut-n-Break cutters.

Gold level blades that cut in stages through walls up to 400 mm thick, with a very low diamond tool investment.

PRODUCT NUMBER	SEGMENT LENGTH, MM	SEGMENT WIDTH, MM	SEGMENT HEIGHT, MM	NUMBER OF DISCS	RRP EXC VAT
EL 10 CNB					
574 83 62-01	40	2.4	8.5	2	£ 352.49
EL 35 CNB					
574 83 62-02	40	2.4	8.5	2	£ 352.49
EL 70 CNB					
574 83 62-03	40	2.4	8.5	2	£ 352.49

Husqvarna diamond chains and guide bars for chain cutters.

A range of professional, premium and quality chains for sawing in reinforced concrete and other construction materials in different hardness.

PRODUCT NUMBER	CHAIN PITCH, INCH	CHAIN/BAR LENGTH, MM / INCH	NUMBER OF SEGMENTS	SEGMENT WIDTH, MM	RRP EXC VAT
PRO 45					
588 15 04-01	0.444	300/12	25	5.7	£ 1 005.05
588 15 04-02	0.444	400/16	29	5.7	£ 1 146.46
PXC 45					
590 32 98-01	3/8	350/14	32	5.7	£ 724.98
ELC 45					
590 32 99-01	3/8	350/14	32	5.7	£ 582.97
ELC 70					
590 33 00-01	3/8	350/14	32	5.7	£ 582.97
SLC 45					
590 33 01-01	3/8	350/14	32	5.7	£ 459.65

GUIDE BARS	RRP EXC VAT
300 mm/12" (0.444")	587 78 14-01 £ 80.52
350 mm/14" (3/8")	506 34 62-14 £ 148.73
400 mm/16" (0.444")	587 78 14-02 £ 114.83

CHAIN ACCESSORIES	RRP EXC VAT
Repair kit for chain segments (0.444")	588 10 68-11 £ POA
Repair kit for chain links (0.444")	588 10 68-12 £ POA
Repair kit for chain segments (3/8")	531 10 11-94 £ 44.74
Repair kit for chain links (3/8")	531 10 11-95 £ 14.86



VACUUM-BRAZED RESCUE BLADE

Special rescue cutting blade with vacuum-brazed diamond edge, capable of cutting through all construction and vehicle materials at the highest cutting speed.



Husqvarna Rescue blades.

A layer of vacuum brazed diamonds give the blade an outstanding cutting performance, and is suitable for cutting most materials likely to be encountered in an emergency situation.

PRODUCT NUMBER	DIAMETER, MM	BORE, MM	BLADE GEOMETRY	RRP EXC VAT
VARI-CUT FR3				
574 85 39-01	300	25.4/20.0	Segmented	£ 167.66
574 85 40-01	350	25.4/20.0	Segmented	£ 197.96
574 85 41-01	400	25.4/20.0	Segmented	£ 248.46

RESCUE BLADES

PRODUCT	VARI-CUT FR3
SEGMENT SHAPE	
MATERIAL	
Cured concrete	●
Reinforced concrete	●
Brick	●
Roof tile	●
Abrasive material	●
Green concrete	●
Asphalt	●
Iron	●●●
Ductile iron	●●●
RECOMMENDED EQUIPMENT	K 970 Rescue, K 770 Rescue

DIAMOND TOOLS FOR ANGLE GRINDERS

Our diamond tools for angle grinders have been developed on the basis of our long experience, which is characterized by continual innovation and improvement. Elite-Cut blades provide maximum cutting speed and life, while Vari-Cut blades are developed specifically for the professional user who wants value for money as well as good performance. Tacti-Cut blades are good complements to the professional blades, giving high cutting speed and a good balance between investment and performance. Husqvarna Rescue blades are developed for cutting a wide variety of materials, without having to change between different blades. For use by trained operators only. The Husqvarna grinding cup wheels are supplied in all required grit sizes for a wide application range.



SPEED BRIDGE The Elite-Cut blades now feature a specially designed Speed Bridge between the segments. This design improves the cutting speed and smoothness even further through reduced lateral friction, better cooling and improved dust evacuation. The colour of the bridge indicates which material the blade is optimised for.

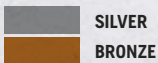

See page 16 for more information.



VARI-CUT

TACTI-CUT

PRODUCT	SILVER		BRONZE			
	S90	FR3	S4	S35 TURBO	S50	S65
SEGMENT SHAPE						
MATERIAL						
Hard tiles, porcellanato	—	—	●●	—	—	—
Ceramic tiles	—	—	●●●	●●	—	—
Natural stone	—	—	●●	●●	●	—
Concrete	—	●	●	●●	●●●	●●
Brick	—	●	●	●●	●●	●●●
Abrasive material	—	●	—	●	●●	●●●
Mortar raking	●●●	—	—	—	—	—
Iron	—	●●●	—	—	—	—
Ductile iron	—	●●●	—	—	—	—

●●● = Optimal ●● = Good ● = Acceptable — = Not recommended



VARI-GRIND

TACTI-GRIND

PRODUCT	G 35	G 45	G 50	G 65	G 45	G 50	G 65
MATERIAL							
Natural stone	●	●	●●	●	●	●●	●
Concrete soft	●●●	●●●	●●●	●●●	●●●	●●●	●●●
Concrete medium	●●●●	●●●●	●●●●	●●●●	●●●●	●●●●	●●●●
Concrete hard	●●●●	●●●●	●●	●●	●●●●	●●	●●
Bricks	●	●	●●	●●	●	●●	●●

●●●● = Optimal ●●● = Good ●● = Acceptable ● = Not recommended

Husqvarna Vari-Cut angle grinder blades.

Silver level blades with high cutting speed and wear resistance in all materials.

PRODUCT NUMBER	DIAMETER, MM	BLADE GEOMETRY	SEGMENT SHAPE	SEGMENT HEIGHT, MM	BORE, MM	RRP EXC VAT	RRP EXC VAT
S 90							
579 80 81-40	125	Segmented	Flat	10	22.2		£ 47.02
FR3 RESCUE							
577 10 36-01	115	Segmented	—	—	22.2		£ 48.58
574 85 37-01	125	Segmented	—	—	22.2		£ 52.69
574 85 38-01	230	Segmented	—	—	22.2		£ 88.94

Husqvarna Tacti-Cut angle grinder blades.

Bronze level blades optimised for less intensive professional cutting in most materials.

PRODUCT NUMBER	DIAMETER, MM	BLADE GEOMETRY	SEGMENT SHAPE	SEGMENT HEIGHT, MM	BORE, MM	RRP EXC VAT	RRP EXC VAT
S 4							
579 81 96-30	115	Continuous	Flat	10	22.2		£ 10.46
579 81 96-40	125	Continuous	Flat	10	22.2		£ 13.45
579 81 96-80	230	Continuous	Flat	10	22.2		£ 39.24
S 35							
579 82 04-30	115	Continuous	Turbo	10	22.2		£ 12.33
579 82 04-40	125	Continuous	Turbo	10	22.2		£ 15.30
579 82 04-80	230	Continuous	Turbo	10	22.2		£ 39.24
S 50							
579 81 92-30	115	Segmented	Flat	10	22.2		£ 8.97
579 81 92-40	125	Segmented	Flat	10	22.2		£ 9.34
579 81 92-60	180	Segmented	Flat	10	22.2		£ 17.00
579 81 92-80	230	Segmented	Flat	10	22.2		£ 24.66
S 65							
579 82 05-30	115	Jointed segments	Turbo/Flat +	9	22.2		£ 19.25
579 82 05-40	125	Jointed segments	Turbo/Flat +	9	22.2		£ 19.65
579 82 05-80	230	Jointed segments	Turbo/Flat +	9	22.2		£ 52.32

Husqvarna Vari-Grind cup wheels.

Silver level cup wheels for professional use, providing efficient grinding in all materials.

PRODUCT NUMBER	DIAMETER, MM	SEGMENT HEIGHT, MM	CONNECTOR	CUP GEOMETRY	RRP EXC VAT	RRP EXC VAT
G 35						
579 82 11-01	100	5	22.2/M14	Fan		£ 68.39
579 82 11-30	115	5	22.2/M14	Fan		£ 56.80
579 82 11-40	125	5	22.2/M14	Fan		£ 65.77
579 82 11-50	150	5	19.0	Fan		£ 82.96
579 82 11-60	180	5	22.2	Fan		£ 126.68
G 45						
579 82 13-30	115	5	22.2/M14	Single row		£ 59.42
579 82 13-40	125	5	22.2/M14	Single row		£ 66.89
579 82 13-60	180	5	22.2	Single row		£ 89.31
G 50						
579 82 14-30	115	5	22.2/M14	Turbo		£ 56.80
579 82 14-40	125	5	22.2/M14	Turbo		£ 65.77
579 82 14-60	180	5	22.2	Turbo		£ 126.68
G 65						
579 82 15-30	115	5	22.2/M14	Double row		£ 56.80
579 82 15-40	125	5	22.2/M14	Double row		£ 65.77
579 82 15-60	180	5	22.2	Double row		£ 126.68



Husqvarna Tacti-Grind cup wheels.

Bronze level cup wheels developed for less intensive use, offering good price performance.

PRODUCT NUMBER	DIAMETER, MM	SEGMENT HEIGHT, MM	CONNECTOR	CUP GEOMETRY	RRP EXC VAT
G 45					
582 23 89-30	115	5	22.2	Single row	£ 37.00
582 23 89-40	125	5	22.2	Single row	£ 42.60
582 23 89-60	180	5	22.2	Single row	£ 82.21
G 50					
582 24 22-30	115	5	22.2	Turbo	£ 52.32
582 24 22-40	125	5	22.2	Turbo	£ 59.04
582 24 22-60	180	5	22.2	Turbo	£ 78.85
G 65					
582 24 23-30	115	5	22.2	Double row	£ 55.68
582 24 23-40	125	5	22.2	Double row	£ 65.77
582 24 23-60	180	5	22.2	Double row	£ 80.15

BUILT TO PERFORM. READY TO DELIVER.

Husqvarna's range of battery-powered products are always adapted for the job at hand. The motor and battery has been optimised for each machine in order to provide the very best combination of comfort, balance and performance. And since every charge costs a fraction of refuelling a petrol tank, you will repay your investment in Husqvarna battery equipment sooner than you think.

The batteries and motors all developed and tested by Husqvarna, delivering durability and performance in any kind of weather or conditions. All vital parts are encapsulated, making the machines rain and dust resistant to keep you going until the work is done.

A NEW WAY TO THE PERFECT CUT

Husqvarna battery-powered power cutter is as convenient as it gets, providing power for the quick and easy cuts wherever it's needed – without cords or dependence on access to the grid. The perfect choice for land- and hardscapers alike, the battery-powered power cutter will provide you with an excellent addition to your operation.

ROPE EYELET

A foldable rope eyelet integrated in ground support, for maximised convenience.

BATTERY BLADES

For fast cutting speed, minimised disturbance and wear, indicators have been customized for K 535i. The power cutter can also be fitted with abrasive discs up to 3 mm.

SMART BATTERY PLACEMENT

The side-fed placement of the battery maximises cooling and minimize slurry and dust containment.



PERFECT BALANCE

The centered placement of the blade provides increased stability and control, compared to conventional angle grinders.

ELECTRIC BLADE BREAK

For increased safety and ease of use, the blade will stop its rotation – from full throttle to zero in 3.1 seconds.

ERGONOMIC HANDLES

The handles are specially developed to be comfortable and increases control for extra safety while cutting.

INTUITIVE KEYPAD

For perfect control, the intuitive keypad is designed for quick commands and features a saveE™ function.

WET AND DRY CUTTING

The K 535i can be used for both wet and dry cutting. Adding wet cutting accessories like the WT 15 is easy and quickly done.



PREPARED FOR CONNECTIVITY

By adding a Bluetooth battery, the power cutter can connect and transmit status data to, for example, Husqvarna Fleet Services™.

LIGHTWEIGHT MANOEUVRABILITY

The slim design and low weight of only 3.5 kg makes the K 535i easy to lift, control and manoeuvre during operation.

BATTERY*	CUT OFF QUANTITY			
	CONCRETE GARDEN PLATES, 40 MM	ROOF TILES	GRANITE, 70 MM	FLOOR TILES, 7 MM
BLi200	20 pcs	85 pcs	6 pcs	140 pcs
BLi300	40 pcs	165 pcs	10 pcs	240 pcs

*Given guidelines are indicative only and may not always be repeatable from one setting to another.

NEW



BATTERY POWER CUTTER **K 535i**

TECHNICAL SPECIFICATIONS

Battery type	Li-ion
Voltage, V	36
Motor type	BLDC (brushless)
Weight (excl. battery and cutting equipment), kg	3.5
Blade, mm	230
Cutting depth, mm	76
Wet cutting kit	Integrated
savE™	●
Electric retarder	●
Rope eyelet	●
Sound pressure level at operators ear, dB(A)	98.5
Sound power level guaranteed (LWA) dB(A)	109.5
Equivalent vibration level (ahv, eq) front/rear handle, m/s ² *	2.1 / 2.5

RECOMMENDED EQUIPMENT

WT 15, VAC attachment, dust extractor S 13, S 26

ARTICLE INFORMATION

967 79 59-01**

RRP EXC VAT

£ 429.00

* with BLi300 ** battery and chargers are not included in RRP



BATTERY CHAINSAWS **T 535i XP®** **535i XP®**

TECHNICAL SPECIFICATIONS

Battery type	Li-Ion	Li-Ion
Voltage, V	36	36
Motor type	BLDC (brushless)	BLDC (brushless)
Weight (excl. battery and cutting equipment), kg	2.4	2.6
Chain speed max power, m/s	20	20
Chain pitch, inch	3/8"	1/4", 3/8"
Recommended bar length, min-max, cm	25-35	25-35
Sound pressure level at operators ear, dB(A)	93	93
Sound power level guaranteed (LWA) dB(A)	106	106
Equivalent vibration level (ahv, eq) front/rear handle, m/s ² *	2.0 / 2.4	2.5 / 2.8

ARTICLE INFORMATION

967 89 39-12**/** 967 89 38-14**/**

RRP EXC VAT

£ 350.00

£ 300.00

* with BLi300 ** battery and chargers are not included in RRP

*** product can only be purchased for resale subject to agreement and compliance to specific legal terms and criterias.



BATTERY BLOWERS **550iBTX** **530iBX** **525iB** **320iB MARK II**

TECHNICAL SPECIFICATIONS

Battery type	Li-ion	Li-ion	Li-ion	Li-ion
Voltage, V	36	36	36	36
Motor type	BLDC (brushless)	BLDC (brushless)	BLDC (brushless)	BLDC (brushless)
Weight (excl. battery), kg	6.3	2.9	2.4	2.4
Air speed boost, m/s	67	56.2	56	54
Air flow in pipe, m ³ /min	12.7	12.4	11.6	10.8
Sound power level Lwa, dB (A)	N/A	91	98	96
Sound pressure level, dB (A)	76.6	77.6	82	81
Equivalent vibration level (ahv, eq) handle, m/s ² *	N/A	0.4	0.5	0.7

ARTICLE INFORMATION

967 68 11-02**/** 967 94 14-02**/** 967 91 55-02**/** 967 91 54-02**/**

RRP EXC VAT

£ 458.33

£ 350.00

£ 316.67

£ 241.67

* with BLi300 ** battery and chargers are not included in RRP

*** product can only be purchased for resale subject to agreement and compliance to specific legal terms and criterias.

The products shown here are only a selection. For the full range offer please visit www.husqvarnacp.co.uk



BATTERY FORESTRY CLEARING SAW / POLE SAWS

	530iPT5	530iP4
TECHNICAL SPECIFICATIONS		
Battery type	Li-Ion	Li-Ion
Voltage, V	36	36
Motor type	BLDC (brushless)	BLDC (brushless)
Weight (excl. cutting equipment), kg	5.0	3.4
Chain speed max power m/s	20	20
Chain pitch, inch	3/8 / 1/4	3/8 / 1/4
Recommended bar length, min-max, cm	25-30	25-30
Length, extended, with cutting equipment, cm	400	250
Sound pressure level at operators ear, dB(A)	83	88
Sound power level guaranteed (LWA) dB(A)	98	98
Equivalent vibration level (ahv, eq) front /rear handle, m/s ² *	1.0 / 1.2	1.0 / 0.9
ARTICLE INFORMATION		
	967 88 48-10**/***	967 88 47-10**/***
RRP EXC VAT	£ 404.17	£ 341.67

* with BLI300 ** battery and chargers are not included in RRP
 *** products can only be purchased for resale subject to agreement and compliance to specific legal terms and criterias.



	520iHE3	520iHD70	520iHD60
TECHNICAL SPECIFICATIONS			
Battery type	Li-Ion	Li-Ion	Li-Ion
Voltage, V	36	36	36
Motor type	BLDC (brushless)	PMDC (4-brush)	PMDC (4-brush)
Weight (excl. battery), kg	4.15	3.9	3.8
Length cutting deck, cm	55	70	60
Length, extended, with cutting equipment, cm	226	127	117
Teeth opening, mm	32	32	32
Cutting speed cuts /min	4,000	4,000	4,000
Sound power level guaranteed (LWA), dB(A)	84	94	94
Equivalent vibration level (ahv, eq) front /rear handle, m/s ² *	3.5/2.5	2.3/3.5	1.6/2.5
ARTICLE INFORMATION			
	967 91 58-11**/***	967 91 57-02**/***	967 91 56-02**/***
RRP EXC VAT	£ 270.83	£ 291.67	£ 266.67

* with BLI300 ** battery and chargers are not included in RRP
 *** products can only be purchased for resale subject to agreement and compliance to specific legal terms and criterias.



	520iRX	520iLX
BATTERY BRUSHCUTTER / TRIMMER		
TECHNICAL SPECIFICATIONS		
Battery type	Li-Ion	Li-Ion
Voltage, V	36	36
Motor type	BLDC (brushless)	BLDC (brushless)
Weight (excl. battery), kg	3.8	3.0
Tube diameter, mm	24	24
Cutting diameter, cm	40	40
Sound pressure level at operators ear, dB(A)	76.1	76.1
Sound power level guaranteed (LWA) dB(A)	96	96
Equivalent vibration level (ahv, eq) left /right handle, m/s ² *	1.2 / 0.7	—
Equivalent vibration level (ahv, eq) front /rear handle, m/s ² *	—	1.2 / 0.7
ARTICLE INFORMATION		
	967 91 62-02**/***	967 91 61-11**/***
RRP EXC VAT	£ 270.83	£ 258.33

* with BLI300 ** battery and chargers are not included in RRP *** products can only be purchased for resale subject to agreement and compliance to specific legal terms and criterias.

QUICK CHARGING. LONG-LASTING PERFORMANCE.

The Husqvarna BLi battery system is the most flexible available on the market today, with performance second to none. Just charge up, plug in and switch on for peak performance with no loss of power: they're always good to go.

Naturally, Husqvarna chargers are constructed to keep you and your battery-powered equipment up and running. Our range of chargers and smart charging algorithm quickly charges the battery up to 80% – in as little as half an hour – before it continues with the last 20%.



BATTERIES	BLi950X	BLi550X	BLi300	BLi200
TECHNICAL SPECIFICATIONS				
Battery type	Li-ion	Li-ion	Li-ion	Li-ion
Battery voltage, V	36	36	36	36
Capacity, Ah	31.1	15.6	9.4	5.2
Energy, Wh	1,120	562	338	187
Weight, integrated, kg	—	—	1.9	1.3
Weight, backpack excl. harness, kg	7	5.5	—	—
Weight, backpack incl. harness, kg	8.5	7.1	—	—
State of charge indication	4-LED	4-LED	4-LED	4-LED
Charging cycles (up to)	1,500	1,500	1,500	1,500
ARTICLE INFORMATION				
	967 96 46-01	967 96 45-01	967 96 43-01	967 96 41-01
RRP EXC VAT	£ 1,150.00	£ 750.00	£ 280.00	£ 210.00



CHARGERS	QC500	QC330	QC80F	VI600F, VOLTAGE INVERTER
TECHNICAL SPECIFICATIONS				
Weight, kg	1.4	1.4	0.6	—
Charging power, W	500	330	80	—
Mains voltage, V	100-240	100-240	12	—
ARTICLE INFORMATION				
	967 96 50-01	967 96 49-01	967 96 48-01	967 96 51-01
RRP EXC VAT	£ 135.00	£ 95.00	£ 50.00	£ 190.00

Husqvarna battery.

ACCESSORIES

1	Battery Bag	585 37 18-01
2	Systainer, small	585 42 87-01
2	Systainer, large	585 42 88-01
3	BLICARRIER	590 77 72-01



HOW LONG WILL THE BATTERY LAST?

The working time available with a fully charged battery depends on three variables: the capacity of the battery, which machine the battery is used with and if you're doing light or tough cutting/trimming. The chart shows an estimate of the operating time you can expect from your Husqvarna battery equipment in different work situations.

The charging time for a fully discharged battery depends on the capacity of the battery and which of the chargers you use. In many cases the charging time will be shorter than the working time. This means with two batteries available, you can work continuously – one battery operating and the other battery charging.



CHARGING TIME FOR DIFFERENT BATTERIES AND CHARGERS

BATTERY	CHARGING CYCLES	QC500 CHARGING LEVEL		QC330 CHARGING LEVEL		QC80F CHARGING LEVEL	
		80%	100%	80%	100%	80%	100%
BLi950X	1,500	1 h 40 min	2 h 55 min	3 h	4 h 5 min	–	–
BLi550X	1,500	1 h	1 h 25 min	1 h 40 min	2 h 5 min	–	–
BLi300	1,500	35 min	1 h	55 min	1 h 20 min	4 h	4 h 20 min
BLi200	1,500	30 min	50 min	30 min	50 min	2 h 25 min	2 h 40 min

WORKING TIME ON ONE CHARGE

BATTERY	535i XP®			T535i XP®	120i	530iPX	530iPT5 / 530iP4	520iRX / 520iLX		520iHE3/520iHD70 / 520iHD60		550iBTX*		530iBX** / 525iB / 320iB MARK II	
	CARPENTER	PRUNING	LOG CUT	PRUNING		CLEARING	PRUNING	LIGHT	TOUGH	LIGHT	TOUGH	LIGHT	TOUGH	LIGHT	TOUGH
BLi950X	18 h 40 min	7 h 30 min	3 h 20 min	13 h	3 h	8 h 15 min	11 h 30 min	8 h 15 min	4 h 15 min	12 h 30 min	6 h	1 h 45 min	1 h	3 h 30 min	1 h 45 min
BLi550X	9 h 20 min	3 h 45 min	1 h 45 min	6 h 30 min	1 h 30 min	4 h 15 min	5 h 45 min	4 h 15 min	2 h	6 h 15 min	3 h	50 min	30 min	1 h 45 min	45 min
BLi300	5 h 30 min	2 h 15 min	1 h	4 h	–	2 h 30 min	3 h 30 min	2 h 30 min	1 h 15 min	3 h 45 min	1 h 45 min	–	–	1 h	35 min
BLi200	3 h	1 h 15 min	35 min	2 h 15 min	45 min	1 h 20 min	2 h	1 h 20 min	40 min	2 h	1 h	–	–	35 min	15 min

The runtimes are up-to-times and correspond to work time using save™. actual work, basic maintenance and movement /climbing needed for generic operations.

*Requires BLi backpack batteries. **Requires backpack battery / battery belt FLEXI.

Best option

STURDY, RELIABLE SAWS FOR TILE AND MASONRY, BUILT TO TACKLE YOUR WORKDAY CHALLENGES

Husqvarna table saws are efficient, highly portable and easy to use whether you're cutting large bricks or small tiles. For us it's vital that there's a perfect match between the material, the machine and the diamond tool. So you can always cut with maximum precision.

ROBUST The robust single-piece frame with integrated conveyor rails gives great rigidity and provides longer product life.



EASY TO TRANSPORT The foldable legs make it easy to set up and transport.

Range overview.

The range of Husqvarna table saws consists of 5 models optimised for different applications.

MASONRY SAWS Husqvarna masonry saws are developed for efficient and precise cutting of all kinds of bricks and building blocks. Their sturdy, rigid design make them stable enough to cut large, heavy blocks. Transport, set up and handling is easily done by one person.



TS 400 F



TS 350 E

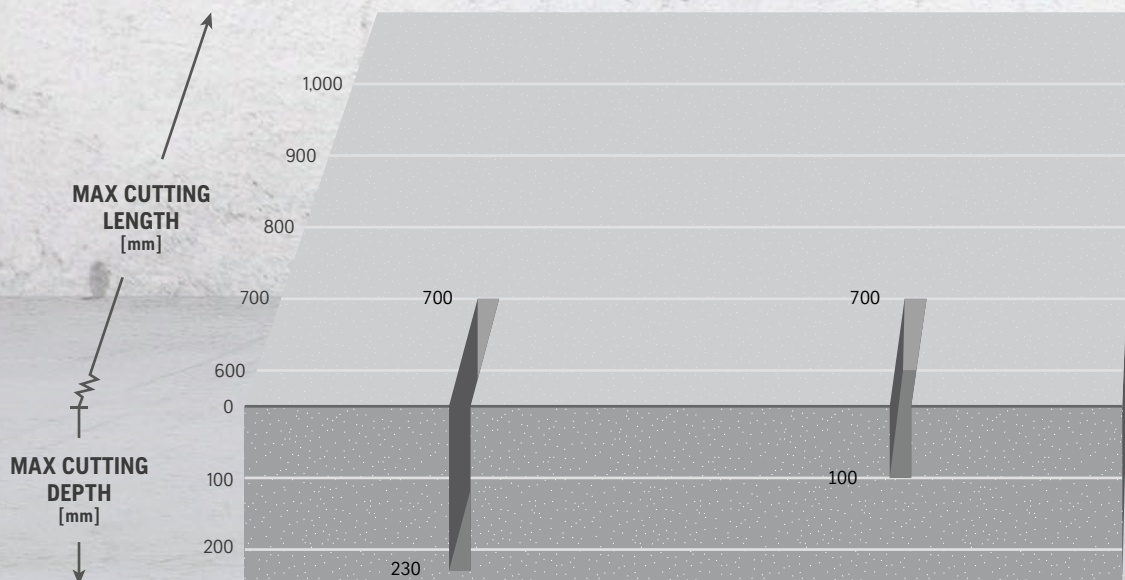



VERSATILE With the TS 73 R you can do plunge and bevel cuts at 45 or 90 degree angles for maximum versatility.



HUSQVARNA TS 73 R is a rail tile saw with high cutting capacity for all types of tile. With a durable guide rail system it provides excellent precision for cutting large tiles up to 730mm cutting length.



TS 230 F



TS 73 R



TS 66 R

TILE SAWS Husqvarna tile saws are developed for efficient and precise cutting of all kinds and sizes of tiles. They are equipped with easy to use guiding devices for precision angle cutting. Transport, set-up and operation are easily managed by one person.

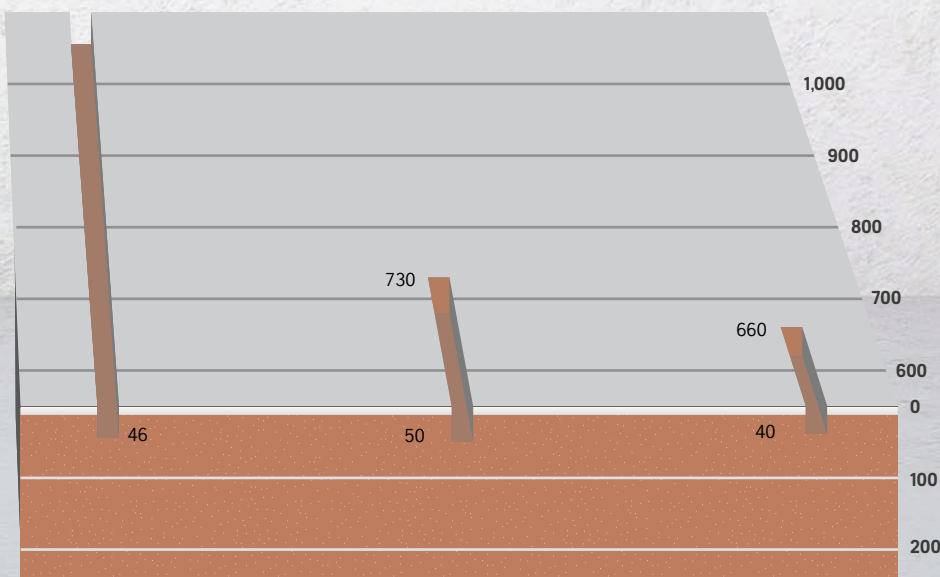

For more information, visit www.husqvarnacp.co.uk

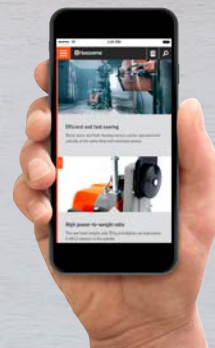



MASONRY SAWS	TS 400 F	TS 350 E
TECHNICAL SPECIFICATIONS		
Power, W	1,500/2,200	1,500/2,200
Voltage, V	115/230	115/230
Motor, Amps	14	14
Plug size, Amps	16	16
Cycles, Hz	50	50
Blade shaft, rpm	2,800	2,800
Max blade diameter, mm	400	350
Max depth of cut, mm	125/230	100
Max length of cut, mm	700	700
Arbor size, mm	25.4	25.4
Dimensions (L×W×H), mm	1,120×600×600	1,120×600×600
Weight, kg	96.0	92.0
FEATURES		
No volt release switch	●	●
Plunging head	●	●
Blade shaft wrench	●	●
Straight cutting guide	●	●
Water pump	●	●
Quick-connect electric pump	●	●
Transport wheels	4	2
Angle cutting guide	●	●
Quick disconnect flange	●	—
Folding legs	●	●
Blade adaptation 300–350 mm	●	●
Blade adaptation 300, 350 and 400 mm	●	—
GENERATOR AND TRANSFORMER INFORMATION		
Minimum transformer size, VA	2,000	2,000
Transformer continuous or intermittent	Either	Either
Minimum generator required, k VA	4.5	4.5
ARTICLE INFORMATION		
	965 14 81-07, 110 V, 1-phase, high-quality blade	965 14 80-03, 110 V, 1-phase, high-quality blade
	965 14 81-01, 230 V, 1-phase, high-quality blade*	965 14 80-01, 230 V, 1-phase, high-quality blade*
RRP EXC VAT	110 V – £1,368.04 230 V – £1,504.77	110 V – £1,082.04 230 V – £1,168.18

* 230 V machines are special order only



TILE SAWS	TS 230 F	TS 73 R	TS 66 R
TECHNICAL SPECIFICATIONS			
Power, W	750	1,000	800
Voltage, V	115/230	115/230	230
Cycles, Hz	50	50	50
Max blade diameter, mm	230	230	200
Max depth of cut, mm	46/37*	50/100	40
Max length of cut, mm	—	730	660
Arbor size, mm	25.4	25.4	25.4
Dimensions (L×W×H), mm	630×520×330	1,060×575×600	950×480×490
Weight, kg	16.5	47.0	41.0
FEATURES			
Blade shaft wrench	●	●	●
Angle cutting guide	●	●	●
Adjustable cutting guide	●	●	●
Water pump	—	●	●
Plunging head	—	●	●
Side extension for table	—	●	●
Incl. blade with continuous rim	●	●	●
GENERATOR AND TRANSFORMER INFORMATION			
Minimum transformer size, VA	1,000	1,250	—
Transformer continuous or intermittent	Either	Either	—
Minimum generator required, k VA	2.4	3.0	2.4
ARTICLE INFORMATION			
	965 15 36-02, 110 V	965 15 38-01, 110 V	
	965 15 36-01, 230 V**	965 15 38-02, 230 V**	965 15 37-01, 230 V**
RRP EXC VAT	110 V - £ 517.12 230 V - £ 545.30	110 V - £ 732.68 230 V - £ 808.66	£ 513.97

*At 45° miter cut.

** 230 V machines are special order only

**TAKE CARE OF CONCRETE
DUST AND SLURRY IN A SMART
EASY AND EFFICIENT WAY!**

SEE THE SYSTEMS GUIDE ON PAGE 68

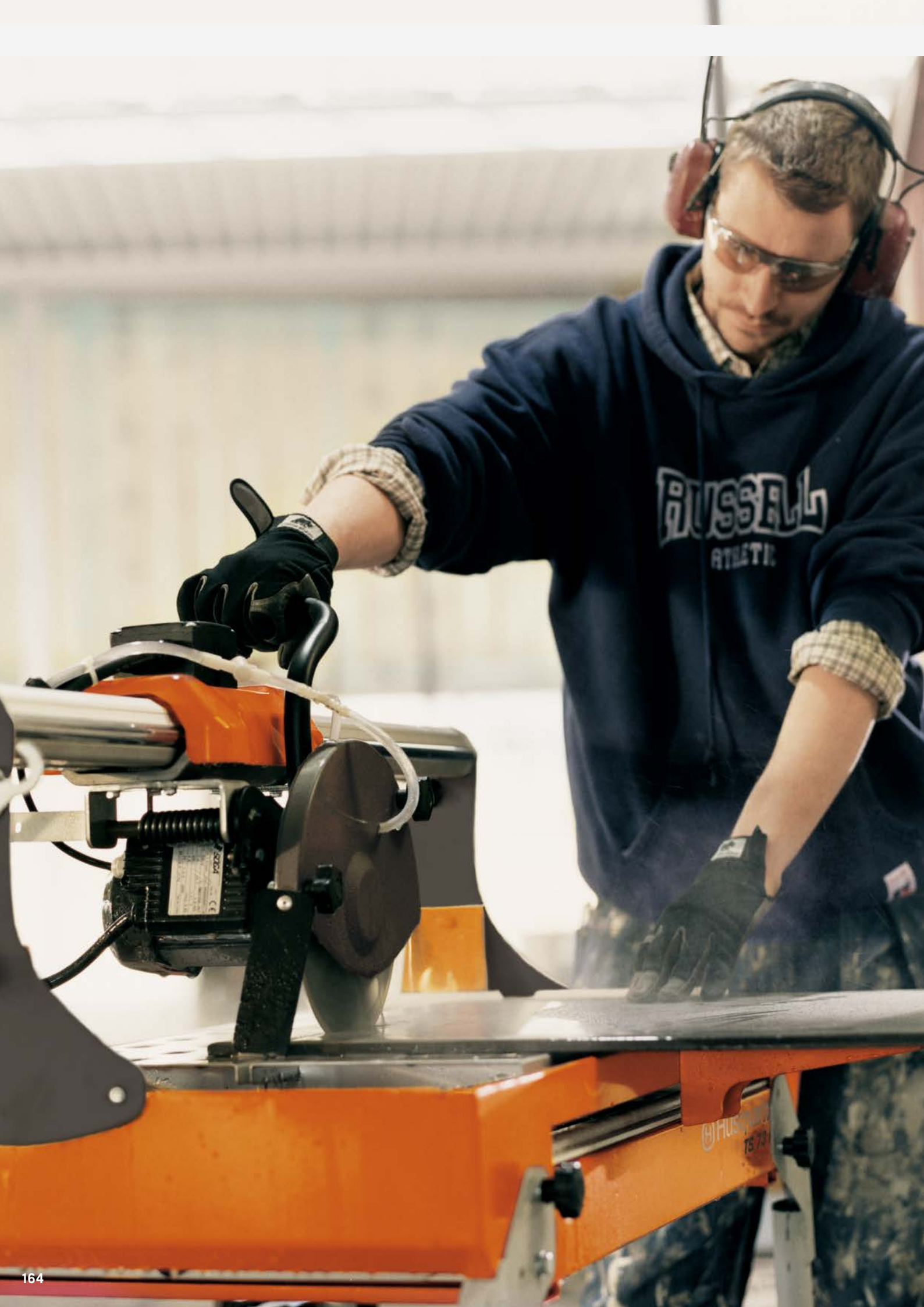



1 Quick connection nut for blade, for easy installation of the blade



2 Angle cutting guide for TS 300 E



3 Angle cutting guide for TS 73 R

4 Complete cutting guide and angle cutting guide



5 Sharpening block, 2 sides



6 Side support



7 Laser guide kit (TS 400 F)



8 Foldable trestle for easier working conditions

Husqvarna TS 400 F.

ACCESSORIES AND SPARE PARTS		RRP	EXC VAT
1	Quick connection nut for blade	543 04 33-57	£ 22.91
2	Angle cutting guide	543 04 61-46	£ 25.46
5	Sharpening block, 2 sides	543 05 91-20	£ 9.18
7	Laser guide kit	540 06 62-01	£ 145.44
	Plug for tank	543 04 60-51	£ 2.67
	Water pump, 230/400 V	587 49 22-01	£ 104.08
	Water pump, 110 V	587 49 22-04	£ 75.29

Husqvarna TS 350 E.

ACCESSORIES AND SPARE PARTS		RRP	EXC VAT
1	Blade nut	543 85 01-75	£ 1.57
2	Angle cutting guide	543 04 61-46	£ 25.46
5	Sharpening block, 2 sides	543 05 91-20	£ 9.18
	Plug for tank	543 04 60-51	£ 2.67
	Water pump, 230/400 V	587 49 22-01	£ 104.08
	Water pump, 110 V	587 49 22-04	£ 75.29
	Wrench, blade nut	543 04 59-00	£ 5.76

Husqvarna TS 230 F.

ACCESSORIES AND SPARE PARTS		RRP	EXC VAT
1	Blade nut	501 17 99-01	£ 1.89
2	Angle cutting guide	543 04 62-73	£ 2.82
4	Complete cutting guide	543 04 62-74	£ 42.00
5	Sharpening block, 2 sides	543 05 91-20	£ 9.18
8	Trestle	543 07 20-29	£ 121.25

Husqvarna TS 73 R.

ACCESSORIES AND SPARE PARTS		RRP	EXC VAT
1	Blade nut	543 07 20-02	£ 3.23
3	Angle cutting guide	543 06 98-41	£ 16.83
5	Sharpening block, 2 sides	543 05 91-20	£ 9.18
6	Side support	544 94 53-01	£ 5.48
	Plug water tray	543 04 60-51	£ 2.67
	Water pump, 230 V	587 49 22-02	£ 82.98
	Water pump, 115 V	587 49 22-05	£ 80.42
	Wrench, blade nut	543 04 58-95	£ 1.76

Husqvarna TS 66 R.

ACCESSORIES AND SPARE PARTS		RRP	EXC VAT
1	Blade nut	543 85 03-28	£ 0.28
5	Sharpening block, 2 sides	543 05 91-20	£ 9.18
	Water pump	543 04 05-03	£ 16.32

For complete list of spare parts see Illustrated Part List (IPL) on our web site.

DIAMOND BLADES FOR MASONRY AND TILE SAWING

Developed for intensive use, this professional range is optimised for particularly demanding work environments and materials, from hard ceramic tiles to highly abrasive low-density bricks and blocks. The features originate in our global experience of heavy-duty jobs. The blade range accommodates several low-noise core blades with a special steel core that reduces noise by 50% compared to regular blades, highly recommended by operators as well as people nearby.

GOLD
BRONZE

See pages 14–15 for more information.



ELITE-CUT

TACTI-CUT

PRODUCT	ELITE-CUT		TACTI-CUT
	GS 2	GS 50	GS 2
SEGMENT SHAPE			
MATERIAL			
Glass	—	—	—
Hard tiles, porcellanato	●●●	—	●●●
Ceramic tiles	●●●	●	●●●
Granite, hard	●●	●	●
Marble	●●	●	●
Granite, soft	●●	●●	●●
Concrete	—	●●●	—
Brick	—	●●●	—
Abrasive materials	—	●●	—
RECOMMENDED EQUIPMENT	TS 350 E, TS 230 F, TS 73 R, TS 66 R	TS 400 F, TS 350 E	TS 350 E, TS 230 F, TS 73 R, TS 66 R.

●●● = Optimal ●● = Good ● = Acceptable — = Not recommended

Husqvarna Elite-Cut table saw blades.

Gold level tile and masonry sawing blades with a very wide window of application to cut most materials.

PRODUCT NUMBER	DIAMETER, MM	BLADE GEOMETRY	SEGMENT SHAPE	SEGMENT HEIGHT, MM	BORE, MM	OTHER	RRP EXC VAT
GS 2							
579 80 34-60	180	Continuous	Flat	10.0	25.4	Silence core	£ 45.45
579 80 34-70	200	Continuous	Flat	10.0	25.4	Silence core	£ 56.43
579 80 34-80	230	Continuous	Flat	10.0	25.4	Silence core	£ 68.01
579 80 34-90	250	Continuous	Flat	10.0	25.4	Silence core	£ 71.00
579 79 81-10	300	Continuous	Flat	10.0	25.4	Silence core	£ 111.10
579 79 81-20	350	Continuous	Flat	10.0	25.4	Silence core	£ 128.93
GS 50							
579 80 41-10	300	Segmented	Flat	12.0	25.4	Silence core	£ 103.89
579 80 41-20	350	Segmented	Flat	12.0	25.4	Silence core	£ 197.96
579 80 41-30	400	Segmented	Flat	12.0	25.4	Silence core	£ 217.15
579 80 41-60	500	Segmented	Flat	12.0	25.4	—	£ 333.30
579 80 41-70	600	Segmented	Flat	12.0	25.4	—	£ 474.70
579 80 41-80	900	Segmented	Flat	12.0	60.0	—	£ 710.03
579 80 41-90	1,000	Segmented	Flat	12.0	60.0	—	£ 862.54

Husqvarna Tacti-Cut table saw blades.

Quality tile sawing blades developed for less intensive professional use, providing a good balance between performance and price.

PRODUCT NUMBER	DIAMETER, MM	BLADE GEOMETRY	SEGMENT SHAPE	SEGMENT HEIGHT, MM	BORE, MM	RRP EXC VAT
GS 2						
579 80 36-40	125	Continuous	Flat	10.0	22.2	£ 10.95
579 80 36-60	180	Continuous	Flat	10.0	25.4	£ 28.03
579 80 36-80	230	Continuous	Flat	10.0	25.4	£ 33.63
579 80 36-91	250	Continuous	Flat	10.0	25.4	£ 41.11

Blade diameters are nominal.



HIGH PERFORMANCE, COMPACT SIZE ROBOTS FOR SAFE DEMOLITION

Our remote-controlled demolition robots are market leaders, featuring high power, low weight and functional design. They are the obvious choice for users who want manoeuvrable yet highly powerful, stable machines with long reach. Our DXR machines have a modern and easy-to-use remote control, with class-leading user-friendliness and well-considered design. All this, combined with our experience, know-how and global presence mean you are also assured of highly accessible and competent service and support.



For more information, visit www.husqvarnacp.co.uk

DXR USER GUIDE See Husqvarna DXRs in action and learn how to master them at www.dxruserguide.com



Range overview.

The range of Husqvarna demolition robots consists of four basic models, from the 15 kW DXR 140 with its endless 360°+ rotating arm to the 22 kW DXR 310 with telescopic arm. Weights range from 985 kg to 2,020 kg. With the feature packages, the DXR range is available in 14 different variants. For maximum productivity, choose the optimal configuration for your kind of operation.

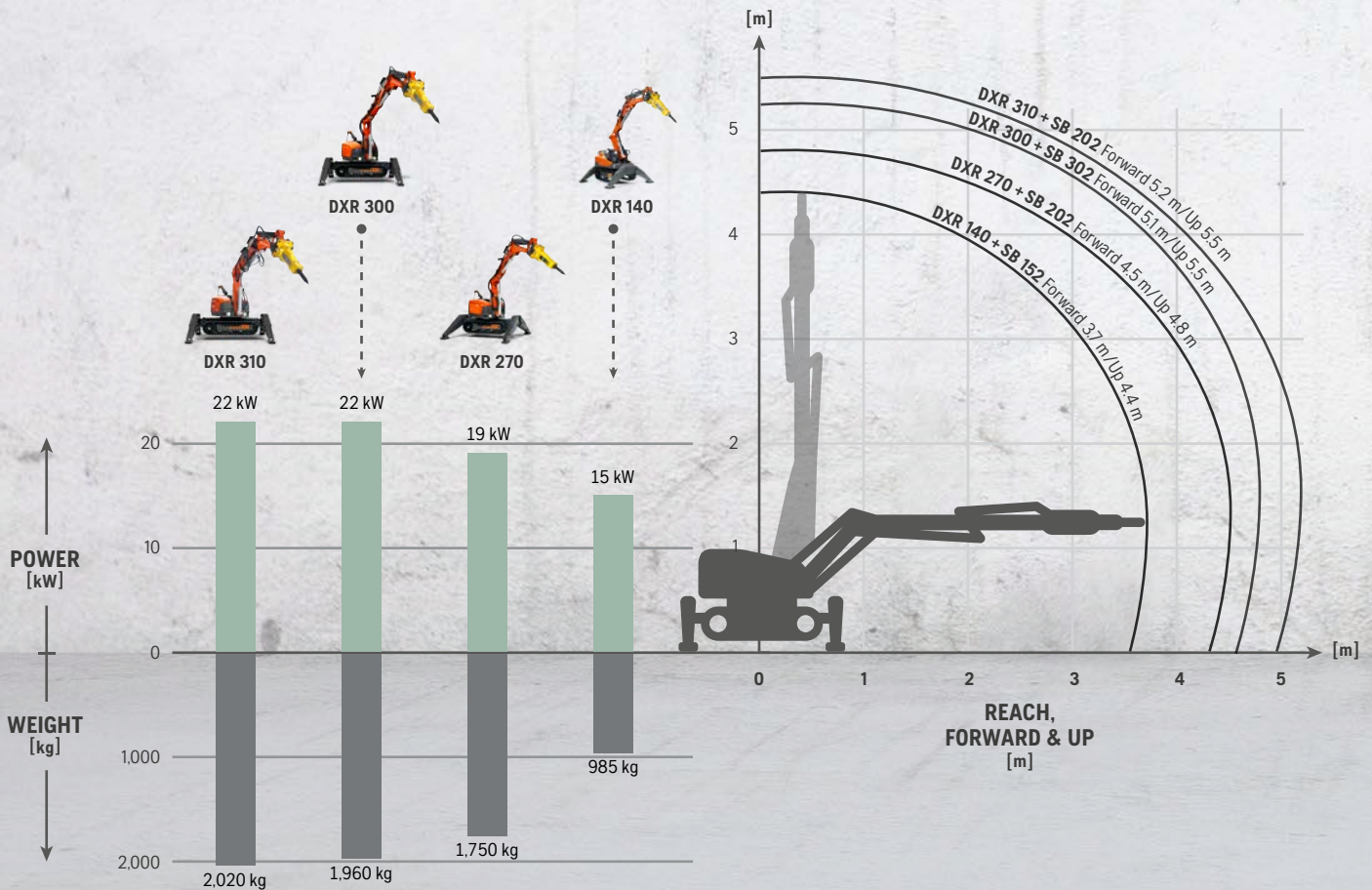



COMPACT The narrow width allows the machine to pass through standard door openings. The low height provides good visibility over the machine when you work, making operation more efficient and safer as well as lowering the machine's centre of gravity. The outriggers have extra wide span for superior stability and high workload.

VERSATILE Featuring a wide and expanding range of attachable tools and accessories, Husqvarna DXR machines are useful and efficient for virtually all heavy and hazardous work on any construction or refurbishing site: Breaking, chiselling, crushing, shearing, digging, shovelling, grappling, drum cutting... you name it!



WIRELESS The remote control for the Husqvarna DXR is one of the market's most modern and easy-to-use model, delivering a unique user-friendly and well-considered design. It controls everything the machine does, simply and conveniently. The control box uses industrial Bluetooth technology and is equipped with a 3.5-inch colour display that is easy to read.



PRODUCTIVE These machines have a high power-to weight ratio. They are easy to operate thanks to smart functional design, innovative engineering and hi-tec technology. They move quickly into position and are ready to start work without time-consuming preparation.

FACTORY-INSTALLED FEATURE PACKAGES FOR ADDED PRODUCTIVITY

Now you can order your Husqvarna DXR to be delivered with additional features for increased precision, performance and protection. Installing these packages in the clean factory environment saves time and money and maximises the quality of the installation. Three feature packages are currently available from the factory: P1, P2 and P3. (The included components are also available for aftermarket installation.) Visit www.husqvarnacp.co.uk for more information.

HYDRAULIC FEATURE (P1)

ENHANCED COOLING (P2)

HEAT PROTECTION (P3)



ENHANCED COOLING (P2)

Allows the DXR to work continuously with full power in higher ambient temperatures, enabling higher productivity in various applications such as cement kilns and steel factories. Available for DXR 310, DXR 300 and DXR 270.

P2

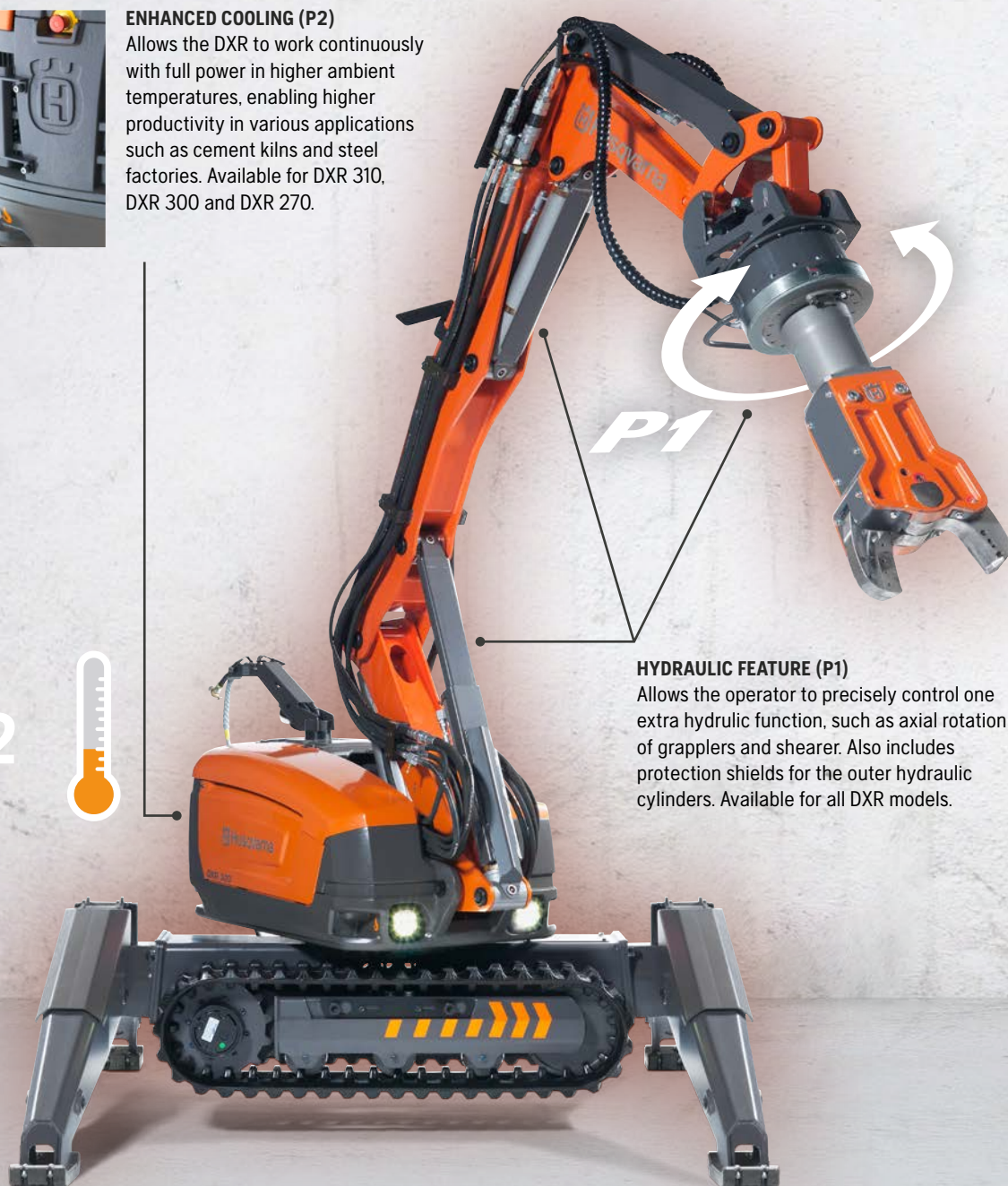

P1

HYDRAULIC FEATURE (P1)

Allows the operator to precisely control one extra hydraulic function, such as axial rotation of grapples and shearer. Also includes protection shields for the outer hydraulic cylinders. Available for all DXR models.

Hydraulic kit for extra functions

Cylinder protection kit (C2+C3)

Attachment kit cooling package

Hose protection

Fire resistant hydraulic oil

Steel tracks

Steel feet

Cooling extension kit for hammer

Heat protection kit for SB202/
SB302 (ordered separately)

● ●	● ●							
●	●	● ●						
●	●	●	● ●	●	● ●	● ●	● ●	● ●

● = Factory installation

● = Aftermarket installation

HEAT PROTECTION (P3) Allows the DXR to be used for de-slugging in hot melting plants and similar applications. Protects vital parts from damage caused by radiant heating as well as conduction heating. Available for DXR 270, DXR 300 and DXR 310.



Steel tracks



Steel feet

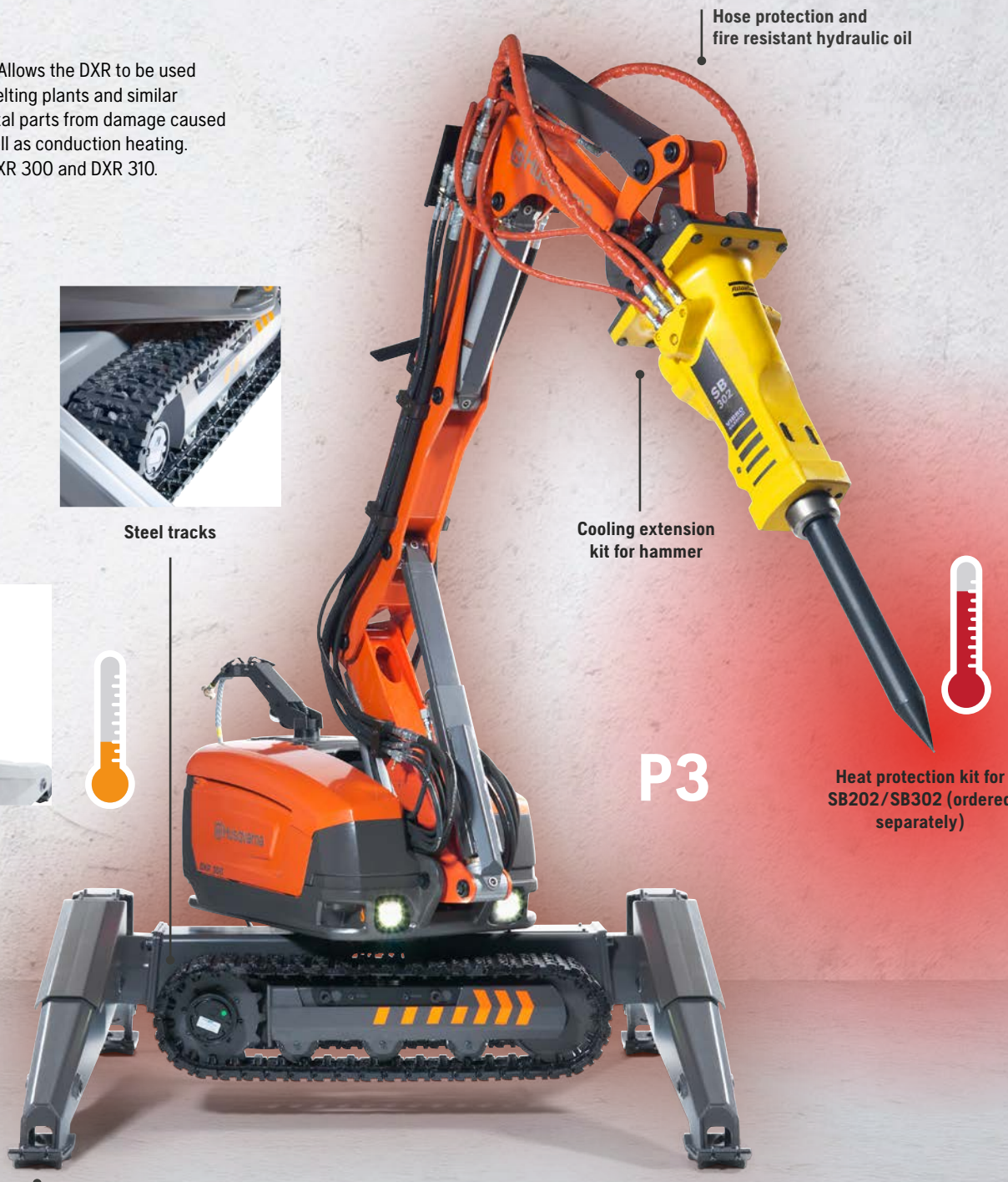

Hose protection and fire resistant hydraulic oil

Cooling extension kit for hammer

P3



Heat protection kit for SB202/ SB302 (ordered separately)



DEMOLITION ROBOTS	DXR 310	DXR 300
TECHNICAL SPECIFICATIONS		
Power, kW	22	22
Weight, kg	2.020	1.960
Reach up/forward, m*	5.5/5.2	5.5/5.1
Dozer blade/outriggers	Outriggers	Outriggers
Telescopic/non telescopic	Telescopic	Non telescopic
Flow 50/60 Hz, l/min	75	75
System pressure, nominal max, Bar	200	200
System pressure, increased max, Bar	250	250
Variable flow to tools and system, l/min	0-75	0-75
Pump type	Variable load-sensing axial piston pump	Variable load-sensing axial piston pump
Width, machine body, mm	780	780
Length, machine body, mm	2.057 (incl. outriggers)	2.057 (incl. outriggers)
Height, machine body, mm	1.035	1.035
Remote control	Portable	Portable
Communication	Bluetooth or cable	Bluetooth or cable
Range, radio	Up to 100 m	Up to 100 m
ARTICLE INFORMATION		
	965 99 53-02	967 19 56-01
	965 99 53-06, incl. hydraulic feature package (P1)	967 19 56-02, incl. hydraulic feature package (P1)
	965 99 53-07, incl. cooling package (P2)	967 19 56-03, incl. cooling package (P2)
	965 99 53-08, incl. heat protection package (P3)	967 19 56-04, incl. heat protection package (P3)
RRP EXC VAT	£ POA	£ POA

*Reach measured on machine with breaker SB 302 (DXR 300), SB 202 (DXR 310, DXR 270), SB 152 (DXR 140), from centre of rotation to tip of breaker, with machine's arm at maximum extension.



DXR 270

DXR 140

19
 1,750
 4.8/4.5
 Outriggers
 Non telescopic
 65
 200
 250
 0-65
 Variable load-sensing axial piston pump
 780
 2,057 (incl. outriggers)
 1,035
 Portable
 Bluetooth or cable
 Up to 100 m

15
 985
 4.4/3.7
 Outriggers
 Non telescopic
 52
 200
 250
 0-52
 Variable load-sensing axial piston pump
 771
 1,614 (incl. outriggers)
 854
 Portable
 Bluetooth or cable
 Up to 100 m

967 19 55-01
 967 19 55-02, incl. hydraulic feature package (P1)
 967 19 55-03, incl. cooling package (P2)
 967 19 55-04, incl. heat protection package (P3)

966 52 93-02
 966 52 93-06, incl. hydraulic feature package (P1)

€ POA

€ POA

**TAKE CARE OF CONCRETE
 DUST AND SLURRY IN A SMART
 EASY AND EFFICIENT WAY!**

SEE THE SYSTEMS GUIDE ON PAGE 68



CRUSHERS	DCR 300	DCR 100	COMMENT
TECHNICAL SPECIFICATIONS			
Weight, kg	274	192	
Max jaw opening, mm	430	425*/325**	
Crushing force, kN/t	440/45	335/34 317/32	Max power at the tips (in max opening position, crushing start)
Operation depth, mm	200	193**	Large depth which gives high operation efficiency
Rebars size, mm	30	28	
RECOMMENDED FOR			
	DXR 310/300/270	DXR 140	
ARTICLE INFORMATION			
	966 78 64-01, incl. hoses and adapter plate	966 78 63-01, incl. hoses and adapter plate	
RRP EXC VAT			
	£ POA	£ POA	

*Pins in outer pos. **Pins in inner pos.



Crusher pad for DCR 300

Crusher pad for DCR 100

Dust reduction kit, crusher

STEEL SHEARER	DSS 200
TECHNICAL SPECIFICATIONS	
Weight, kg	185
Max jaw opening, mm	200
Max crushing force, kN/t	841/85.7
Operation depth, mm	135
MAX SHEAR DIMENSIONS	
▤ Beams/profiles, mm/inch	IPE 120 (120 × 64/4.7 × 2.5)
■ Square iron, mm/inch	30 × 30/1.18 × 1.18
○ Pipe, mm/inch	75 × 5.0/2.95 × 0.20
□ Square pipe, mm/inch	60 × 60 × 5.0/2.4 × 2.4 × 0.2
└ U-beam, mm/inch	UPE 100 (55 × 100/2.2 × 3.9)
RECOMMENDED FOR	
	DXR 310/300/270/140
ARTICLE INFORMATION	
	967 27 80-01, incl. hoses and adapter plate
RRP EXC VAT	
	£ POA

ACCESSORIES DCR 300	RRP EXC VAT
Crusher pad	579 02 65-01 £ 420.57
Dust reduction kit, crusher	596 52 82-01 £ 1,279.00

SPARE PARTS DCR 300	RRP EXC VAT
Crusher tip	579 01 85-01 £ 618.71
Rebar cutting edge	579 00 93-01 £ 283.79

ACCESSORIES DCR 100	RRP EXC VAT
Crusher pad	579 02 66-01 £ 1,063.79
Dust reduction kit, crusher	596 52 82-01 £ 1,279.00

SPARE PARTS DCR 100	RRP EXC VAT
Rebar cutting edge	579 02 42-01 £ 144.53

SPARE PARTS DSS 200	RRP EXC VAT
Cutting blade, straight	587 01 94-01 £ 535.18
Cutting blade, curved	587 01 95-01 £ 535.18

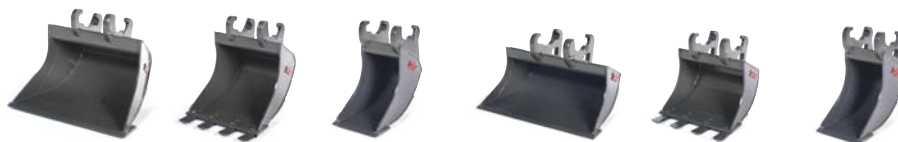

BUCKETS	DXR 310/300/270			DXR 140		
	WIDE	STANDARD	NARROW	WIDE	STANDARD	NARROW
TECHNICAL SPECIFICATIONS						
Weight, kg	90	70	50	60	58	50
Width, mm	770	520	300	770	520	300
Volume, l	105	85	40	60	55	40
ARTICLE INFORMATION						
	587 97 57-01	587 31 07-01	587 31 08-01	587 31 09-01	587 31 10-01	587 31 08-02
RRP EXC VAT						
	£ 2,460.88	£ 1,300.68	£ 1,214.87	£ 1,994.08	£ 1,248.57	£ 1,171.11

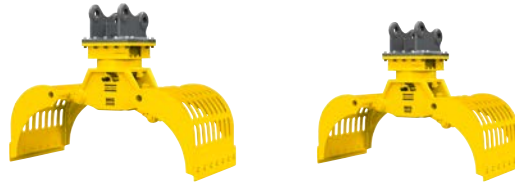

MULTI GRAPPLER	MG 200	MG 100
TECHNICAL SPECIFICATIONS		
Weight, kg	175	90
Max jaw opening, mm	750	600
Force, kN/t	15/1.5	5.9/0.6
Width, mm	450	300
RECOMMENDED FOR		
	DXR 310/300/270	DXR 140
ARTICLE INFORMATION		
	586 74 30-01, incl. hoses and adapter plate	586 74 29-01, incl. hoses and adapter plate
RRP EXC VAT	£ POA	£ POA



BREAKERS	SB 302	SB 202	SB 152
TECHNICAL SPECIFICATIONS			
Weight, kg	300	200	140
RECOMMENDED FOR			
	DXR 300	DXR 310/300/270	DXR 140
ARTICLE INFORMATION			
	586 50 13-01, incl. hoses and adapter plate 587 05 02-01, heat protection, incl. hoses and adapter plate	522 48 24-01, incl. hoses and adapter plate 580 90 21-01, heat protection, incl. hoses and adapter plate	576 18 91-01, incl. hoses and adapter plate
RRP EXC VAT	£ POA	£ POA	£ POA



Chisel cross Chisel wide Chiselmoil point Bushing Pad

ACCESSORIES SB 302	RRP EXC VAT
Heat protection kit, breaker	586 70 28-02 £ 1,878.30
Chisel cross, 76 cm	595 08 25-01 £ 1,323.75
Chisel wide, 77 cm	586 50 12-01 £ 1,335.01
Chiselmoil point, 76 cm	595 08 23-01 £ 658.26
Chiselmoil point, long, 100 cm	586 50 10-02 £ 1,302.17
Bushing Pad	590 15 25-03 £ 679.69
Dust reduction kit, breaker	583 80 72-02 £ 191.27

ACCESSORIES SB 202	RRP EXC VAT
Heat protection kit, breaker	586 70 26-02 £ 1,775.00
Chisel cross, 63 cm	595 08 24-01 £ 1,027.35
Chisel wide, 65 cm	522 86 95-03 £ 1,136.43
Chiselmoil point, 63 cm	595 08 22-01 £ 491.53
Chisel X-profile, long, 90 cm	595 08 22-02 £ 1,398.19
Bushing Pad	590 15 25-02 £ 587.84
Dust reduction kit, breaker	583 80 72-02 £ 191.27

ACCESSORIES SB 152	RRP EXC VAT
Chisel cross, 51 cm	576 63 35-02 £ 491.03
Chisel wide, 48 cm	576 63 35-03 £ 653.43
Chiselmoil point, 54 cm	595 08 21-01 £ 288.97
Bushing Pad	590 15 25-01 £ 373.52
Dust reduction kit, breaker	583 80 72-01 £ 126.61



DRUM CUTTER	DC 200
TECHNICAL SPECIFICATIONS	
Service weight, kg	200
Total width cutting head, mm	500
Diameter of cutter drum, mm	240
Number of picks, pcs	56
Maximum cutting force @ 350 bar, kN	12.6
Maximum torque @ 350 bar, kNm	1.4
Maximum rock hardness, MPA	25
RECOMMENDED FOR	
	DXR 310/300/270/140
ARTICLE INFORMATION	
	583 80 70-01, incl. hoses and adapter plate
RRP EXC VAT	£ POA

ACCESSORIES DC 200	RRP EXC VAT
Dust reduction kit, drum cutter	596 52 83-01 £ 1,639.00

Husqvarna DXR 310/ DXR 300/ DXR 270.

ACCESSORIES DXR 310		RRP	EXC	VAT
1	Hydraulic kit for extra functions*	582 71 50-01	£ 1.806.22	
2	Cylinder protection kit (C2 + C3)	586 70 13-01	£ 1.069.55	
3	Attachment kit cooling package	586 70 25-01	£ 1.324.53	
4	Attachment kit heat protection package**	582 71 54-01	£ POA	
5	Steel track, 1 pcs	579 21 73-01	£ 2.641.95	
6	Dust reduction kit, machine	583 80 71-04	£ 673.56	
7	Tool drain kit	583 80 73-04	£ 336.06	
8	Waist belt, remote control	501 79 31-01	£ 407.35	
9	Service controller	587 73 82-01	£ 1.674.67	
11	External tool hose kit	589 57 79-01	£ 966.68	
	Harness	501 79 30-01	£ 498.92	

ACCESSORIES DXR 300		RRP	EXC	VAT
1	Hydraulic kit for extra functions*	582 71 51-01	£ 1.806.22	
2	Cylinder protection kit (C2 + C3)	586 70 21-01	£ 1.069.55	
3	Attachment kit cooling package	586 70 25-01	£ 1.324.53	
4	Attachment kit heat protection package**	582 71 55-01	£ POA	
5	Steel track, 1 pcs	579 21 73-01	£ 2.641.95	
6	Dust reduction kit, machine	583 80 71-03	£ 668.59	
7	Tool drain kit	583 80 73-04	£ 336.06	
8	Waist belt, remote control	501 79 31-01	£ 407.35	
9	Service controller	587 73 82-01	£ 1.674.67	
11	External tool hose kit	589 57 79-01	£ 966.68	
	Harness	501 79 30-01	£ 498.92	

ACCESSORIES DXR 270		RRP	EXC	VAT
1	Hydraulic kit for extra functions*	582 71 52-01	£ 1.806.22	
2	Cylinder protection kit (C2 + C3)	586 70 21-01	£ 1.069.55	
3	Attachment kit cooling package	586 70 27-01	£ POA	
4	Attachment kit heat protection package**	582 71 57-01	£ POA	
5	Steel track, 1 pcs	579 21 73-01	£ 2.641.95	
6	Dust reduction kit, machine	583 80 71-02	£ 670.93	
7	Tool drain kit	583 80 73-02	£ 304.47	
8	Waist belt, remote control	501 79 31-01	£ 407.35	
9	Service controller	587 73 82-01	£ 1.674.67	
11	External tool hose kit	589 57 79-01	£ 966.68	
	Harness	501 79 30-01	£ 498.92	

SPARE PARTS		RRP	EXC	VAT
	Battery	587 31 16-02	£ 168.21	
	Battery charger	510 28 50-03	£ 119.35	
	Breaker grease	521 91 77-01	£ 27.00	
	Cable, remote control	589 86 04-01	£ 187.00	
	Multi Advanced grease	588 81 48-01	£ 13.75	
	Oil filter	510 14 45-01	£ 73.55	
	Quick coupling grease, female	510 26 78-01	£ 27.41	
	Quick coupling grease, male	510 26 79-01	£ 40.59	
	Quick coupling tool, female	510 26 81-01	£ 141.76	
	Quick coupling tool, male	510 26 80-01	£ 106.39	
	Rubber foot	587 18 63-03	£ 141.88	
	Rubber tracks	505 26 87-01	£ 265.32	
	Socket 63 A (female)	531 11 71-32	£ 97.06	
	Socket 63 A (male)	510 27 77-01	£ 118.68	
	Steel foot	587 18 63-01	£ 182.98	

Husqvarna DXR 140.

ACCESSORIES		RRP	EXC	VAT
1	Hydraulic kit for extra functions*	582 71 53-01	£ 2.815.66	
2	Cylinder protection kit (C2 + C3)	586 70 20-01	£ 1.069.55	
6	Dust reduction kit, machine	583 80 71-01	£ 552.57	
7	Tool drain kit	583 80 73-01	£ 336.06	
8	Waist belt, remote control	501 79 31-01	£ 407.35	
9	Service controller	587 73 82-01	£ 1.674.67	
10	Counterweight	579 39 44-01	£ 419.05	
11	External tool hose kit	589 57 79-01	£ 966.68	
	Adapter plate DSS 200	586 41 67-01	£ 1.199.95	
	Adapter plate DC 200	588 61 14-01	£ 1.226.02	
	Harness	501 79 30-01	£ 498.92	

SPARE PARTS		RRP	EXC	VAT
	Battery	587 31 16-02	£ 150.42	
	Battery charger	510 28 50-03	£ 119.35	
	Breaker grease	521 91 77-01	£ 27.00	
	Cable, remote control	589 86 04-01	£ 187.00	
	Multi Advanced grease	588 81 48-01	£ 13.75	
	Oil filter	574 71 39-01	£ 53.57	
	Quick coupling grease, female	510 26 78-01	£ 27.41	
	Quick coupling grease, male	510 26 79-01	£ 40.59	
	Quick coupling tool, female	510 26 81-01	£ 141.76	
	Quick coupling tool, male	510 26 80-01	£ 106.39	
	Rubber foot	587 18 63-03	£ 141.88	
	Rubber tracks	579 32 84-01	£ 124.07	
	Socket 32 A (female)	531 11 71-31	£ 22.95	
	Socket 32 A (male)	510 27 77-02	£ 143.88	
	Steel foot	587 18 63-01	£ 182.98	

*Hydraulic kit for extra functions is necessary to be able to use the MG 200, MG 100 and DSS 200.

**Oil not included.



1 Hydraulic kit for extra function

2 Cylinder protection kit (C2+C3)



3 Attachment kit cooling package



4 Attachment kit heat protection package



5 Steel track



7 Tool drain kit



9 Service controller



11 External tool hose kit



6 Dust reduction kit, machine



8 Waist belt for remote control



10 Counterweight



HOURS OF BUSINESS

Monday to Friday – 8.30 am to 5.00 pm

TERMS AND CONDITIONS

Husqvarna UK "Terms and Conditions of Sale and Supply" apply to all items shown in this price list. (A copy is available on request.)

Apart from the carriage charges listed below, all orders for spare parts, accessories and diamond products placed on-line via web ordering will be carriage free. All orders for hire and distribution placed either by fax, telephone or email will be subject to a £ 4.50 administration charge.

A further freight charge of £ 15.00 is applied to spares/accessories and diamond blade deliveries direct to addresses not held on our database. For machines, charges are available on request.

For WebOrder visit weborder.husqvarna.com, for more information contact customer services or your local area manager. WebOrder is only available for current account customers.

Returned items will only be accepted if agreed prior to return, are not corroded or marked and are in a saleable new condition (contact HCP customer services for a returns authorisation number). If agreed the following applies: Standard items will only be subject to a 15 % handling charge, Non-standard special order products/spare parts/accessories as well as specially manufactured cores are non-returnable and will not be accepted back for credit.

VAT is charged at the current rate.

Prices quoted in this price list are correct at the time of going to print, but are subject to change without prior notice. The most up to date version of our price list can be found on our website, www.husqvarnacp.co.uk

We will endeavour to despatch the same day for all orders placed before 2.00 pm

Pallet deliveries will take between 2 and 3 working days.

CARRIAGE CHARGES

Spare part Next Day delivery before 10.30 am.....	£ 17.50
Spare part Next Day delivery before 12.00 pm.....	£ 12.00
Spare part Saturday delivery.....	£ 35.00
Machine and oil orders via special delivery.....	£ POA

Scotland	07836 518045
North East	07836 518019
East Midlands, North West, Central England & Wales	07710 302297
North London, Home Counties & East Anglia (Hire & Distribution)	07710 302265
North London, Home Counties & East Anglia (Professional Contractors) ..	07710 301075
South West & South Wales.....	07770 955091
London & South East (Hire & Distribution).....	07984 596386
London & South East (Professional Contractors).....	07710 301243
Northern Ireland.....	07710 302292
Business Development Manager – Surface Preparation	07341 730826
Key Account Manager.....	07836 255607
National Field Sales Manager – Hire and Distribution	07710 302294
National Field Sales Manager – Professional Contractors	07860 921224

Addresses:

GLOUCESTER HEAD OFFICE

Unit 4 Glenmore Centre,
Waterwells Business Park
Quedgeley
Gloucester
GL2 2AP

LEEDS SERVICE CENTRE

Howley Park Road East,
Morley,
Leeds,
LS27 0SW

MAIDSTONE SERVICE CENTRE

Liphook Way,
20/20 Business Park,
Allington,
Maidstone,
Kent,
ME16 0LQ

ACCOUNTS

Preston Road
Aycliffe Business Park
Newton Aycliffe
Co. Durham
DL5 6UP

Contact Numbers:

CUSTOMER SERVICES TEL

0344 844 4569

CUSTOMER SERVICES FAX

0844 844 4568

TECHNICAL/ AFTER-SALES SUPPORT

0344 844 4569

ACCOUNTS

0844 844 4571*

* Calls cost 7p per minute from a BT landline, charges from other operators will vary and calls from mobiles will cost considerably more.

EMAIL

husqvarna.construction@husqvarna.co.uk

WEBSITE

www.husqvarnacp.co.uk

SAFE OPERATING SPEEDS FOR DIAMOND BLADES AND DIAMOND CORE DRILL

SAFE OPERATING SPEEDS FOR DIAMOND BLADES		
DIAMETER	OPTIMUM SPEED	MAXIMUM SPEED
100 mm	9072 rpm	15000 rpm
115 mm	8063 rpm	13300 rpm
125 mm	7257 rpm	12000 rpm
152 mm	6048 rpm	10185 rpm
180 mm	5184 rpm	8730 rpm
203 mm	4536 rpm	7640 rpm
230 mm	4000 rpm	6800 rpm
250 mm	3629 rpm	6115 rpm
300 mm	3024 rpm	(80 mps) 5100 rpm
300 mm	3024 rpm	(100 mps) 6370 rpm
350 mm	2600 rpm	(80 mps) 4370 rpm
350 mm	2600 rpm	(100 mps) 5460 rpm
400 mm	2300 rpm	(80 mps) 3820 rpm
400 mm	2300 rpm	(100 mps) 4780 rpm
450 mm	2000 rpm	3400 rpm
500 mm	1800 rpm	3050 rpm
600 mm	1500 rpm	2550 rpm
650 mm	1400 rpm	2350 rpm
700 mm	1300 rpm	2190 rpm
750 mm	1200 rpm	2050 rpm
800 mm	1132 rpm	1910 rpm
900 mm	1000 rpm	1700 rpm
1000 mm	900 rpm	1530 rpm
1200 mm	750 rpm	1275 rpm

SAFE OPERATING SPEEDS FOR DIAMOND CORE DRILLS			
DIAMETER	OPTIMUM SPEED	MINIMUM SPEED	MAXIMUM SPEED
20 mm	2500 rpm	2000 rpm	3000 rpm
41 mm	1400 rpm	1100 rpm	1700 rpm
52 mm	900 rpm	600 rpm	1100 rpm
82 mm	650 rpm	500 rpm	750 rpm
102 mm	500 rpm	450 rpm	650 rpm
127 mm	475 rpm	375 rpm	550 rpm
152 mm	375 rpm	300 rpm	475 rpm
162 mm	325 rpm	275 rpm	400 rpm
178 mm	285 rpm	250 rpm	325 rpm
210 mm	250 rpm	225 rpm	300 rpm
225 mm	225 rpm	200 rpm	275 rpm
250 mm	215 rpm	190 rpm	260 rpm
300 mm	175 rpm	150 rpm	200 rpm
350 mm	150 rpm	125 rpm	185 rpm

HUSQVARNA CORE DRILL RPM'S

HUSQVARNA CORE DRILL RPM'S			
CORE DRILL	GEAR POSITION	RPM	CORE DIAMETERS
DM 220/DM 230	1	580	80 > 150 mm
	2	1400	40 > 80 mm
	3	2900	< 40 mm
DMS 240	1	185	80 > 250 mm
	2	455	40 > 80 mm
DM 340	1	240	200 > 400 mm
	2	540	100 > 200 mm
	3	930	50 > 100 mm
DM 406HL	1	120	400 > 600 mm
	2	230	250 > 400 mm
	3	340	150 > 250 mm
	4	580	90 > 150 mm
	5	980	50 > 90 mm
	6	1400	< 50 mm

HUSQVARNA CORE DRILL RPM'S DM 650 HIGH FREQUENCY			
MECHANICAL GEAR	ELECTRONIC GEAR	RPM	CORE DIAMETERS
1	1	126	600 mm
1	2	135	550 mm
1	3	144	500 mm
1	4	155	450 mm
1	5	167	425 mm
1	6	181	400 mm
1	7	198	350 mm
1	8	218	325 mm
1	9	242	300 mm
2	1	273	275 mm
2	2	293	250 mm
2	3	312	225 mm
2	4	335	210 mm
2	5	361	200 mm
2	6	390	182 mm
2	7	421	172 mm
2	8	457	152 mm
2	9	502	112 mm



 Husqvarna

DXR 140

A photograph of a workshop or warehouse interior. In the center, there is a large metal shelving unit with multiple levels. The top level holds a few boxes. The middle section is filled with many small, blue plastic bins. To the right of the shelving unit, there is a workbench with a chainsaw on it. The floor is a dark, polished concrete. The lighting is bright, and the overall scene is organized and professional.

Husqvarna Construction Products is a world leader when it comes to equipment and diamond tools for the construction and stone industry. We provide professional users all over the world with efficient and reliable equipment, so that they can be proud of a job well done. Proud professionals are our best reward.

www.husqvarnacp.co.uk



 **Husqvarna**[®]

www.husqvarnacp.co.uk

Copyright © 2019 Husqvarna AB (publ). All rights reserved. Husqvarna and other product and feature marks are trademarks of the Husqvarna Group. We reserve the right to make changes in technology and specifications without prior notice.